



T&S BRASS AND BRONZE WORKS, INC.

2 Saddleback Cove / P.O. Box 1088
Travelers Rest, SC 29690

Model No.

B-1106

Item No.

Travelers Rest, SC: 800-476-4103 • Simi Valley, CA: 800-423-0150 • Fax: 864-834-3518 • www.tsbrass.com



ADA Compliant

This Space for Architect/Engineer Approval

Job Name _____ Date _____

Model Specified _____ Quantity _____

Customer/Wholesaler _____

Contractor _____

Architect/Engineer _____

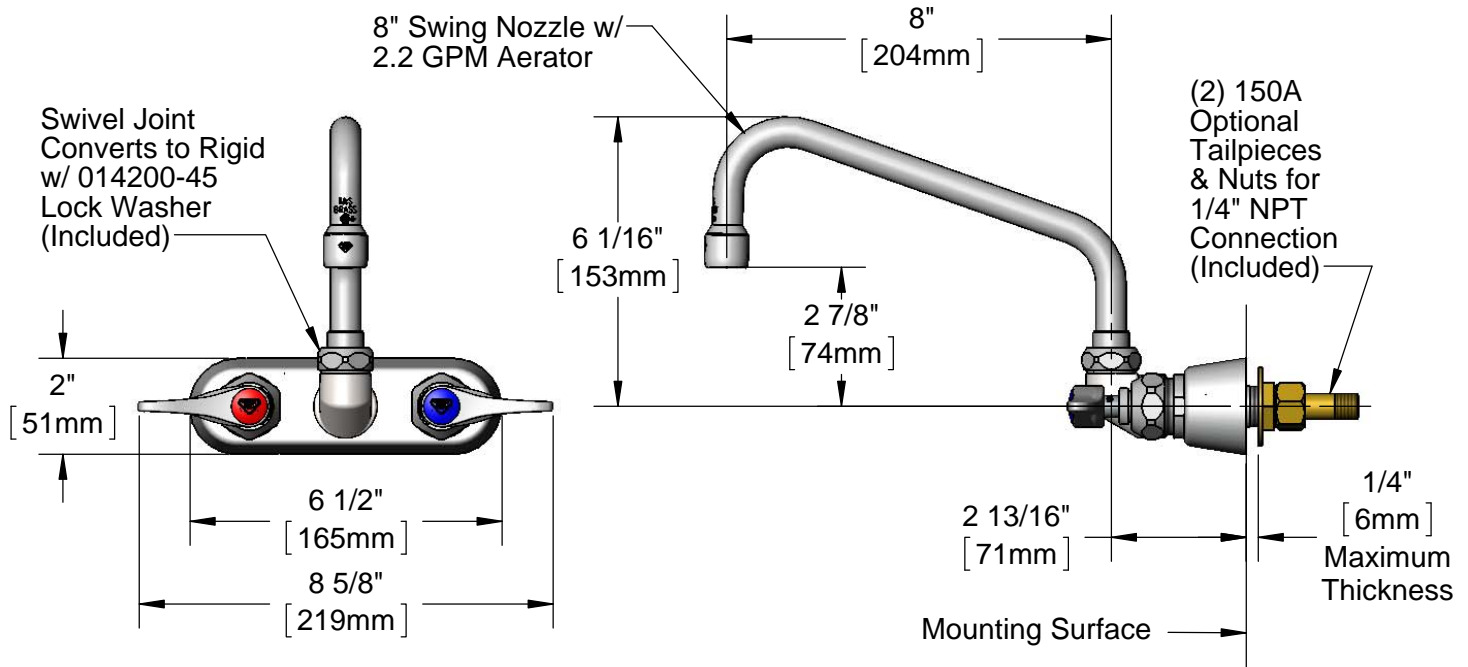
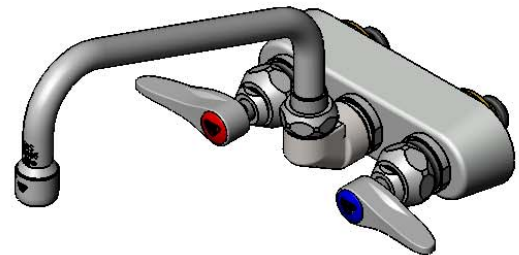
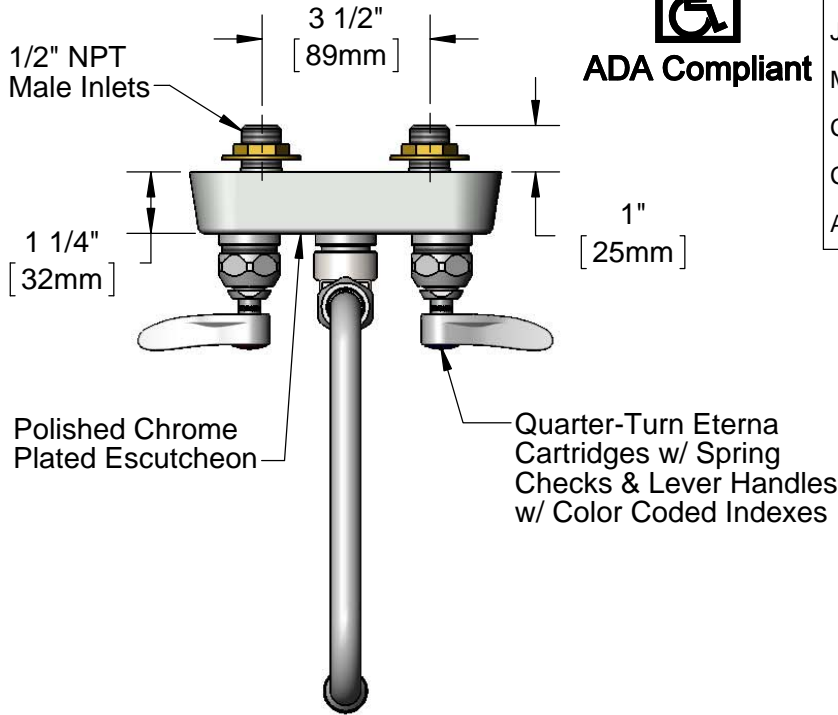

Rough-In Requirement:
(2) ϕ 1" [25mm] Mounting Holes

Product Specifications:
3 1/2" Wall Mount Workboard Faucet, Quarter-Turn Eterna Cartridges w/ Spring Checks, Lever Handles, 8" Swing Nozzle, 2.2 GPM Aerator & 1/2" NPT Male Inlets

Product Compliance:
ASME A112.18.1 / CSA B125.1
NSF 61 - Section 9
NSF 372 (Low Lead Content)
ANSI A117.1 (ADA)



T&S BRASS AND BRONZE WORKS, INC.

2 Saddleback Cove / P.O. Box 1088
Travelers Rest, SC 29690

Model No.

B-1106

Item No.

Travelers Rest, SC: 800-476-4103 • Simi Valley, CA: 800-423-0150 • Fax: 864-834-3518 • www.tsbrass.com

ITEM NO.	SALES NO.	DESCRIPTION
1	B-0199-01	2.2 GPM Aerator, 55/64"-27 UN Female
2	060X-A22	8" Swing Nozzle w/ 2.2 GPM Aerator
3	019360-40	Swivel Nut (New Style)
4	009538-45	Swivel Washer
5	011429-45	Swivel Sleeves (2)
6	001074-45	O-Ring
7	019382-40	Quarter-Turn New Style Eterna Cartridge w/ Spring Check, LTC
8	150A	1/4" NPT Tailpiece & Nut
9	002954-45	Shank Lock Nut
10	000999-45	Brass Lock Washer
11	019356-40	B-1100 Eterna Workboard Escutcheon
12	019376-40	Escutcheon Lock Nut
13	019383-40	Quarter-Turn New Style Eterna Cartridge w/ Spring Check, RTC
14	019361-45	Lever Handle (New Style)
15	000925-45	Lab Handle Screw
16	019363-45	Blue Button Index, Press-in
17	001017-45	Washer
18	000082-40	B-1100 Knob
19	014200-45	Star Washer, Anti-Rotation
20	019364-45	Red Button Index, Press-in

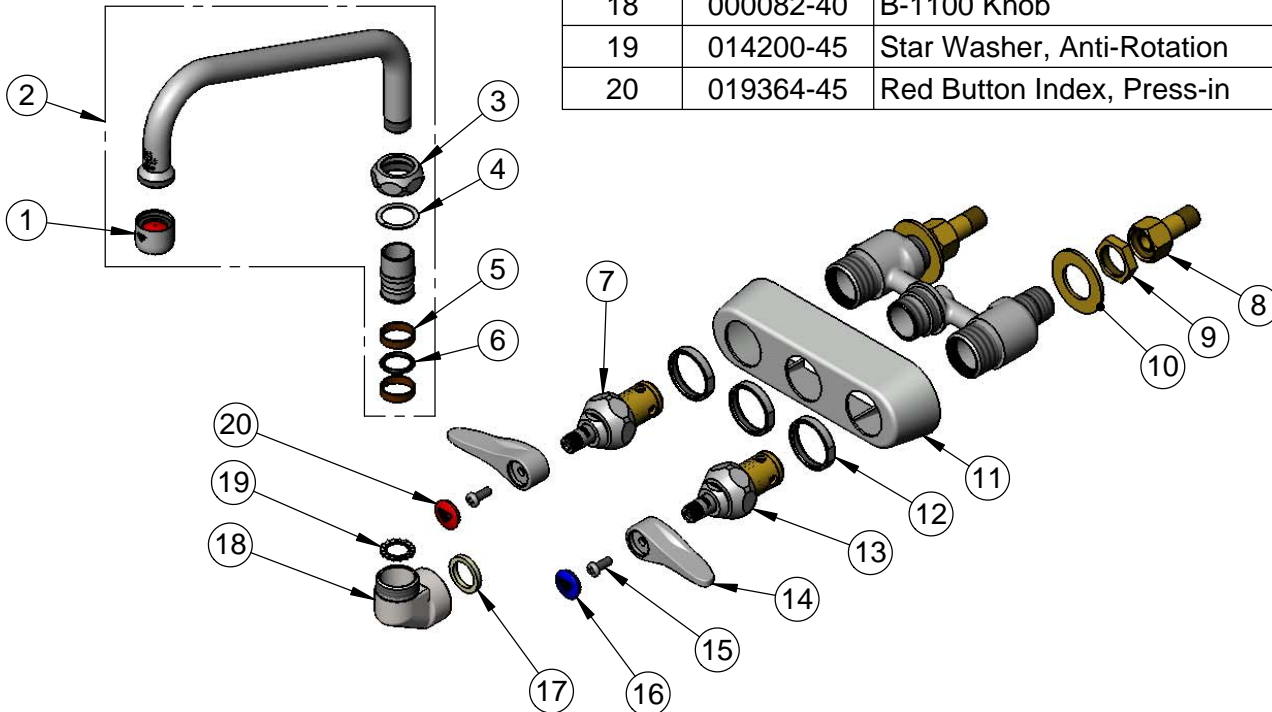

Product Specifications:

3 1/2" Wall Mount Workboard Faucet, Quarter-Turn Eterna Cartridges w/ Spring Checks, Lever Handles, 8" Swing Nozzle, 2.2 GPM Aerator & 1/2" NPT Male Inlets

Product Compliance:

ASME A112.18.1 / CSA B125.1
NSF 61 - Section 9
NSF 372 (Low Lead Content)
ANSI A117.1 (ADA)