

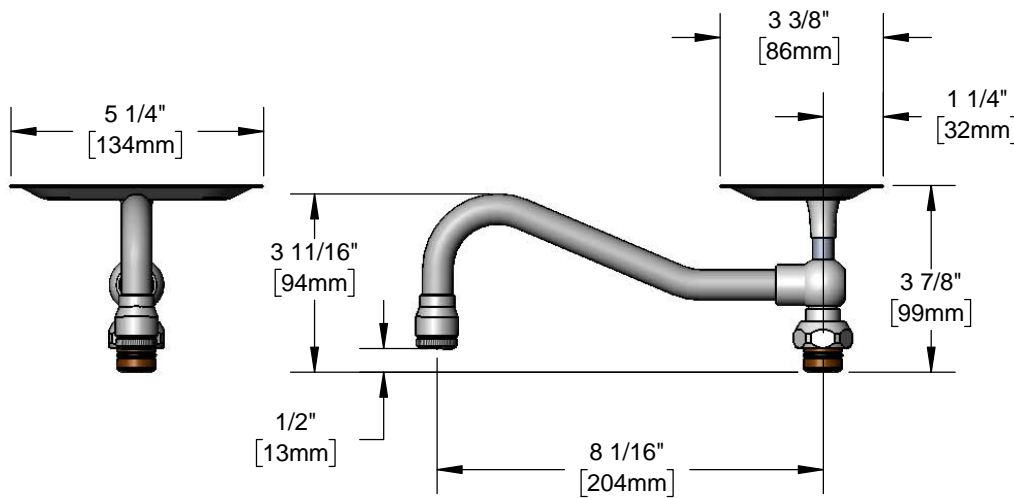

Architect/Engineering Specifications:

8" swing nozzle with stream regulator outlet and soap dish. Certified to ASME A112.18.1/CSA B125.1, NSF 61-Section 9 and NSF 372. Meets ADA ANSI/ICC A117.1 requirements.

Job Name _____
 Model Specified _____ Quantity _____
 Variations Specified _____
 Date _____



Features & Benefits:

- 8" swing nozzle w/ soap dish
- Stream regulator outlet, Series 2
- Fits all T&S swivel outlet faucets
- Material: Chrome plated brass tubular spout and soap dish

Product Compliance:

- ASME A112.18.1 / CSA B125.1
- NSF 61 - Section 9
- NSF 372 (Low Lead Content)



Warranty: One Year (Limited)

Performance Data:

- Pressure: 20 - 125 psi
- Temperature: 40°F - 140°F
- Flow Rate: TBD GPM @ 60 psi

Optional Outlets (Series 2 / VR Series 7)

GPM	Aerated	Non-Aerated (Laminar)	VR Aerated	VR Non-Aerated (VR Laminar)
0.35	N/A	<input type="checkbox"/> B-0199-02-N035	N/A	<input type="checkbox"/> B-0199-07-N035
0.5	N/A	<input type="checkbox"/> B-0199-02-N05	N/A	<input type="checkbox"/> B-0199-07-N05
1.0	<input type="checkbox"/> B-0199-02-F10	N/A	<input type="checkbox"/> B-0199-07-F10	N/A
1.2	<input type="checkbox"/> B-0199-02-F12	N/A	<input type="checkbox"/> B-0199-07-F12	N/A
1.5	<input type="checkbox"/> B-0199-02-WS	N/A	<input type="checkbox"/> B-0199-07-WS	N/A
2.2	<input type="checkbox"/> B-0199-02	N/A	<input type="checkbox"/> B-0199-07	N/A

