

DECORATIVE - page 1

Decorative bath and kitchen items available in over sixteen special finishes. (see inside front cover for finish swatches)

A**FAUCETS AND BATH ACCESSORIES - page 29**

Contemporary and classic designed kitchen, bath, tub, and shower faucets along with replacement parts and bath accessories.

FAU**SPECIALTIES AND REPAIR - page 41**

Basic plumbing and repair needs, including tank trip levers, tub and diverter spouts, bath waste kits, plumbing connectors, gas connectors, and more.

B**MISC. PLUMBING SPECIALTIES - page 93**

Wide range of items from basic plumbing items such as water heater stands, access panels and compression couplings to water meter boxes and pipe insulation.

C**FITTINGS AND VALVES - page 133**

Brass fittings, nylon fittings, push on fittings, PEX fittings, ball valves and more.

D**COMMERCIAL / RESIDENTIAL PLASTICS - page 175**

Assembled coverall drains and cleanouts that have both plastic and metal spuds with a variety of different strainer and cover diameters and finishes. Residential plastics such as shower drains, roof drains and floor sinks.

E**CAST IRON - page 243**

Cast iron products such as closet flanges, drains, "Code Blue" drains, and cleanouts.

F**TOOLS - page 279**

Hand tools, plumbing tools, cutting tools, shovels, measuring tools, caulk, and chemicals.

G**GASKETS AND COUPLINGS - page 311**

Compression gaskets and no hub couplings.

H&I**TUBULAR - page 317**

Chrome plated, rough brass, PVC and ABS plastic tubular products as well as lav drains and pop-up assemblies.

T**PVC/DWV FITTINGS - page 339**

PVC/DWV fittings including couplings, adapters, elbows, p-traps and bushings.

**PVC
DWV****BLACK AND GALVANIZED MALLEABLES/PIPE NIPPLES - page 349**

Black and galvanized malleable fittings, pipe nipples, ready-cut pipe and merchant couplings.

BG**COPPER - page 361**

Wrot/ACR fittings, forged brass/cast brass pressure fittings, wrot DWV solder fittings, cast DWV solder fittings and cast brass flanges.

CF**TOILET SEATS - page 379**

Commercial, residential, hospitality, and multi-family dwelling toilet seats.

TS**CONTRACTOR SPECIALTIES AND MRO PRODUCTS - page 391**

Products typically needed on the jobsite, everyday items such as work lights, gloves, trash bags, extension cords, locksets, and so much more.

MRO**MERCHANDISING - page 409**

We have a wide range of merchandising displays to fit your needs. We have peg board, tilt bin, and free standing options available. 'Keep'Em at Your Counter'!TM - custom solutions available.

MER

JONES STEPHENS PARTNER PROMISE

Our goal is to provide operational excellence every day.

QUICK • CORRECT • COMPLETE



QUICK

UPS orders received before 2 PM ship SAME DAY!

LTL orders ship within 24 HOURS, and sometimes SAME DAY!

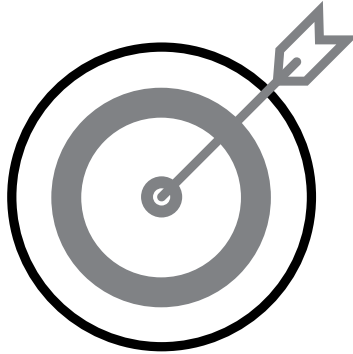

CORRECT

We pull and ship THOUSANDS of lines daily!

Our order accuracy is possible due to an extensive checking process.



COMPLETE

With over 18,000 SKUs across 14 categories, we have products on-hand to provide exactly what you need, when you need it! A complete order is always our goal!



WE GOT IT!

Your customer needs it quick, correct, and complete. We deliver what you need, when you need it!

We stay until we get the job done!



Your Go-To PROVIDER

At Jones Stephens, we want to make sure you can focus on what's most important - your customers. Leave the rest to us.

Let Jones Stephens be your **"go-to" provider** on all products on all product categories. The next time your primary source lets you down, think Jones Stephens.

Visit www.jonesstephens.com for more information.



You Need It...We Got It



CORE ITEMS

9 Specialty Categories • 1,300 Associated Items

You Need It.

With over 18,000 SKU's, we understand that shopping Jones Stephens' catalog can be a little perplexing. In fact, we've heard it over and over and we took it to heart! We simplified your selection by identifying 134 CORE items that Jones Stephens HAS that you absolutely NEED! **We didn't get rid of anything**; we just simplified the buying process for you! We identified the core items that you are more than likely already buying and listed the associated items for each.

They Want It.

Associated items are the every day items that not only you, but they (your customers) ask for. Here's an example: our C27150 – 1-½ Closet Spud is a core item which has 16 associated products. The associated list outlines other sizes and styles that maybe you didn't know Jones Stephens offers, but should have in stock.

We Got It.

You already buy these core products, but unless you're buying from Jones Stephens, you probably can't get them all from ONE company. Jones Stephens offers a consolidation advantage with all 134 core items being competitively priced. With no minimums, fast shipping and the best customer service around, we're determined to make your customer experience with Jones Stephens a great one!

Save Time. Save Money. Save Freight.

We Got It – Call Jones Stephens.

You Need It items are designated with our logo “” throughout this catalog.

DECORATIVE

Decorative Kitchen 3-5
Decorative Bathroom 6-28

*Published March 2017. List prices can be found in list price book and on our website.

Disposal Assembly



- Fits In-Sink-Erator
- Also acts as a basket strainer
- All stainless steel construction
- Positive stopper
- Clamshell or box package

PART NO.	BOX	FINISH	CTN/MSTR
B03004	B03004B	Almond	5/20
B03003	B03003B	Biscuit	5/20
B03005	B03005B	Flat Black	5/20
B03408	—	Brushed Nickel	5/20
B03401	—	Brushed Stainless	5/20
B03406	—	Oil Rubbed Bronze	5/20
B03407	—	Old World Bronze	5/20
B03001	B03001B	Polar White	5/20
B03405	—	Polished Nickel (PVD)	5/20
B03400	—	Polished Stainless	5/20

Basket Strainer



- Simple to install, operate and maintain
- Stainless steel flange and basket
- Positive seal
- Clamshell packaging

PART NO.	FINISH	CTN/MSTR
B02004	Almond	5/20
B02404	Antique Nickel	5/20
B02003	Biscuit	5/20
B02005	Black	5/20
B02408	Brushed Nickel	5/20
B02401	Brushed Stainless	5/20
B02406	Oil Rubbed Bronze	5/20
B02407	Old World Bronze	5/20
B02001	Polar White	5/20
B02405	Polished Nickel (PVD)	5/20
B02400	Polished Stainless	5/20

Replacement Basket Strainer



PART NO.	FINISH	FITS PART NO.	CTN/MSTR
B02304	Almond	B02004	10/40
B02303	Biscuit	B02003	10/40
B02305	Black	B02005	10/40
B0240BN	Brushed Nickel	B02408	10/40
B0240BS	Brushed Stainless	B02401	10/40
B0240RB	Oil Rubbed Bronze	B02406	10/40
B0240WB	Old World Bronze	B02407	10/40
B02301	Polar White	B02001	10/40
B0240PN	Polished Nickel	B02405	10/40
B0240PS	Polished Stainless	B02400	10/40

Items marked with the Jones Stephens logo are "You Need It... We Got It" Items.

Polished Brass Basket Strainer



- Metal construction

PART NO.	FINISH	CTN/MSTR
B02008	Polished Brass	1/50

ASAP Basket Strainer



- Ideal for quick installation
- Can be installed in less than one minute
- Brass slip nut
- Galvanized retaining ring and locking ring
- Durable stainless steel construction

PART NO.	FINISH	CTN/MSTR
S14009	Chrome Plated	1/24
S1409BN	Brushed Nickel	1/24

Disposal Assembly and Stopper



- Fits In-Sink-Erator
- Metal construction
- Matches well with S14 Duo Strainer Series

PART NO.	FINISH	CTN/MSTR
B03050	Polished Chrome	5/20
B0350BN	Brushed Nickel	5/20
B0350RB	Oil Rubbed Bronze	5/20
B0350WB	Old World Bronze	5/20
F05001	Polished Brass flange only	5/20
S45001	Polished Brass stopper only	5/20

Duo Strainer



- Cast brass

PART NO.	FINISH	CTN/MSTR
S14007	Chrome Plated	1/25
S1407BN	Brushed Nickel (PVD)	1/25
S1407RB	Oil Rubbed Bronze	1/25
S1407WB	Old World Bronze	1/25

A

Junior Duo Basket Strainer



- Complete with nuts and washers

PART NO.	FINISH	CTN/MSTR
B02050	Chrome Plated	1/100
B0250BN	Brushed Nickel	10/80
B0250RB	Oil Rubbed Bronze	10/80
B0250WB	Old World Bronze	10/80
B02100	Polished Brass	10/80

Deep Junior Duo Basket Strainer



- Polished brass body
- Complete with nuts and washers
- For 2" and 2-1/2" outlets

PART NO.	FINISH	CTN/MSTR
B02102	Chrome Plated	1/1
B02101	Polished Brass	1/1

Hose and Spray



- 1/4" universal coupling adapter
- Hose is white
- Blister card packaging

PART NO.	FINISH	CTN/MSTR
K52011	Biscuit	12/24
K52013	Black	12/24
K52014	Brushed Nickel	12/24
K52016	Oil Rubbed Bronze	12/24
K52017	Old World Bronze	12/24
K52010	Polar White	1/100

Bar Tap Faucet with Rotating Spout



- 9-1/2" high
- Can be used with reverse osmosis
- 1/4" to 3/8" O.D. adapter
- Handle can be installed side or front mount
- Spout rotates
- 5" reach

PART NO.	FINISH	CTN/MSTR
B70030	Chrome Plated	1/40
B70031	Brushed Nickel	1/40
B70032	Oil Rubbed Bronze	1/40
B70033	Old World Bronze	1/40
B70045	Threaded shank extension kit	1/200

Bar Tap Faucet



- 6-1/2" high
- Can be used with reverse osmosis
- All brass construction
- 1/2" connection
- Epoxy coated
- 1/4" inlet; 1-3/4" escutcheon
- Blister card packaging
- Lead Free

PART NO.	FINISH	CTN/MSTR
B45010	Chrome	1/36
B70009	Biscuit	6/36
B70003	Black	6/36
B70008	Brushed Nickel	6/36
B70007	Oil Rubbed Bronze	6/36
B70004	Old World Bronze	6/36
B70001	Polar White	6/36
B70006	Polished Brass	6/36

Lotion and Soap Dispenser with Brass Pump



- 2" spout
- All brass pump
- 7 ounce poly bottle
- Blister card packaging

PART NO.	FINISH	CTN/MSTR
S08020	Chrome	1/50
S10022	Biscuit	1/1
S10023	Black	1/1
S10025	Brushed Nickel (PVD)	1/1
S10024	Oil Rubbed Bronze	1/1
S10021	Polar White	1/1
S10020	Polished Brass	1/1

Faucet Hole Cover



- Wing nut included
- 1-3/4" diameter top

PART NO.	FINISH	MATERIAL	CTN/MSTR
B1020AL	Almond	Stainless Steel	12/250
B1020AB	Antique Brass	Brass	12/250
B1020AN	Antique Nickel	Brass	12/144
B1020BI	Biscuit	Stainless Steel	12/250
B1020BL	Black	Stainless Steel	12/144
B1020BN	Brushed Nickel (PVD)	Brass	12/144
B1020RB	Oil Rubbed Bronze	Brass	12/144
B1020WB	Old World Bronze	Brass	12/144
B1020PW	Polar White	Stainless Steel	12/250
B1020PN	Polished Nickel	Brass	12/250
B1020PS	Polished Stainless (PVD)	Brass	12/250

Celcon Faucet Hole Cover



- Molded Celcon- will not crack, chip or peel
- 1-3/4" diameter top
- Blister card packaging

PART NO.	FINISH	CTN/MSTR
C06011	Chrome	12/96
C06007	Almond	12/96
C06006	Biscuit	12/96
C06008	Black	12/96
C06014	Brushed Nickel	12/96
C06016	Oil Rubbed Bronze	12/96
C06013	Old World Bronze	12/96
C06004	Polar White	12/96
C06018	Polished Nickel (PVD)	12/96

Air Gap Cover



- Replaces chrome cover on most air gaps
- Blister card packaging

PART NO.	FINISH	CTN/MSTR
A10015	Chrome	1/1
A10004	Biscuit	1/1
A10018	Brushed Nickel	6/18
A10017	Oil Rubbed Bronze	6/72
A10019	Old World Bronze	6/72
A10002	Polar White	1/1

ABS Faucet Hole Cover



- Screw down type
- Fit all
- Made of ABS Plastic
- 1-3/4" diameter top; 3" length

PART NO.	FINISH	CTN/MSTR
C06002	Almond	1/1
C06001	Polar White	1/1

Brass Faucet Hole Cover



- Heavy duty brass construction
- 1-3/4" diameter top

PART NO.	FINISH	CTN/MSTR
C06021	Brushed Stainless	12/144
C06024	Polished Nickel	12/144
C06020	Polished Stainless	12/144

Air Gap



- Protects dishwasher from sewage backflow
- UPC listed

PART NO.	FINISH	CTN/MSTR
A10001	Chrome Plated	36/72
A10011	Polar White	1/50
A10010	Polished Brass	1/50

A

Lav Pop-Up Drain with Overflow



- For vessel sinks 1-1/2" drain hole
- 18 gauge
- With 4" drain body and 8" brass tailpiece
- Decorative finish covers all metal parts including tailpiece and lock nut
- Tailpiece opening - 1-1/4" OD

PART NO.	FINISH	CTN/MSTR
P35033	Chrome Plated	3/12
P3503BN	Brushed Nickel	3/12
P3503RB	Oil Rubbed Bronze	3/12
P3503WB	Old World Bronze	3/12

Lav Pop-Up Drain without Overflow



- For vessel sinks 1-1/2" drain hole
- 18 gauge
- With 4" drain body and 8" brass tailpiece
- Decorative finish covers all metal parts including tailpiece and lock nut
- Tailpiece opening - 1-1/4" OD

PART NO.	FINISH	CTN/MSTR
P35044	Chrome Plated	3/12
P3504BN	Brushed Nickel	3/12
P3504RB	Oil Rubbed Bronze	3/12
P3504WB	Old World Bronze	3/12

Lav Grid Drain without Overflow



- For vessel sinks 1-1/2" drain hole
- 18 gauge
- With 4" drain body and 8" brass tailpiece
- Decorative finish covers all metal parts including tailpiece and lock nut
- Tailpiece opening - 1-1/4" OD

PART NO.	FINISH	CTN/MSTR
D70205	Chrome Plated	3/12
D7020BN	Brushed Nickel	3/12
D7020RB	Oil Rubbed Bronze	3/12
D7020WB	Old World Bronze	3/12

Lav Grid Drain with Overflow



- For vessel sinks 1-1/2" drain hole
- 18 gauge
- With 4" drain body and 8" brass tailpiece
- Decorative finish covers all metal parts including tailpiece and lock nut
- Tailpiece opening - 1-1/4" OD

PART NO.	FINISH	CTN/MSTR
D70210	Chrome Plated	3/12
D7021BN	Brushed Nickel	3/12
D7021RB	Oil Rubbed Bronze	3/12
D7021WB	Old World Bronze	3/12

Lav Pop-Up Assembly with Overflow



- All metal construction
- Tool free locknut and ballrod nut
- 1-1/4" tubular
- 17 gauge
- Boxed

PART NO.	FINISH	CTN/MSTR
P35001	Chrome Plated (PVD)	1/25
P35002	Polished Brass (PVD)	1/10

Replacement Parts

PART NO.	DESCRIPTION	CTN/MSTR
P35920	Plunger	1/25
P35921	Flange	1/25
P35922	Lift Rod	1/25

Lav Lift and Turn Drain without Overflow



- For vessel sinks
- With 3" drain body and 4-3/4" brass tailpiece
- Tailpiece opening- 1-1/4" OD
- Blister card packaging

PART NO.	FINISH	CTN/MSTR
P35003	Chrome Plated	1/50
P3500BN	Brushed Nickel (PVD)	5/30
P3500RB	Oil Rubbed Bronze	5/30
P3500WB	Old World Bronze	5/30
P3500PB	Polished Brass	5/30

Lav Grid Drain without Overflow



- For vessel sinks
- With 2-1/4" drain body and 6" (5-7/8") brass tailpiece
- Tailpiece opening- 1-1/4" OD
- Blister card packaging

PART NO.	FINISH	CTN/MSTR
D70105	Chrome Plated	1/50
D7010BN	Brushed Nickel	1/25
D7010RB	Oil Rubbed Bronze	1/25
D7010WB	Old World Bronze	1/25
D7010PB	Polished Brass	1/25

Brass Tubular P-Trap



- 17 gauge
- Brass slip joint nut and rubber washers

PART NO.	FINISH	OD	CTN/MSTR
P3892BN	Brushed Nickel	1-1/4"	1/30
P3892RB	Oil Rubbed Bronze	1-1/4"	1/30
P3892WB	Old World Bronze	1-1/4"	1/30
P36125	Polished Brass	1-1/4"	1/30
P36150	Polished Brass	1-1/2"	1/30
P3892PB	Polished Brass (PVD)	1-1/4"	1/30

Brass Tubular P-Trap with Box Escutcheon



- 17 gauge
- Brass slip joint nut and rubber washers

PART NO.	FINISH	OD	CTN/MSTR
P3450CP	Chrome Plated	1-1/4"	1/1
P3450BN	Brushed Nickel	1-1/4"	1/1
P3450RB	Oil Rubbed Bronze	1-1/4"	1/1

Slip Joint Extension Tube



- 17 gauge
- Brass slip joint nut and rubber washers

PART NO.	FINISH	SIZE	CTN/MSTR
P3819BN	Brushed Nickel	1-1/4" x 8"	1/100
P3819RB	Oil Rubbed Bronze	1-1/4" x 8"	1/100

Offset Bath Supplies



- Chrome plated
- 1/2" supply tubes
- All hardware needed for connection included

PART NO.	DESCRIPTION	CTN/MSTR
B49020	Single offset (pair)	1/6
B49021	Double offset (pair)	1/6
B49022	Replacement nuts, washers and escutcheons	1/6

Polished Brass Shower Rod Flange with Set Screws



- Includes: two flanges, two set screws and four wood screws

PART NO.	FINISH	CTN/MSTR
S03152	Shower rod flange	1/1

Shower Diverter Valve



- Installs between arm and shower head
- Allows usage of hand-held shower or shower head
- Not a positive shut off

PART NO.	FINISH	CTN/MSTR
S01070	Chrome Plated	1/100
S01071	Brushed Nickel	1/100
S01072	Oil Rubbed Bronze	1/100
S01073	Old World Bronze	1/100

3" Adjustable Shower Head



- 2.5 GPM
- Solid Brass

PART NO.	FINISH	CTN/MSTR
S01010	Chrome Plated	1/20
S0101BN	Brushed Nickel	1/20
S0101RB	Oil Rubbed Bronze	1/20
S0101WB	Old World Bronze	1/20

Polished Brass Shower Head and Kit



- Shower head is solid brass with PVD finish
- Adjustable
- 2.5 GPM at 80 psi

PART NO.	DESCRIPTION	CTN/MSTR
S03009	2-1/4" face adjustable	1/50
S03051	Kit includes arm & flange w/set screws	1/1

Round Classic Shower Head



- 1/2" swivel connection
- 2.5 GPM at 80 PSI

5" Round			
PART NO.	FINISH	SIZE	CTN/MSTR
S01087	Chrome Plated	5"	1/20
S0187BN	Brushed Nickel	5"	1/20
S0187RB	Oil Rubbed Bronze	5"	1/20
S0187WB	Old World Bronze	5"	1/20
S01187	Polished Brass	5"	1/20

Round Shower Head with Metal Tips



- 1/2" swivel connection
- 2.5 GPM at 80 PSI
- Metal tips

6" Round			
PART NO.	FINISH	SIZE	CTN/MSTR
S01084	Chrome Plated	6"	1/10
S0184BN	Brushed Nickel (PVD)	6"	1/10
S0184RB	Oil Rubbed Bronze	6"	1/10
S0184WB	Old World Bronze	6"	1/10
S01184	Polished Brass (PVD)	6"	1/10

8" Round			
PART NO.	FINISH	SIZE	CTN/MSTR
S01085	Chrome Plated	8"	1/10
S0185BN	Brushed Nickel (PVD)	8"	1/10
S0185RB	Oil Rubbed Bronze	8"	1/10
S0185WB	Old World Bronze	8"	1/10
S01185	Polished Brass (PVD)	8"	1/10

10" Round			
PART NO.	FINISH	SIZE	CTN/MSTR
S01086	Chrome Plated	10"	1/6
S0186BN	Brushed Nickel (PVD)	10"	1/6
S0186RB	Oil Rubbed Bronze	10"	1/6
S0186WB	Old World Bronze	10"	1/6
S01186	Polished Brass (PVD)	10"	1/6

A Round Rain Style Shower Head with Dimples



- 1/2" swivel connection
- 2.5 GPM at 80 PSI

5" Round			
PART NO.	FINISH	SIZE	CTN/MSTR
S01088	Chrome Plated	5"	1/30
S0188BN	Brushed Nickel	5"	1/30
S0188RB	Oil Rubbed Bronze	5"	1/30
S0188WB	Old World Bronze	5"	1/30

8" Round			
PART NO.	FINISH	SIZE	CTN/MSTR
S01089	Chrome Plated	8"	1/15
S0189BN	Brushed Nickel	8"	1/15
S0189RB	Oil Rubbed Bronze	8"	1/15
S0189WB	Old World Bronze	8"	1/15

Round Shower Head with Gold Tips



- Chrome plated body with gold tips (removable)
- 2.5 GPM at 80 PSI

5" Round			
PART NO.	FINISH	SIZE	CTN/MSTR
S01090	Chrome Plated with gold tips	5"	1/20

9" Round			
PART NO.	FINISH	SIZE	CTN/MSTR
S01091	Chrome Plated with gold tips	9"	1/12

Shower Head with Rubber Tips



- 2.5 GPM at 80 PSI
- Chrome & Brushed Nickel finishes have grey tips
- Oil Rubbed Bronze & Old World Bronze finishes have black tips

10" Round			
PART NO.	FINISH	SIZE	CTN/MSTR
S01096	Chrome Plated	10"	1/6
S0196BN	Brushed Nickel	10"	1/6
S0196RB	Oil Rubbed Bronze	10"	1/6
S0196WB	Old World Bronze	10"	1/6



- 2.5 GPM at 80 PSI
- Chrome & Brushed Nickel finishes have grey tips
- Oil Rubbed Bronze & Old World Bronze finishes have black tips

8" Round			
PART NO.	FINISH	SIZE	CTN/MSTR
S01092	Chrome Plated	8"	1/15
S0192BN	Brushed Nickel	8"	1/15
S0192RB	Oil Rubbed Bronze	8"	1/15
S0192WB	Old World Bronze	8"	1/15

10" Round			
PART NO.	FINISH	SIZE	CTN/MSTR
S01093	Chrome Plated	10"	1/6
S0193BN	Brushed Nickel	10"	1/6
S0193RB	Oil Rubbed Bronze	10"	1/6
S0193WB	Old World Bronze	10"	1/6



- 2.5 GPM at 80 PSI
- Chrome & Brushed Nickel finishes have grey tips
- Oil Rubbed Bronze & Old World Bronze finishes have black tips

8" Square			
PART NO.	FINISH	SIZE	CTN/MSTR
S01094	Chrome Plated	8"	1/12
S0194BN	Brushed Nickel	8"	1/12
S0194RB	Oil Rubbed Bronze	8"	1/12
S0194WB	Old World Bronze	8"	1/12

10" Square			
PART NO.	FINISH	SIZE	CTN/MSTR
S01095	Chrome Plated	10"	1/8
S0195BN	Brushed Nickel	10"	1/8
S0195RB	Oil Rubbed Bronze	10"	1/8
S0195WB	Old World Bronze	10"	1/8

S-Shaped Shower Arm



- 18" length
- Adds 12" to height
- 1/2" female threads
- Fixed escutcheon

PART NO.	FINISH	SIZE	CTN/MSTR
S01055	Chrome Plated	1/2" x 18"	1/10
S0155BN	Brushed Nickel	1/2" x 18"	1/10
S0155RB	Oil Rubbed Bronze	1/2" x 18"	1/10
S0155WB	Old World Bronze	1/2" x 18"	1/10
S01155	Polished Brass (PVD)	1/2" x 18"	1/10

S-Shaped Shower Arm



- Chrome plated brass
- 8" or 10" length

PART NO.	FINISH	SIZE	CTN/MSTR
S01035	Chrome Plated	8"	1/80
S01038	Chrome Plated	10"	1/50

Ceiling Mount Shower Arm



- 1/2" female threads
- Fixed escutcheon

1/2" x 6"			
PART NO.	FINISH	SIZE	CTN/MSTR
S01051	Chrome Plated	1/2" x 6"	1/10
S0151BN	Brushed Nickel	1/2" x 6"	1/10
S0151RB	Oil Rubbed Bronze	1/2" x 6"	1/10
S0151WB	Old World Bronze	1/2" x 6"	1/10
S01151	Polished Brass (PVD)	1/2" x 6"	1/10
1/2" x 12"			
PART NO.	FINISH	SIZE	CTN/MSTR
S01052	Chrome Plated	1/2" x 12"	1/10
S0152BN	Brushed Nickel	1/2" x 12"	1/10
S0152RB	Oil Rubbed Bronze	1/2" x 12"	1/10
S0152WB	Old World Bronze	1/2" x 12"	1/10
S01152	Polished Brass (PVD)	1/2" x 12"	1/10
1/2" x 18"			
PART NO.	FINISH	SIZE	CTN/MSTR
S01053	Chrome Plated	1/2" x 18"	1/10
S0153BN	Brushed Nickel	1/2" x 18"	1/10
S0153RB	Oil Rubbed Bronze	1/2" x 18"	1/10
S0153WB	Old World Bronze	1/2" x 18"	1/10
S01153	Polished Brass (PVD)	1/2" x 18"	1/10

90° Shower Arm with Flange



- 18" length
- 1/2" female threads
- Fixed escutcheon

PART NO.	FINISH	SIZE	CTN/MSTR
S01056	Chrome Plated	1/2" x 18"	1/20
S0156BN	Brushed Nickel	1/2" x 18"	1/20
S0156RB	Oil Rubbed Bronze	1/2" x 18"	1/20
S0156WB	Old World Bronze	1/2" x 18"	1/20
S01156	Polished Brass	1/2" x 18"	1/20

Raised Bend Shower Arm



- 18" length
- 1/2" female threads
- Fixed escutcheon

PART NO.	FINISH	SIZE	CTN/MSTR
S01057	Chrome Plated	1/2" x 18"	1/20
S0157BN	Brushed Nickel	1/2" x 18"	1/20
S0157RB	Oil Rubbed Bronze	1/2" x 18"	1/20
S0157WB	Old World Bronze	1/2" x 18"	1/20
S01157	Polished Brass (PVD)	1/2" x 18"	1/20

Double Offset Shower Arm



- 18" length
- 1/2" female threads
- Adds 12" to height
- Fixed escutcheon

PART NO.	FINISH	SIZE	CTN/MSTR
S01058	Chrome Plated	1/2" x 18"	1/10
S0158BN	Brushed Nickel	1/2" x 18"	1/10
S0158RB	Oil Rubbed Bronze	1/2" x 18"	1/10
S0158WB	Old World Bronze	1/2" x 18"	1/10
S01158	Polished Brass (PVD)	1/2" x 18"	1/10

Shower Arm



- Fits E02 series escutcheons

6"			
PART NO.	FINISH	SIZE	CTN/MSTR
S01030	Chrome Plated	6"	1/200
S0130BN	Brushed Nickel	6"	1/200
S0130RB	Oil Rubbed Bronze	6"	1/200
S0130WB	Old World Bronze	6"	1/200
8"			
PART NO.	FINISH	SIZE	CTN/MSTR
S01032	Chrome Plated	8"	1/100
S0132BN	Brushed Nickel	8"	1/100
S0132RB	Oil Rubbed Bronze	8"	1/100
S0132WB	Old World Bronze	8"	1/100

Polished Brass Shower Arm



- Fits E81050 escutcheon

PART NO.	FINISH	SIZE	CTN/MSTR
S03030	Polished Brass	1/2" x 6"	20/200
S03032	Polished Brass	1/2" x 8"	20/200
S01036	Polished Brass	1/2" x 8" s-shaped	10/80
S01037	Polished Brass	1/2" x 10" s-shaped	10/60

Contoured Shower Curtain Rod

A

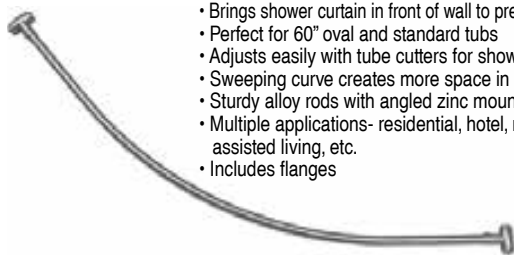

- Brings shower curtain in front of wall to prevent gaps and leaks
- Perfect for 60" oval and standard tubs
- Adjusts easily with tube cutters for shower walls
- Sweeping curve creates more space in center of tub
- Sturdy alloy rods with angled zinc mounting brackets
- Multiple applications- residential, hotel, motel, assisted living, etc.
- Includes flanges

PART NO.	FINISH	CTN/MSTR
S02190	Chrome Plated	1/12
S02193	Satin Nickel	1/6

Flanges

PART NO.	FINISH	CTN/MSTR
S02290	Chrome flanges (Fits S02190)	1/1
S02293	Satin Nickel flanges (Fits S02193)	1/1



- Easy installation
- Anchors included
- Brings shower curtain in front of wall to prevent gaps and leaks

PART NO.	FINISH	CTN/MSTR
S02197	Chrome Plated	1/1
S02198	Brushed Nickel	1/2

Cover Plates

- Mirrored acrylic
- Conceals damaged/cracked tiles
- Fits all standard bath/shower fittings
- No tools required-use silicone caulk
- DO NOT use abrasive cleaners



PART NO.	DESCRIPTION	SIZE	CTN/MSTR
T73001	Tub spout model	3-1/2" diameter	1/300
T73002	One handle model	8" x 14"	1/100
T73003	Two handle model	6" x 14"	1/40
T73004	Three handle model	6" x 14"	1/36

Polished Stainless Steel Repair Cover Plates

- 1, 2 or 3 hole design to fit multitude of valves
- Polished stainless steel finish
- Easily attaches with silicone caulk; 1-hole has brackets and screw
- 7-1/4" x 13" long



PART NO.	# OF HOLES	DIAMETER	CTN/MSTR
T73815	1	5-1/8"	1/40
T73816	2	1-3/8"	1/40
T73817	3	1-3/8"	1/40
T73818	1	3-3/4"	1/40

Polished Brass Shower Arm Flange



- Die cast with a set screw
- Poly bagged

PART NO.	DESCRIPTION	CTN/MSTR
S03040	1/2" with set screw	20/400

Polished Brass Tub Spouts



- 8-1/2"
- PVD durable finish
- All brass
- Boxed

PART NO.	DESCRIPTION	CONNECTION	CTN/MSTR
D03016	3/4" x 1/2" x 8-1/2"	Base	1/20



- Brass plated zamak
- Boxed

PART NO.	DESCRIPTION	CONNECTION	CTN/MSTR
D03020	1/2" FIP	Nose	1/50

Polished Brass Diverter Spouts



- Brass plated zamak
- Boxed

PART NO.	DESCRIPTION	CONNECTION	CTN/MSTR
D03001	1/2" FIP	Nose	1/50



- Brass plated zamak
- Boxed

PART NO.	DESCRIPTION	CONNECTION	CTN/MSTR
D03002	3/4" x 1/2" FIP	Base	1/50



- Brass plated zamak
- Boxed

PART NO.	DESCRIPTION	CONNECTION	CTN/MSTR
D03004	1/2" CTS (5/8" OD) Slip-on with hex key	Base	1/50



- Brass plated zamak
- Boxed

PART NO.	DESCRIPTION	CONNECTION	CTN/MSTR
D03010	3/4" x 1/2" FIP with 1/2" top connection for hand-held shower	Base	1/50



- Brass plated zamak
- Boxed

PART NO.	DESCRIPTION	CONNECTION	CTN/MSTR
D03011	3/4" x 1/2" FIP with 1/2" bottom connection for hand-held shower	Base	1/50



- 8-1/2"
- PVD durable finish
- All brass
- Boxed

PART NO.	DESCRIPTION	CONNECTION	CTN/MSTR
D03015	3/4" x 1/2" x 8-1/2" long	Base	1/20

Chrome Plated Diverter Spouts and Extensions



- Chrome plated brass
- 8-1/2" One piece diverter spout
- All brass
- Boxed

PART NO.	DESCRIPTION	CONNECTION	CTN/MSTR
D01015	3/4" x 1/2" FIP	Base	1/20

Extension Only



- Chrome plated brass

PART NO.	DESCRIPTION	CTN/MSTR
D01030	3" extension only	1/100
D01031	4-3/4" extension only	1/80



- Chrome plated Zamak
- Diverter spout for hand held shower

PART NO.	DESCRIPTION	CONNECTION	CTN/MSTR
D01010	3/4" x 1/2" FIP top connection	Base	1/10
D01011	3/4" x 1/2" MIP lower connection	Base	1/50

7" Chrome Plated Diverter Spout



- Chrome plated Zamak
- Longer length for today's larger tubs
- CTS unit comes with hex key

PART NO.	DESCRIPTION	CONNECTION	CTN/MSTR
D01024	1/2" FIP	Nose	1/50
D01025	1/2" CTS	Slide	1/25

Chrome Plated Diverter Spout with Polished Brass Knob



- Brass plated Zamak
- Boxed

PART NO.	DESCRIPTION	CONNECTION	CTN/MSTR
D01032	CP slip on diverter with PB knob	Base	1/50

7" Chrome Plated Tub Spout



- CTS unit comes with hex key
- Longer length for today's larger tubs
- Chrome plated Zamak

PART NO.	DESCRIPTION	CONNECTION	CTN/MSTR
D01026	1/2" FIP	Nose	1/50
D01027	1/2" CTS	Slide	1/25

Chrome Plated Tub Spouts



- Chrome plated Zamak
- CTS unit comes with hex key

PART NO.	DESCRIPTION	CONNECTION	CTN/MSTR
D01020	1/2" FIP	Nose	1/50
D01021	1/2" CTS	SlideBase	1/50



- Chrome plated brass
- 8-1/2" One piece diverter spout

PART NO.	DESCRIPTION	CONNECTION	CTN/MSTR
D01016	3/4" x 1/2" FIP	Base	1/20

9" Chrome Plated Tub and Diverter Spout



- Chrome plated brass
- One piece design
- 1/2" nose connection
- Solid brass construction

PART NO.	DESCRIPTION	CONNECTION	CTN/MSTR
D01017	1/2" FIP	Nose	1/12
D01018	1/2" FIP	Nose	1/12

Decorative Diverter Spout



- Zamak
- 1/2" CTS Slide connection

PART NO.	FINISH	CONNECTION	CTN/MSTR
D0104BN	Brushed Nickel	1/2" CTS Nose	1/50
D0104RB	Oil Rubbed Bronze	1/2" CTS Slide	1/50
D0104WB	Old World Bronze	1/2" CTS Slide	1/50

Ring for Tub Spouts and Diverter



- Adds decorative touch to any tub spout or diverter
- Fits between the wall and the tub spout or diverter
- 3-5/16" OD - 2-3/8" ID

PART NO.	FINISH	CTN/MSTR
D01050	Chrome Plated	1/200
D01050BN	Brushed Nickel	1/200
D01050RB	Oil Rubbed Bronze	1/200
D01050WB	Old World Bronze	1/200

A

Trip Lever with Spring



- Includes screws

PART NO.	FINISH	# OF HOLES	CTN/MSTR
T05003	Chrome Plated	2	25/200
T08003	Polished Brass	2	25/200
T08004	Polished Brass (PVD)	2	1/100

Overflow Plates



- Includes screws

PART NO.	FINISH	# OF HOLES	CTN/MSTR
T05012	Chrome Plated	1	25/200
T0812BN	Brushed Nickel	1	1/100
T0812RB	Oil Rubbed Bronze	1	1/100
T0812WB	Old World Bronze	1	1/100
T08012	Polished Brass (PVD)	1	1/200
T08013	Polished Brass	2	1/200
T08113	Polished Brass (PVD)	2	1/200
P35616	Satin Nickel	2	1/50

Polished Brass Lift and Turn Bath Waste Conversion Kit



- Converts regular bath waste to polished brass
- Fits 1-3/8" or 1-1/2" waste elbows
- Includes drain, bushing, faceplate, and 2 screws
- Blister card packaging

PART NO.	SIZE	# OF HOLES	CTN/MSTR
B51003	1/2" and 1-3/8"	2	1/12
B51020	1/2" and 1-3/8"	1	1/12

Lift and Turn Conversion Kit



- 1-hole faceplate
- 1-3/8" drain with bushing
- Includes drain, bushing, faceplate, aluminum adapter bar and screws
- Blister card packaging

PART NO.	FINISH	# OF HOLES	CTN/MSTR
B51019	Chrome Plated	1	1/36
B5160AP	Antique Pewter	1	1/36
B5160BB	Brushed Bronze	1	1/36
B5160BN	Brushed Nickel	1	1/36
B5160BS	Brushed Stainless	1	1/36
B5160RB	Oil Rubbed Bronze	1	1/36
B5160WB	Old World Bronze	1	1/36
B5160PN	Polished Nickel	1	1/36
B5160PS	Polished Stainless	1	1/36

Toe Touch Conversion Kit



- 1-hole faceplate
- 1-3/8" drain with bushing, screw, aluminum adapter bar, and faceplate
- Clamshell packaging

PART NO.	FINISH	# OF HOLES	CTN/MSTR
B51010	Chrome Plated	1	1/25
B5161AP	Antique Pewter	1	1/25
B5161BB	Brushed Bronze	1	1/25
B5161BN	Brushed Nickel	1	1/25
B5161RB	Oil Rubbed Bronze	1	1/25
B5161WB	Old World Bronze	1	1/25
B5161PS	Polished Stainless	1	1/25

Lift and Turn Conversion Kit



- 2-hole faceplate
- 1-3/8" drain with bushing, 2 screws and faceplate
- Clamshell packaging - B5155BNB and B5155WBB are boxed

PART NO.	FINISH	# OF HOLES	CTN/MSTR
B51005	Chrome Plated	2	1/25
B5155AL	Almond	2	1/25
B5155AB	Antique Brass	2	1/25
B5155AN	Antique Nickel	2	1/25
B5155AP	Antique Pewter	2	1/25
B5155BI	Biscuit	2	1/25
B5155BL	Black	2	1/25
B5155BB	Brushed Bronze	2	1/25
B5155BN	Brushed Nickel	2	1/25
B5155BS	Brushed Stainless	2	1/25
B5155RB	Oil Rubbed Bronze	2	1/25
B5155WB	Old World Bronze	2	1/25
B5155PW	Polar White	2	1/25
B5155PS	Polished Stainless	2	1/25
B51004	Satin Nickel	2	1/25
B5155BNB	Brushed Nickel (boxed)	2	1/25
B5155WBB	Old World Bronze (boxed)	2	1/25

Toe Touch Conversion Kit



- 2-hole faceplate
- Fits 1-3/8" or 1-1/2" waste elbows
- Includes drain, bushing, faceplate and 2 screws
- Clamshell packaging

PART NO.	FINISH	# OF HOLES	CTN/MSTR
B51007	Chrome Plated	2	1/25
B5156AP	Antique Pewter	2	1/25
B5156BB	Brushed Bronze	2	1/25
B5156BN	Brushed Nickel	2	1/25
B5156RB	Oil Rubbed Bronze	2	1/25
B5156WB	Old World Bronze	2	1/25
B5156PS	Polished Stainless	2	1/25

Items marked with the Jones Stephens logo are "You Need It... We Got It" Items.

Trip Lever Conversion Kit



- Fits 1-3/8" or 1-1/2" waste elbows
- Includes drain, bushing, faceplate and 2 screws
- Clamshell packaging

PART NO.	FINISH	# OF HOLES	CTN/MSTR
B51015	Chrome Plated	2	1/25
B5112AP	Antique Pewter	2	1/25
B5112BI	Biscuit	2	1/25
B5112BB	Brushed Bronze	2	1/25
B5112BN	Brushed Nickel	2	1/25
B5112BS	Brushed Stainless	2	1/25
B5112RB	Oil Rubbed Bronze	2	1/25
B5112WB	Old World Bronze	2	1/25
B5112PW	Polar White	2	1/25

Trip Lever Trim Only



- 2-hole faceplate
- Includes springs, faceplate, 2 screws and strainer
- Clamshell packaging

PART NO.	FINISH	# OF HOLES	CTN/MSTR
B51014	Chrome Plated	2	1/25
B5114AP	Antique Pewter	2	1/25
B5114BB	Brushed Bronze	2	1/25
B5114BN	Brushed Nickel	2	1/25
B5114RB	Oil Rubbed Bronze	2	1/25
B5114WB	Old World Bronze	2	1/25
B5114PB	Polished Brass	2	1/25
B5114PN	Polished Nickel	2	1/25
B5114PS	Polished Stainless	2	1/25

Trip Lever Faceplate and Handle



- Less screws

PART NO.	FINISH	# OF HOLES	CTN/MSTR
T05002	Chrome Plated	2	1/200
P3566AL	Almond	2	1/100
P3566AB	Antique Brass	2	1/100
P3566AN	Antique Nickel	2	1/100
P3566BI	Biscuit	2	1/100
P3566BL	Black	2	1/100
P3566BN	Brushed Nickel	2	1/100
P3566BS	Brushed Stainless	2	1/100
P3566RB	Oil Rubbed Bronze	2	1/100
P3566WB	Old World Bronze	2	1/100
P3566PW	Polar White	2	1/100
P3566PN	Polished Nickel	2	1/100
P3566PS	Polished Stainless	2	1/100

2-Hole Overflow Faceplate



- Includes screws

PART NO.	FINISH	# OF HOLES	CTN/MSTR
T05013	Chrome Plated	2	1/200
T0813BN	Brushed Nickel	2	1/1
T0813RB	Oil Rubbed Bronze	2	1/1
T0813WB	Old World Bronze	2	1/1
T0813PW	Polar White	2	1/1

Waste and Overflow Faceplate Only



- Less screws

PART NO.	FINISH	# OF HOLES	CTN/MSTR
T05011	Chrome Plated	2	1/200
P3565AL	Almond	2	1/50
P3565AB	Antique Brass	2	1/50
P3565AN	Antique Nickel	2	1/50
P3565BI	Biscuit	2	1/50
P3565BL	Black	2	1/50
P3565BN	Brushed Nickel	2	1/50
P3565BS	Brushed Stainless	2	1/50
P3565RB	Oil Rubbed Bronze	2	1/50
P3565WB	Old World Bronze	2	1/50
P3565PW	Polar White	2	1/50
P3565PN	Polished Nickel	2	1/50
P3565PS	Polished Stainless	2	1/50

Waste and Overflow Faceplate Screws



PART NO.	FINISH	SIZE	CTN/MSTR
T05021	Chrome Plated	1/4" x 2"	100/1000
T0521AL	Almond	1/4" x 2"	1/300
T0521AB	Antique Brass	1/4" x 2"	1/300
T0521AN	Antique Nickel	1/4" x 2"	1/300
T0521BI	Biscuit	1/4" x 2"	1/300
T0521BL	Black	1/4" x 2"	1/300
T0521BN	Brushed Nickel	1/4" x 2"	1/300
T0521BS	Brushed Stainless	1/4" x 2"	1/300
T0521RB	Oil Rubbed Bronze	1/4" x 2"	1/300
T0521WB	Old World Bronze	1/4" x 2"	1/300
T0521PW	Polar White	1/4" x 2"	1/300
T0521PN	Polished Nickel	1/4" x 2"	1/300
T0521PS	Polished Stainless	1/4" x 2"	1/300
T08021	Polished Brass	1/4" x 2"	50/2000
P35615	Satin Nickel	1/4" x 2"	1/25

A

Flip-It Conversion Kit



- No tools needed for installation
- Open or close with a flip of the toe
- Fits most popular tub drains (assorted o-ring included)
- One piece construction Delrin and ABS

PART NO.	FINISH	# OF HOLES	CTN/MSTR
P35170	Chrome Plated	1	1/5
P35172	Brushed Nickel	1	1/5
P35171	Polished Brass	1	1/5

Flip-It Bath Tub Stopper



- No tools needed for installation
- Open or close with a flip of the toe
- Fits most popular tub drains (assorted o-ring included)
- One piece construction Delrin and ABS

PART NO.	FINISH	CTN/MSTR
P35070	Chrome Plated	100/200
P35071	Polished Brass	1/100

Bath Drains



PART NO.	FINISH	DESCRIPTION	CTN/MSTR
P35061	Chrome Plated	1-3/8" Lift and Turn	1/100
P35051	Polished Brass	1-3/8" Lift and Turn	1/100
P35060	Chrome Plated	1-1/2" Lift and Turn	1/100
P35050	Polished Brass	1-1/2" Lift and Turn	1/100
P35065	White	1-1/2" Lift and Turn	1/100



PART NO.	FINISH	DESCRIPTION	CTN/MSTR
P35063	Chrome Plated	1-3/8" Toe Touch	1/100
P35062	Chrome Plated	1-1/2" Toe Touch	1/100
P35052	Polished Brass	1-1/2" Toe Touch	1/100



PART NO.	FINISH	DESCRIPTION	CTN/MSTR
P35056	Chrome Plated	5/16" Toe Touch Cartridge	1/300
P35055	Polished Brass	5/16" Toe Touch Cartridge	1/300



- 1-3/8" are fine threads
- 1-1/2" are coarse threads

PART NO.	DESCRIPTION	CTN/MSTR
T05024	1-3/8" female- 1-1/2" male bushing	50/300

Polished Brass/Satin Nickel Bath Drains



- PVD durable finish

PART NO.	FINISH	DESCRIPTION	CTN/MSTR
P35072	Polished Brass (PVD)	1-1/2" Lift and Turn	1/100
P35073	Polished Brass (PVD)	1-1/2" Toe Touch	1/50
P35068	Polished Brass (PVD)	1-1/2" Friction Lift	1/50
P35058	Polished Brass (PVD)	3/8" Toe Touch Replacement	1/100
P35610	Satin Nickel (PVD)	1-1/2" Lift and Turn	1/50
P35611	Satin Nickel (PVD)	1-1/2" Friction Lift	1/50
P35612	Satin Nickel (PVD)	1-1/2" Toe Touch	1/50
P35613	Satin Nickel (PVD)	1-1/2" Trip Lever	1/50
P35614	Satin Nickel (PVD)	1-1/2" Cable Drive	1/50

Toe Touch Bath Drain



- 1-1/2" drain
- Coarse thread

PART NO.	FINISH	CTN/MSTR
P35062	Chrome Plated	1/100
P3562AL	Almond	1/50
P3562AB	Antique Brass	1/50
P3562AN	Antique Nickel	1/50
P3562BI	Biscuit	1/50
P3562BL	Black	1/50
P3562BN	Brushed Nickel	1/50
P3562BS	Brushed Stainless	1/50
P3562RB	Oil Rubbed Bronze	1/50
P3562WB	Old World Bronze	1/50
P3562PW	Polar White	1/50
P3562PN	Polished Nickel	1/50
P3562PS	Polished Stainless	1/50

Trip Lever Body, Grid and Screw



- 1-1/2" drain
- Coarse thread

PART NO.	FINISH	CTN/MSTR
P35064	Chrome Plated	1/100
P3563AL	Almond	1/50
P3563AB	Antique Brass	1/50
P3563AN	Antique Nickel	1/50
P3563BI	Biscuit	1/50
P3563BL	Black	1/50
P3563BN	Brushed Nickel	1/50
P3563BS	Brushed Stainless	1/50
P3563RB	Oil Rubbed Bronze	1/50
P3563WB	Old World Bronze	1/50
P3563PW	Polar White	1/50
P3563PN	Polished Nickel	1/50
P3563PS	Polished Stainless	1/50

Lift and Turn Bath Drain



- Body and stopper
- 1-1/2" drain
- Coarse thread

PART NO.	FINISH	CTN/MSTR
P35066	Chrome Plated	1/100
P3560AL	Almond	1/50
P3560AB	Antique Brass	1/50
P3560AN	Antique Nickel	1/50
P3560BI	Biscuit	1/50
P3560BL	Black	1/50
P3560BN	Brushed Nickel	1/50
P3560BS	Brushed Stainless	1/50
P3560RB	Oil Rubbed Bronze	1/50
P3560WB	Old World Bronze	1/50
P3560PW	Polar White	1/50
P35050	Polished Brass	1/100
P3560PN	Polished Nickel	1/50
P3560PS	Polished Stainless	1/50
P35610	Satin Nickel	1/50

Friction Lift Bath Drain



- 1-1/2" drain
- Coarse thread

PART NO.	FINISH	CTN/MSTR
P35067	Chrome Plated	1/100
P3561AL	Almond	1/50
P3561AB	Antique Brass	1/50
P3561AN	Antique Nickel	1/50
P3561BI	Biscuit	1/50
P3561BL	Black	1/50
P3561BN	Brushed Nickel	1/50
P3561BS	Brushed Stainless	1/50
P3561RB	Oil Rubbed Bronze	1/50
P3561WB	Old World Bronze	1/50
P3561PW	Polar White	1/50
P35068	Polished Brass	1/50
P3561PN	Polished Nickel	1/50
P3561PS	Polished Stainless	1/50
P35611	Satin Nickel	1/50

Standard 1-Hole Schedule 40 Lift and Turn Bath Waste Kits

A



- 1-hole faceplate

Half Kit

PVC#	ABS#	FINISH	CTN/MSTR
B07010	B07011	Chrome Plated	1/1
B0750BN	B0850BN	Brushed Nickel	1/1
B0750RB	B0850RB	Oil Rubbed Bronze	1/1
B0750WB	B0850WB	Old World Bronze	1/1
B07014	B07015	Polished Brass	1/1



- 1-hole faceplate

Full Kit

PVC#	ABS#	FINISH	CTN/MSTR
B07030	B07031	Chrome Plated	1/1
B0751BN	B0851BN	Brushed Nickel	1/1
B0751RB	B0851RB	Oil Rubbed Bronze	1/1
B0751WB	B0851WB	Old World Bronze	1/1
B07034	B07035	Polished Brass	1/1

Standard 1-Hole Schedule 40 Friction Lift Bath Waste Kits



- 1-hole faceplate

Half Kit

PVC#	ABS#	FINISH	CTN/MSTR
B07052	B07053	Chrome Plated	1/1
B0752BN	B0852BN	Brushed Nickel	1/1
B0752RB	B0852RB	Oil Rubbed Bronze	1/1
B0752WB	B0852WB	Old World Bronze	1/1
B07054	B07055	Polished Brass	1/1



- 1-hole faceplate

Full Kit

PVC#	ABS#	FINISH	CTN/MSTR
B07058	B07059	Chrome Plated	1/1
B0753BN	B0853BN	Brushed Nickel	1/1
B0753RB	B0853RB	Oil Rubbed Bronze	1/1
B0753WB	B0853WB	Old World Bronze	1/1
B07060	B07061	Polished Brass	1/1

A Standard 1-Hole Schedule 40 Toe Touch Bath Waste Kits



• 1-hole faceplate

Half Kit			
PVC#	ABS#	FINISH	CTN/MSTR
B07012	B07013	Chrome Plated	1/24
B0754BN	B0854BN	Brushed Nickel	1/1
B0754RB	B0854RB	Oil Rubbed Bronze	1/1
B0754WB	B0854WB	Old World Bronze	1/1
B07016	—	Polished Brass	1/1



• 1-hole faceplate

Full Kit			
PVC#	ABS#	FINISH	CTN/MSTR
B07032	B07033	Chrome Plated	1/1
B0755BN	B0855BN	Brushed Nickel	1/1
B0755RB	B0855RB	Oil Rubbed Bronze	1/1
B0755WB	B0855WB	Old World Bronze	1/1
B0755NP	—	Pearl Nickel	1/1
B07036	B07037	Polished Brass	1/1

Standard 2-Hole Schedule 40 Lift and Turn Bath Waste Kits



• 2-hole faceplate

Half Kit			
PVC#	ABS#	FINISH	CTN/MSTR
B07110	B07111	Chrome Plated	1/1
B0711AL	B0811AL	Almond	1/1
B0711AB	B0811AB	Antique Brass	1/1
B0711AN	B0811AN	Antique Nickel	1/1
B0711BI	B0811BI	Biscuit	1/1
B0711BL	B0811BL	Black	1/1
B0711BN	B0811BN	Brushed Nickel	1/1
B0711BS	B0811BS	Brushed Stainless	1/1
B0711RB	B0811RB	Oil Rubbed Bronze	1/1
B0711WB	B0811WB	Old World Bronze	1/1
B0711PW	B0811PW	Polar White	1/1
B07114	B07115	Polished Brass	1/1
B0711PN	B0811PN	Polished Nickel	1/1
B0711PS	B0811PS	Polished Stainless	1/1



• 2-hole faceplate

Full Kit			
PVC#	ABS#	FINISH	CTN/MSTR
B07130	B07131	Chrome Plated	1/1
B0713AL	B0813AL	Almond	1/1
B0713AB	B0813AB	Antique Brass	1/1
B0713AN	B0813AN	Antique Nickel	1/1
B0713BI	B0813BI	Biscuit	1/1
B0713BL	B0813BL	Black	1/1
B0713BN	B0813BN	Brushed Nickel	1/1
B0713BS	—	Brushed Stainless	1/1
B0713RB	B0813RB	Oil Rubbed Bronze	1/1
B0713WB	B0813WB	Old World Bronze	1/1
B0713PW	B0813PW	Polar White	1/1
B07134	B07135	Polished Brass	1/1
B0713PN	B0813PN	Polished Nickel	1/1
B0713PS	B0813PS	Polished Stainless	1/1

Standard 2-Hole Schedule 40 Toe Touch Bath Waste Kits



• 2-hole faceplate

Half Kit			
PVC#	ABS#	FINISH	CTN/MSTR
B07112	B07113	Chrome Plated	1/1
B0717AL	B0817AL	Almond	1/1
B0717AB	B0817AB	Antique Brass	1/1
B0717AN	—	Antique Nickel	1/1
B0717BI	B0817BI	Biscuit	1/1
B0717BL	B0817BL	Black	1/1
B0717BN	B0817BN	Brushed Nickel	1/1
B0717BS	B0817BS	Brushed Stainless	1/1
B0717RB	B0817RB	Oil Rubbed Bronze	1/1
B0717WB	B0817WB	Old World Bronze	1/1
B0717PW	B0817PW	Polar White	1/1
B07116	B07117	Polished Brass	1/1
B0717PN	B0817PN	Polished Nickel	1/1
B0717PS	B0817PS	Polished Stainless	1/1



• 2-hole faceplate

Full Kit			
PVC#	ABS#	FINISH	CTN/MSTR
B07158	B07159	Chrome Plated	1/1
B0716AL	B0816AL	Almond	1/1
B0716AB	B0816AB	Antique Brass	1/1
B0716AN	B0816AN	Antique Nickel	1/1
B0716BI	B0816BI	Biscuit	1/1
B0716BL	B0816BL	Black	1/1
B0716BN	B0816BN	Brushed Nickel	1/1
B0716BS	B0816BS	Brushed Stainless	1/1
B0716RB	B0816RB	Oil Rubbed Bronze	1/1
B0716WB	B0816WB	Old World Bronze	1/1
B0716PW	B0816PW	Polar White	1/1
B07160	B07161	Polished Brass	1/1
B0716PN	B0816PN	Polished Nickel	1/1
B0716PS	B0816PS	Polished Stainless	1/1

Standard 2-Hole Schedule 40 Friction Lift Bath Waste Kits

A



• 2-hole faceplate

Half Kit			
PVC#	ABS#	FINISH	CTN/MSTR
B07152	B07153	Chrome Plated	1/1
B0715AL	B0815AL	Almond	1/1
B0715AB	B0815AB	Antique Brass	1/1
B0715AN	B0815AN	Antique Nickel	1/1
B0715BI	B0815BI	Biscuit	1/1
B0715BL	B0815BL	Black	1/1
B0715BN	B0815BN	Brushed Nickel	1/1
B0715BS	—	Brushed Stainless	1/1
B0715RB	B0815RB	Oil Rubbed Bronze	1/1
B0715WB	B0815WB	Old World Bronze	1/1
B0715PW	B0815PW	Polar White	1/1
B07154	B07155	Polished Brass	1/1
B0715PN	B0815PN	Polished Nickel	1/1
B0715PS	B0815PS	Polished Stainless	1/1



• 2-hole faceplate

Full Kit			
PVC#	ABS#	FINISH	CTN/MSTR
B07132	B07133	Chrome Plated	1/1
B0718AL	B0818AL	Almond	1/1
B0718AB	B0818AB	Antique Brass	1/1
B0718AN	B0818AN	Antique Nickel	1/1
B0718BI	B0818BI	Biscuit	1/1
B0718BL	B0818BL	Black	1/1
B0718BN	B0818BN	Brushed Nickel	1/1
B0718BS	B0817BS	Brushed Stainless	1/1
B0718RB	B0818RB	Oil Rubbed Bronze	1/1
B0718WB	B0818WB	Old World Bronze	1/1
B0718PW	B0818PW	Polar White	1/1
B07136	B07137	Polished Brass	1/1
B0718PN	B0818PN	Polished Nickel	1/1
B0718PS	B0818PS	Polished Stainless	1/1

Tubular Lift and Turn Bath Waste Kits

A



• 2-hole faceplate

Full Kit			
PVC#	ABS#	FINISH	CTN/MSTR
P37500	P39500	Chrome Plated	1/20
P3750AL	P3950AL	Almond	1/1
P3750AB	P3950AB	Antique Brass	1/1
P3750AN	P3950AN	Antique Nickel	1/1
P3750BI	P3950BI	Biscuit	1/1
P3750BL	P3950BL	Black	1/1
P3750BN	P3950BN	Brushed Nickel	1/1
P3750BS	P3950BS	Brushed Stainless	1/1
P3750RB	P3950RB	Oil Rubbed Bronze	1/1
P3750WB	P3950WB	Old World Bronze	1/1
P3750PW	P3950PW	Polar White	1/1
P3750PN	P3950PN	Polished Nickel	1/1
P3750PS	P3950PS	Polished Stainless	1/1
P37502	P39502	Satin Nickel	1/20

Tubular Toe Touch Bath Waste Kits



• 2-hole faceplate

Full Kit			
PVC#	ABS#	FINISH	CTN/MSTR
P37506	P39506	Chrome Plated	1/20
P3752AL	P3952AL	Almond	1/1
P3752AB	P3952AB	Antique Brass	1/1
P3752AN	P3952AN	Antique Nickel	1/1
P3752BI	P3952BI	Biscuit	1/1
P3752BL	P3952BL	Black	1/1
P3752BN	P3952BN	Brushed Nickel	1/1
P3752RB	P3952RB	Oil Rubbed Bronze	1/1
P3752WB	P3952WB	Old World Bronze	1/1
P3752PW	P3952PW	Polar White	1/1
P3752PN	P3952PN	Polished Nickel	1/1
P3752PS	P3952PS	Polished Stainless	1/1
P37508	P39508	Satin Nickel	1/20

Tubular Friction Lift Bath Waste Kits



• 2-hole faceplate

Full Kit			
PVC#	ABS#	FINISH	CTN/MSTR
P37503	P39503	Chrome Plated	1/20
P3751AL	P3951AL	Almond	1/1
P3751AB	P3951AB	Antique Brass	1/1
P3751AN	P3951AN	Antique Nickel	1/1
P3751BI	P3951BI	Biscuit	1/1
P3751BL	P3951BL	Black	1/1
P3751BN	P3951BN	Brushed Nickel	1/1
P3751BS	P3951BS	Brushed Stainless	1/1
P3751RB	P3951RB	Oil Rubbed Bronze	1/1
P3751WB	P3951WB	Old World Bronze	1/1
P3751PW	P3951PW	Polar White	1/1
P3751PN	P3951PN	Polished Nickel	1/1
P3751PS	P3951PS	Polished Stainless	1/1
P37505	P39505	Satin Nickel	1/20

Tubular Trip Lever Bath Waste Kits



• 2-hole faceplate

Full Kit			
PVC#	ABS#	FINISH	CTN/MSTR
P37509	P39509	Chrome Plated	1/20
P3761AL	P3961AL	Almond	1/1
P3761AB	P3961AB	Antique Brass	1/1
P3761AN	P3961AN	Antique Nickel	1/1
P3761BI	P3961BI	Biscuit	1/1
P3761BL	P3961BL	Black	1/1
P3761BN	P3961BN	Brushed Nickel	1/1
P3761BS	—	Brushed Stainless	1/1
P3761RB	P3961RB	Oil Rubbed Bronze	1/1
P3761WB	P3961WB	Old World Bronze	1/1
P3761PW	P3961PW	Polar White	1/1
P3761PN	P3961PN	Polished Nickel	1/1
P3761PS	P3961PS	Polished Stainless	1/1
P37511	P39511	Satin Nickel	1/20

27" Cable Drive Bath Waste Kits



- 1-1/2" Schedule 40 Cable Drive

Full Kit		
PVC#	FINISH	CTN/MSTR
P37550	Chrome Plated	1/10
P3755BN	Brushed Nickel	1/10
P3755RB	Oil Rubbed Bronze	1/10
P3755WB	Old World Bronze	1/10
P3755PB	Polished Brass	1/10
P3755WH	White	1/10

2" Metal Spud with 4-1/4" Round Strainer



- All brass spud & strainer
- Works with shower drain base D50001

PART NO.	FINISH	CTN/MSTR
D60981	Chrome Plated	1/50
D6098BN	Brushed Nickel	1/50
D6098RB	Oil Rubbed Bronze	1/50
D6098WB	Old World Bronze	1/50
D60982	Polished Brass	1/50
D60980	Stainless Steel	1/50

3-1/2" Metal Spud with 5" Square Strainer



- All brass spud & strainer
- Works with shower drain base D49804/D49801

PART NO.	FINISH	CTN/MSTR
D60954	Chrome Plated	1/20
D6096BN	Brushed Nickel	1/20
D60962	Nickel Bronze	1/20
D6096RB	Oil Rubbed Bronze	1/20
D6096WB	Old World Bronze	1/20
D60960	Polished Brass	1/20

2" Brass Spud with 4" Square Strainer



- All brass spud & strainer
- Grout ring
- Works with shower drain base D50001

PART NO.	FINISH	CTN/MSTR
D60942	Chrome Plated	1/27
D6094BN	Brushed Nickel	1/27
D6094RB	Oil Rubbed Bronze	1/27
D6094WB	Old World Bronze	1/27
D6094PB	Polished Brass	1/27

2" PVC Spud with 4-1/4" Stamped Square Strainer



PART NO.	FINISH	CTN/MSTR
D5087BN	Brushed Nickel	1/1
D5087RB	Oil Rubbed Bronze	1/1
D5087WB	Old World Bronze	1/1
D50887	Stainless Steel	1/1

2" x 3" Shower Drain with 2" Brass Spud and 4-1/4" Square Strainer



- All brass spud and strainer
- Grout ring

MADE IN THE
USA

PART NO.	FINISH	CTN/MSTR
D50942	Chrome Plated	1/1
D5094BN	Brushed Nickel	1/1
D5094RB	Oil Rubbed Bronze	1/1
D5094WB	Old World Bronze	1/1

A

2" x 3" Shower Drain with 2" Spud and 4" Square Snap-in Strainer



- No screws
- Four prong installation
- Plastic spud

MADE IN THE USA

PART NO.	FINISH	CTN/MSTR
D5088BN	Brushed Nickel	1/1
D5088RB	Oil Rubbed Bronze	1/1
D5088WB	Old World Bronze	1/1
D50888	Stainless Steel	1/1

2" x 3" Shower Drain with 2" Spud and 4-1/4" Round Strainer



- Flow rate - 3.102 GPM
- Metal Spud

MADE IN THE USA

PART NO.	FINISH	CTN/MSTR
D50111	Chrome Plated (cast brass)	1/1
D5001BN	Brushed Nickel (cast brass)	1/1
D5001RB	Oil Rubbed Bronze (cast brass)	1/1
D5001WB	Old World Bronze (cast brass)	1/1

2" x 3" Heavy Duty PVC Shower Drain with 3-1/2" Spud and 5" Round Cast Brass Strainer



- PVC spud
- Round strainer
- For multi-head showers
- Flow rate - 15.260 GPM
- Primer tapped

MADE IN THE USA

PART NO.	FINISH	CTN/MSTR
D49059	Chrome Plated	1/1
D4912BN	Brushed Nickel	1/1
D49057	Nickel Bronze	1/1
D4912RB	Oil Rubbed Bronze	1/1
D4912WB	Old World Bronze	1/1
D49055	Polished Brass	1/1

3" x 4" Heavy Duty PVC Shower Drain with 3-1/2" Spud and 5" Round Strainer



- Metal spud
- Round strainer
- For multi-head showers
- Flow rate - 15.260 GPM
- Primer tapped

MADE IN THE USA

PART NO.	FINISH	CTN/MSTR
D49159	Chrome Plated	1/1
D4991BN	Brushed Nickel	1/1
D49157	Nickel Bronze	1/1
D4991RB	Oil Rubbed Bronze	1/1
D4991WB	Old World Bronze	1/1
D49155	Polished Brass	1/1

3" x 4" Heavy Duty PVC Shower Drain with 3-1/2" Spud and 5" Square Strainer



- Metal spud
- Square strainer
- For multi-head showers
- Flow rate - 15.260 GPM
- Primer tapped

MADE IN THE USA

PART NO.	FINISH	CTN/MSTR
D4996BN	Brushed Nickel	1/1
D4996RB	Oil Rubbed Bronze	1/1
D4996WB	Old World Bronze	1/1

3" x 4" Heavy Duty PVC Shower Drain with 3-1/2" Plastic Spud and 5" Round Cast Brass Strainer



- PVC spud
- Round strainer
- For multi-head showers
- Flow rate - 15.260 GPM
- Primer tapped

MADE IN THE USA

PART NO.	FINISH	CTN/MSTR
D4984BN	Brushed Nickel	1/1
D4984RB	Oil Rubbed Bronze	1/1
D4984WB	Old World Bronze	1/1

2" No Caulk Shower Stall Drain with 4-1/4" Round Snap-in Strainer



- Wrench included
- For 2" CTS order gasket separately

PART NO.	FINISH	CTN/MSTR
D4010BN	Brushed Nickel	1/1
D4010RB	Oil Rubbed Bronze	1/1
D4010WB	Old World Bronze	1/1

4-1/4" Round Stamped Strainer



- Includes screws
- Fits D50001 tile shower drain
- Blister packaging
- Center to center screwholes- 3-3/8"

PART NO.	FINISH	CTN/MSTR
C60806	Chrome Plated	1/100
C6089AL	Almond	20/400
C6089AB	Antique Brass	20/400
C6089AN	Antique Nickel	20/400
C6089BI	Biscuit	20/400
C6089BL	Black	20/400
C6089BN	Brushed Nickel	20/200
C6089RB	Oil Rubbed Bronze	20/200
C6089WB	Old World Bronze	20/200
C6089PW	Polar White	20/400
C60810	Polished Brass (PVD)	20/400
C6089PN	Polished Nickel	20/400
C6089PS	Polished Stainless	20/200
C60814	Satin Nickel	1/100

4-1/4" Round Snap-in Strainer



- For no caulk fiberglass shower stalls
- Fits D40101, D40140 and D50001
- Snap-in prong to snap-in prong - 3"
- Blister packaging

PART NO.	FINISH	CTN/MSTR
D4005BN	Brushed Nickel	20/200
D4005RB	Oil Rubbed Bronze	1/200
D4005WB	Old World Bronze	1/200
D40003	Polished Brass (PVD)	50/250
D40010	Satin Nickel	20/200
D40005	Stainless Steel	1/200
D40004	White	50/200

4-1/4" Square Snap-in Strainer



- Fits D5088 series drains
- Stamped
- Coverall

PART NO.	FINISH	CTN/MSTR
C60888	Chrome Plated	1/100
C6088BN	Brushed Nickel	10/100
C6088RB	Oil Rubbed Bronze	10/100
C6088WB	Old World Bronze	10/100

4-1/4" Round Cast Brass Heavy Duty Strainer



- Includes screws
- Fits D50001 tile shower drain
- Center to center screwholes- 3-3/8"

PART NO.	FINISH	CTN/MSTR
C6087BN	Brushed Nickel	1/100
C6087RB	Oil Rubbed Bronze	1/100
C6087WB	Old World Bronze	1/100
C60807	Polished Brass (PVD)	1/100

4-1/4" Square Cast Brass Heavy Duty Strainer

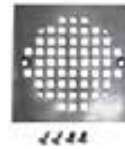

- Includes fine and coarse threaded screws
- Fits D50001 tile shower drain
- Center to center screwholes- 3-3/8"

PART NO.	FINISH	CTN/MSTR
C6083BN	Brushed Nickel	1/100
C6083RB	Oil Rubbed Bronze	1/100
C6083WB	Old World Bronze	1/100
C60813	Polished Brass (PVD)	1/100

5.196" Round Cast Brass Heavy Duty Strainer



- Includes screws
- Fits any drain with 3-1/2" PVC spud
- Center to center screwholes- 4-3/8"

PART NO.	FINISH	CTN/MSTR
C60803	Chrome Plated	1/50
C6084BN	Brushed Nickel	1/30
C6084RB	Oil Rubbed Bronze	1/30
C6084WB	Old World Bronze	1/30
C60804	Polished Brass	1/50

"Code Blue" Round Replacement Strainer

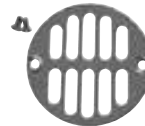

- Includes screws
- Fits non-adjustable "Code Blue" drains

PART NO.	DESCRIPTION	CTN/MSTR
D64000	2" SS	1/50
D64401	SS Crown	1/100
D64001	2" PB (PVD)	1/100
D6400BN	Brushed Nickel	1/250
D6400RB	Oil Rubbed Bronze	1/250
D6400WB	Old World Bronze	1/250

A

4" Round Strainer



- Includes screws
- Stamped to fit inside plastic ring
- Center to center screwholes- 3.362"

PART NO.	FINISH	CTN/MSTR
D54010	Polished Brass (PVD)	1/400

4-1/4" Round Strainer with Screws for Fiberglass Shower Stalls



- Fits D41001 and D41600
- Tapping screws included
- Center to center screwholes- 2-5/8"
- Blister card packaging

PART NO.	FINISH	CTN/MSTR
D4110BN	Brushed Nickel	20/200
D4110RB	Oil Rubbed Bronze	20/200
D4110WB	Old World Bronze	20/200
D4110PN	Polished Nickel	20/200
D41102	Polished Brass (PVD)	50/250
D41107	Satin Nickel	50/250
D41101	Stainless Steel	50/250

3-1/2" PVC Spud with 5" Round Strainer



- Fits drain bases tapped for 3-1/2" spuds

PART NO.	FINISH	CTN/MSTR
D56216	Chrome Plated	1/1
D6084BN	Brushed Nickel	1/1
D56214	Nickel Bronze	1/1
D6084RB	Oil Rubbed Bronze	1/1
D6084WB	Old World Bronze	1/1
D56212	Polished Brass	1/1
D56211	Stainless Steel	1/1

3-1/2" Metal Spud with 5" Round Strainer



- All brass
- Fits drain bases tapped for 3-1/2" spuds

PART NO.	FINISH	CTN/MSTR
D60990	Chrome Plated	1/40
D6091BN	Brushed Nickel	1/40
D60996	Nickel Bronze	1/30
D6091RB	Oil Rubbed Bronze	1/40
D6091WB	Old World Bronze	1/40
D60991	Polished Brass	1/40

Escutcheons



Low Pattern - Copper Tube Size

PART NO.	FINISH	SIZE	FLANGE OD	CTN/MSTR
E0105BN	Brushed Nickel	1/2" CTS (5/8" OD)	2-1/2"	1/200
E0105RB	Oil Rubbed Bronze	1/2" CTS (5/8" OD)	2-1/2"	1/200
E0105WB	Old World Bronze	1/2" CTS (5/8" OD)	2-1/2"	1/200

Low Pattern - Iron Pipe Size

PART NO.	FINISH	SIZE	FLANGE OD	CTN/MSTR
E0205BN	Brushed Nickel	1/2" IPS	2-1/2"	1/300
E0205RB	Oil Rubbed Bronze	1/2" IPS	2-1/2"	1/300
E0205WB	Old World Bronze	1/2" IPS	2-1/2"	1/300

Box Pattern - Tubular

PART NO.	FINISH	SIZE	FLANGE OD	CTN/MSTR
E0412BN	Brushed Nickel	1-1/4" Tubular	3"	1/100
E0412RB	Oil Rubbed Bronze	1-1/4" Tubular	3"	1/100
E0412WB	Old World Bronze	1-1/4" Tubular	3"	1/100
E0415BN	Brushed Nickel	1-1/2" Tubular	3"	1/100
E0415RB	Oil Rubbed Bronze	1-1/2" Tubular	3"	1/100
E0415WB	Old World Bronze	1-1/2" Tubular	3"	1/100

Bell Pattern - Copper Tube Size

PART NO.	FINISH	SIZE	FLANGE OD	CTN/MSTR
E0705BN	Brushed Nickel	1/2" CTS (5/8" OD)	2-3/8"	1/100
E0705RB	Oil Rubbed Bronze	1/2" CTS (5/8" OD)	2-3/8"	1/100
E0705WB	Old World Bronze	1/2" CTS (5/8" OD)	2-3/8"	1/100
E0705PB	Polished Brass	1/2" CTS (5/8" OD)	2-3/8"	1/100

Bell Pattern - Iron Pipe Size

PART NO.	FINISH	SIZE	FLANGE OD	CTN/MSTR
E0605BN	Brushed Nickel	1/2" IPS	2-3/8"	1/100
E0605RB	Oil Rubbed Bronze	1/2" IPS	2-3/8"	1/100
E0605WB	Old World Bronze	1/2" IPS	2-3/8"	1/100
E0605PB	Polished Brass	1/2" IPS	2-3/8"	1/100

Bell Pattern - Tubular

PART NO.	FINISH	SIZE	FLANGE OD	CTN/MSTR
E0812BN	Brushed Nickel	1-1/4" Tubular	3"	1/100
E0812RB	Oil Rubbed Bronze	1-1/4" Tubular	3"	1/100
E0812WB	Old World Bronze	1-1/4" Tubular	3"	1/100
E0812PB	Polished Brass	1-1/4" Tubular	3"	1/100
E0815BN	Brushed Nickel	1-1/2" Tubular	3"	1/100
E0815RB	Oil Rubbed Bronze	1-1/2" Tubular	3"	1/100
E0815WB	Old World Bronze	1-1/2" Tubular	3"	1/100
E0815PB	Polished Brass	1-1/2" Tubular	3"	1/100

Polished Brass Escutcheon



• Low Patten

PART NO.	DESCRIPTION	CTN/MSTR
E80050	1/2" CTS (5/8" OD)	500/1000
E80075	3/4" CTS (7/8" OD)	500/1000
E81375	3/8" IPS	500/1000
E81050	1/2" IPS	500/1000



• Box Patten

PART NO.	DESCRIPTION	CTN/MSTR
E82125	1-1/4" OD tubular	100/200
E82150	1-1/2" OD tubular	100/200

Polished Brass Finish Flexible Floor and Ceiling Plate



• Plastic

PART NO.	DESCRIPTION	CTN/MSTR
F08375	3/8" IPS or 1/2" CTS	12/1080
F08050	1/2" IPS or 3/4" CTS	12/1080
F08124	1-1/4" CTS	12/1440
F08150	1-1/2" IPS	12/1200

Non-Slotted Full Flow Aerator



• Dual threads (15/16 -27 male x 55/64 -27 female)

PART NO.	FINISH	CTN/MSTR
A01019	Polished Brass	1/500

Brass Nipple



• Lead Free

3/8" x 4"

PART NO.	FINISH	SIZE	CTN/MSTR
N2206BN	Brushed Nickel (PVD)	3/8" x 4"	25/200
N2206RB	Oil Rubbed Bronze	3/8" x 4"	25/200
N2206WB	Old World Bronze	3/8" x 4"	25/200
N17375	Polished Brass	3/8" x 4"	25/200

3/8" x 6"

PART NO.	FINISH	SIZE	CTN/MSTR
N2210BN	Brushed Nickel (PVD)	3/8" x 6"	25/100
N2210RB	Oil Rubbed Bronze	3/8" x 6"	25/100
N2210PB	Polished Brass	3/8" x 6"	25/100

1/2" x 4"

PART NO.	FINISH	SIZE	CTN/MSTR
N2306BN	Brushed Nickel (PVD)	1/2" x 4"	25/200
N2306RB	Oil Rubbed Bronze	1/2" x 4"	25/200
N2306WB	Old World Bronze	1/2" x 4"	25/200
N17050	Polished Brass	1/2" x 4"	25/200

1/2" x 6"

PART NO.	FINISH	SIZE	CTN/MSTR
N2310BN	Brushed Nickel (PVD)	1/2" x 6"	25/100
N2310RB	Oil Rubbed Bronze	1/2" x 6"	25/100
N2310WB	Old World Bronze	1/2" x 6"	25/100
N2310PB	Polished Brass	1/2" x 6"	25/100

Sleeves



• Fits over 1/2" CTS
• Brass

PART NO.	FINISH	SIZE	CTN/MSTR
T73300	Chrome	1/2" x 3-1/2"	1/200
T7330BN	Brushed Nickel (PVD)	1/2" x 3-1/2"	1/200
T7330RB	Oil Rubbed Bronze	1/2" x 3-1/2"	1/200
T7330WB	Old World Bronze	1/2" x 3-1/2"	1/200
T7330PB	Polished Brass (PVD)	1/2" x 3-1/2"	1/200

Quarter Turn Angle Stop with 5" Sweat Extension and Escutcheon



• Bell escutcheon
• 3/8" OD x 1/2" sweat connection
• Includes hot, cold and blank buttons

PART NO.	FINISH	CTN/MSTR
S42220	Chrome Plated	1/50
S4222BN	Brushed Nickel	1/50
S4222RB	Oil Rubbed Bronze	1/50
S4222WB	Old World Bronze	1/50

A

Quarter Turn Angle Stop



- Cross handle
- Includes hot, cold and blank buttons
- UPC Listed



1/2" FIP x 3/8" OD

PART NO.	FINISH	SIZE	CTN/MSTR
S42021	Chrome Plated	1/2" FIP x 3/8" OD	20/100
S4202BN	Brushed Nickel	1/2" FIP x 3/8" OD	20/100
S4202RB	Oil Rubbed Bronze	1/2" FIP x 3/8" OD	20/100
S4202WB	Old World Bronze	1/2" FIP x 3/8" OD	20/100
S4202PB	Polished Brass (PVD)	1/2" FIP x 3/8" OD	20/100

5/8" OD x 3/8" OD

PART NO.	FINISH	SIZE	CTN/MSTR
S42031	Chrome Plated	5/8" OD x 3/8" OD	20/100
S4203BN	Brushed Nickel	5/8" OD x 3/8" OD	20/100
S4203RB	Oil Rubbed Bronze	5/8" OD x 3/8" OD	20/100
S4203WB	Old World Bronze	5/8" OD x 3/8" OD	20/100
S4203PB	Polished Brass	5/8" OD x 3/8" OD	20/100



- Oval handle
- UPC Listed



3/8" OD x 3/8" OD

PART NO.	FINISH	SIZE	CTN/MSTR
S4212BN	Brushed Nickel	3/8" OD x 3/8" OD	20/100
S4212RB	Oil Rubbed Bronze	3/8" OD x 3/8" OD	20/100
S4212WB	Old World Bronze	3/8" OD x 3/8" OD	20/100

Quarter Turn Straight Stop



- Cross handle
- Includes hot, cold and blank buttons
- UPC Listed



1/2" FIP x 3/8" OD

PART NO.	FINISH	SIZE	CTN/MSTR
S43021	Chrome Plated	1/2" FIP x 3/8" OD	20/100
S4302BN	Brushed Nickel	1/2" FIP x 3/8" OD	20/100
S4302RB	Oil Rubbed Bronze	1/2" FIP x 3/8" OD	20/100
S4302WB	Old World Bronze	1/2" FIP x 3/8" OD	20/100
S4302PB	Polished Brass (PVD)	1/2" FIP x 3/8" OD	20/100

5/8" OD x 3/8" OD

PART NO.	FINISH	SIZE	CTN/MSTR
S43031	Chrome Plated	5/8" OD x 3/8" OD	20/100
S4303BN	Brushed Nickel	5/8" OD x 3/8" OD	20/100
S4303RB	Oil Rubbed Bronze	5/8" OD x 3/8" OD	20/100
S4303WB	Old World Bronze	5/8" OD x 3/8" OD	20/100
S4303PB	Polished Brass (PVD)	5/8" OD x 3/8" OD	20/100



- Oval handle
- UPC Listed



3/8" FIP x 3/8" OD

PART NO.	FINISH	SIZE	CTN/MSTR
S4311BN	Brushed Nickel	3/8" FIP x 3/8" OD	20/100
S4311RB	Oil Rubbed Bronze	3/8" FIP x 3/8" OD	20/100
S4311WB	Old World Bronze	3/8" FIP x 3/8" OD	20/100

Multi-Turn Compression Angle Stop



- UPC Listed



PART NO.	FINISH	SIZE	CTN/MSTR
S4211BN	Brushed Nickel	5/8" COMP x 3/8" COMP	20/100
S4211RB	Oil Rubbed Bronze	5/8" COMP x 3/8" COMP	20/100
S4211WB	Old World Bronze	5/8" COMP x 3/8" COMP	20/100
S4213BN	Brushed Nickel	1/2" FIP x 3/8" COMP	20/100
S4213RB	Oil Rubbed Bronze	1/2" FIP x 3/8" COMP	20/100
S4213WB	Old World Bronze	1/2" FIP x 3/8" COMP	20/100

Multi-Turn Compression Straight Stop



- UPC Listed



PART NO.	FINISH	SIZE	CTN/MSTR
S4312BN	Brushed Nickel	5/8" COMP x 3/8" COMP	20/100
S4312RB	Oil Rubbed Bronze	5/8" COMP x 3/8" COMP	20/100
S4312WB	Old World Bronze	5/8" COMP x 3/8" COMP	20/100
S4314BN	Brushed Nickel	1/2" FIP x 3/8" COMP	20/100
S4314RB	Oil Rubbed Bronze	1/2" FIP x 3/8" COMP	20/100
S4314WB	Old World Bronze	1/2" FIP x 3/8" COMP	20/100

Closest Supply and Stop Kit



- Supply and multi-turn stop
- 1/2" CTS escutcheon

3/8" x 20" Closet Supply and 3/8" x 5/8" Angle Stop Kit

PART NO.	FINISH	CTN/MSTR
S1037CP	Chrome	1/1
S1037AP	Antique Pewter	1/1
S1037BB	Brushed Bronze	1/1
S1037BN	Brushed Nickel	1/1
S1037RB	Oil Rubbed Bronze	1/1
S1037WB	Old World Bronze	1/1
S10371	Polished Brass	1/1
S1037PS	Polished Stainless	1/1

3/8" x 20" Closet Supply and 3/8" x 5/8" Straight Stop Kit

PART NO.	FINISH	CTN/MSTR
S1038CP	Chrome Plated	1/1
S1038AP	Antique Pewter	1/1
S1038BB	Brushed Bronze	1/1
S1038BN	Brushed Nickel	1/1
S1038RB	Oil Rubbed Bronze	1/1
S1038WB	Old World Bronze	1/1
S10381	Polished Brass	1/1
S1038PS	Polished Stainless	1/1

3/8" x 20" Closet Supply and 1/2" x 3/8" Angle Stop Kit

PART NO.	FINISH	CTN/MSTR
S1039CP	Chrome Plated	1/1
S1039BN	Brushed Nickel	1/1
S1039RB	Oil Rubbed Bronze	1/1

3/8" x 20" Closet Supply and 5/8" x 3/8" Angle Stop Kit

PART NO.	FINISH	CTN/MSTR
S1137BN	Brushed Nickel	1/1
S1137RB	Oil Rubbed Bronze	1/1

3/8" x 20" Closet Supply and 5/8" x 3/8" Straight Stop Kit

PART NO.	FINISH	CTN/MSTR
S1138BN	Brushed Nickel	1/1
S1138RB	Oil Rubbed Bronze	1/1

Lavatory Supply and Stop Kit

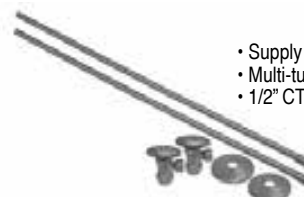

- Supply (2 pieces)
- Multi-turn stop (2 pieces)
- 1/2" CTS escutcheon (2 pieces)

3/8" x 20" Lavatory Supply and 3/8" x 5/8" Angle Stop Kit

PART NO.	FINISH	CTN/MSTR
S1036AP	Antique Pewter	1/25
S1036BN	Brushed Nickel	1/25
S1036RB	Oil Rubbed Bronze	1/25
S1036WB	Old World Bronze	1/25
S10361	Polished Brass	1/25

3/8" x 20" Lavatory Supply and 3/8" x 5/8" Straight Stop Kit

PART NO.	FINISH	CTN/MSTR
S1035AP	Antique Pewter	1/25
S1035BB	Brushed Bronze	1/25
S1035BN	Brushed Nickel	1/25
S1035RB	Oil Rubbed Bronze	1/25
S1035WB	Old World Bronze	1/25
S10351	Polished Brass	1/25
S1035PS	Polished Stainless	1/25

3/8" x 20" Lavatory Supply and 1/2" x 3/8" Angle Stop Kit

PART NO.	FINISH	CTN/MSTR
S1034BN	Brushed Nickel	1/1
S1034RB	Oil Rubbed Bronze	1/1

3/8" x 20" Lavatory Supply and 5/8" x 3/8" Angle Stop Kit

PART NO.	FINISH	CTN/MSTR
S1136BN	Brushed Nickel	1/1
S1136RB	Oil Rubbed Bronze	1/1

3/8" x 20" Lavatory Supply and 5/8" x 3/8" Straight Stop Kit

PART NO.	FINISH	CTN/MSTR
S1135BN	Brushed Nickel	1/1
S1135RB	Oil Rubbed Bronze	1/1

Polished Brass Water Supply Tubes



- Bullnose rigid supply tube

PART NO.	DESCRIPTION	CTN/MSTR
S44002	3/8" x 20" Basin Tube	1/100
S44003	3/8" x 12" Tank Tube	1/200
S44005	3/8" x 20" Tank Tube	1/100

Lavatory Supply Tubes

A



- Basin supply
- Bullnose rigid supply tube

3/8" x 12"

PART NO.	FINISH	SIZE	CTN/MSTR
S04020	Chrome Plated	3/8" x 12"	1/100
S4401BN	Brushed Nickel	3/8" x 12"	1/100
S4401RB	Oil Rubbed Bronze	3/8" x 12"	1/100
S4401WB	Old World Bronze	3/8" x 12"	1/100

3/8" x 20"

PART NO.	FINISH	SIZE	CTN/MSTR
S04022	Chrome Plated	3/8" x 20"	1/100
S4402BN	Brushed Nickel	3/8" x 20"	1/100
S4402RB	Oil Rubbed Bronze	3/8" x 20"	1/100
S4402WB	Old World Bronze	3/8" x 20"	1/100

Closet Supply Tubes

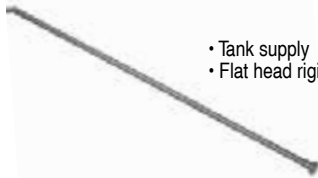

- Tank supply
- Flat head rigid supply tube

3/8" x 12"

PART NO.	FINISH	SIZE	CTN/MSTR
S04027	Chrome Plated	3/8" x 12"	1/100
S4403BN	Brushed Nickel	3/8" x 12"	1/100
S4403RB	Oil Rubbed Bronze	3/8" x 12"	1/100
S4403WB	Old World Bronze	3/8" x 12"	1/100

3/8 x 20"

PART NO.	FINISH	SIZE	CTN/MSTR
S04029	Chrome Plated	3/8" x 20"	1/100
S4405BN	Brushed Nickel	3/8" x 20"	1/100
S4405RB	Oil Rubbed Bronze	3/8" x 20"	1/100
S4405WB	Old World Bronze	3/8" x 20"	1/100

Ultrafit Tank Trip Lever - Replaces 96% of All Tank Levers



- PATENTED
- New shapable arm bends to fit the needed arm angle
- Arm can be cut to fit 4", 6" or 8" lengths for customized fit
- Heavy duty plastic handle comes in a variety of finishes
- Sturdy plastic arm, spud and nut
- Blister card packaging

PART NO.	FINISH	CTN/MSTR
T01100	Chrome Plated	1/200
T01101	Polished Brass	1/200
T01102	White	1/200
T01103	Bone	1/200
T04001	Display for UltraFit Tank levers 12 each of above	1/1

Tank Trip Levers



- Front mount
- 8" arm

PART NO.	DESCRIPTION	FINISH	CTN/MSTR
T01003	Brass arm with metal spud and nut	PB Metal	25/200
T01004	Brass plated arm with metal spud and nut	AB Metal	25/200
T01007	Brass arm with metal spud and nut	Satin Nickel	25/200



- Front mount
- 8" arm

PART NO.	DESCRIPTION	FINISH	CTN/MSTR
T01061	Brass plated arm with plastic spud and nut / universal fit	PB Metal	25/200



- Front mount
- 8" arm

PART NO.	DESCRIPTION	FINISH	CTN/MSTR
T01006	Brass arm with metal spud and nut / universal fit	PB Metal	25/200
T01008	Brass arm with die cast nut	Satin Nickel	25/200



- Side mount
- 8" arm

PART NO.	DESCRIPTION	FINISH	CTN/MSTR
T01071	Side mount push button brass arm with plastic spud and nut	PB ABS	25/50
T01075	Front mount push button brass arm with plastic spud and nut	PV ABS	25/50

Tank Trip Levers for American Standard*



• Front mount
• 9-1/2" arm

PART NO.	DESCRIPTION	FINISH	CTN/MSTR
T01065	Brass arm with metal spud and nut. Offset for thick walls	PB Metal	25/150



• Front mount
• 8" arm

PART NO.	DESCRIPTION	FINISH	CTN/MSTR
T01049	Neo 28° combo with plastic arm, spud and nut	PB ABS	1/25



• Front mount
• 6" arm

PART NO.	DESCRIPTION	FINISH	CTN/MSTR
T01043	45° arm for Cadet 2* plastic arm, spud and nut	PB ABS	1/25
T01044	45° arm with Cadet 2* plastic arm, spud and nut	White ABS	1/25
T01045	45° arm with Cadet 2* plastic arm, spud and nut	Bone ABS	1/25



• Front mount
• 4" arm

PART NO.	DESCRIPTION	FINISH	CTN/MSTR
T01031	Plastic arm, spud and nut for beaded chain	PB ABS	1/25
T01032	Plastic arm, spud and nut for beaded chain	White ABS	1/25
T01033	Plastic arm, spud and nut for beaded chain	Bone ABS	1/25



• Front mount
• 6" arm

PART NO.	DESCRIPTION	FINISH	CTN/MSTR
T01051	Plastic arm, spud and nut for Plebe* and Cadet*	PB ABS	1/25
T01052	Plastic arm, spud and nut for Plabe* and Cadet*	White ABS	1/25
T01053	Plastic arm, spud and nut or Pleve* and Cadet*	Bone ABS	1/25

* The manufacturers' names are used only to describe whose products the tank levers will fit. The tank levers are not manufactured by those companies.

Tank Trip Levers for Crane*



• Front mount
• 8" arm

PART NO.	DESCRIPTION	FINISH	CTN/MSTR
T01035	Plastic arm, spud and nut	PB ABS	1/25
T01036	Plastic arm, spud and nut	White ABS	1/25
T01037	Plastic arm, spud and nut	Bone ABS	1/25

* The manufacturers' names are used only to describe whose products the tank levers will fit. The tank levers are not manufactured by those companies.

Tank Trip Levers for Eljer*



• Side mount
• 9" arm

PART NO.	DESCRIPTION	FINISH	CTN/MSTR
T01021	Brass arm with non-crack nylon spud and nut	PB Metal	25/150



• Side mount
• 8" brass arm

PART NO.	FINISH	CTN/MSTR
T0102BN	Brushed Nickel	1/50
T0102RB	Oil Rubbed Bronze	1/50
T0102WB	Old World Bronze	1/50

* The manufacturers' names are used only to describe whose products the tank levers will fit. The tank levers are not manufactured by those companies.

Tank Trip Levers for Kohler*



• Side mount
• 8" brass arm

PART NO.	FINISH	CTN/MSTR
T0108BN	Brushed Nickel	1/50
T0108RB	Oil Rubbed Bronze	1/50
T0108WB	Old World Bronze	1/50
T01181	Polished Brass	1/50



• Front mount
• 8" arm

PART NO.	DESCRIPTION	FINISH	CTN/MSTR
T01017	Wellworth/Barrington Lite new style / side mount 1.6 gal. unit replacement	PB Metal	1/125
T01015	Cast brass arm with metal spud and nut	PB Metal	1/125

* The manufacturers' names are used only to describe whose products the tank levers will fit. The tank levers are not manufactured by those companies.

Tank Trip Lever for Mansfield*



• Front mount
• 9" arm

PART NO.	DESCRIPTION	FINISH	CTN/MSTR
T01073	#41* plastic arm, spud and nut	PB ABS	25/200

* The manufacturers' names are used only to describe whose products the tank levers will fit. The tank levers are not manufactured by those companies.

A

Tank Trip Levers for ToTo*



- Side mount
- 10" brass arm
- Plastic spud and nut

PART NO.	FINISH	CTN/MSTR
T018BN	Brushed Nickel	1/30
T018RB	Oil Rubbed Bronze	1/30
T018WB	Old World Bronze	1/30

* The manufacturers' names are used only to describe whose products the tank levers will fit. The tank levers are not manufactured by those companies.

Tank Trip Levers for Universal Rundle/Sears*



- Front mount
- 8" arm

PART NO.	DESCRIPTION	FINISH	CTN/MSTR
T01067	Brass arm with plastic spud and nut fits Universal Rundle/Sears*	PB Metal	25/200

* The manufacturers' names are used only to describe whose products the tank levers will fit. The tank levers are not manufactured by those companies.

Universal Tank Trip Levers



- Front mount
- 8" arm
- Brass handle and arm

PART NO.	FINISH	CTN/MSTR
T01000	Chrome Plated	6/24
T0100BN	Brushed Nickel	6/24
T0100RB	Oil Rubbed Bronze	6/24
T0100WB	Old World Bronze	6/24
T0100PB	Polished Brass	6/24



- Can be used as a front mount or side mount
- 8" adjustable arm

PART NO.	FINISH	CTN/MSTR
T01330	Chrome	10/50
T0133BN	Brushed Nickel	10/50
T0133RB 	Oil Rubbed Bronze	10/50
T0133WB	Old World Bronze	10/50



- Front mount
- 8" arm
- Elite, heavy duty

PART NO.	FINISH	CTN/MSTR
T0105BN	Brushed Nickel	10/50
T0105RB	Oil Rubbed Bronze	10/50
T0105WB	Old World Bronze	10/50

 Items marked with the Jones Stephens logo are "You Need It...We Got It" Items.

FAUCETS & BATH ACCESSORIES

Kitchen Faucets 31-32

Bathroom Faucets..... 33-34

Tub and Shower Faucets 34-36

Specialty Faucets..... 36

Replacement Parts 37

Bath Accessories 38-40

*Published March 2017. List prices can be found in list price book and on our website.

Commercial Style Spring Neck Kitchen Faucet



- For single hole installations
- Metal body and ceramic cartridge
- ABS spray head with two spray modes – aerator & full spray
- Stainless steel hose
- Overall height 16.5"
- Replacement cartridge, 660143
- 2.0 GPM

PART NO.	FINISH	CTN/MSTR
1558040	Chrome Plated	1/3

Pull-Out Kitchen Deck Faucet



- Use with base plate for 8" 3-hole installation
- Use without base plate for 1-hole installation
- Ceramic cartridge and metal body
- Replacement cartridge, 660143
- Copper supply tubes with 1/2" MPT connectors
- Designer loop-lever handles
- Matching pull-out spray head
- Spray or stream functions with rubber jets for easy cleaning
- 2.0 GPM

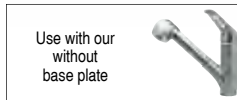

PART NO.	FINISH	CTN/MSTR
1558020	Chrome Plated	1/6
1558021	Satin Nickel	1/6

FAU

Hi-Arc Pulldown Kitchen Faucet



- Use with baseplate for 3-hole installation
- Use without baseplate for 1-hole installation
- Ceramic cartridge and extra heavy metal body
- Black nylon reinforced spray hose
- ABS spray head with two spray modes – aerator & full spray
- Replacement cartridge, 660143
- 2.0 GPM

PART NO.	FINISH	CTN/MSTR
1558060	Chrome Plated	1/3
1558061	Satin Nickel	1/3

Single Handle Kitchen Faucet



- Fits 8" center
- Ball style cartridge and POM waterways, metal cover
- Spray models can work with or without matching spray
- Designer lever handle
- Copper inlets with 1/2" MPT connectors
- Chrome Plated replacement handle, 660071
- Satin Nickel replacement handle, 660081
- Replacement ball, C1807A
- 2.0 GPM

PART NO.	FINISH	CTN/MSTR
1558010	Chrome Plated with spray	1/6
1558012	Chrome Plated without spray	1/6
1558011	Satin Nickel with spray	1/6
1558013	Satin Nickel without spray	1/6

Teapot Style Pull-Out Kitchen Deck Faucet



- Use with base plate for 8" 3-hole installation
- Use without base plate for 1-hole installation
- Ceramic cartridge and metal body
- Replacement cartridge, 660143
- Copper supply tubes with 1/2" MPT connectors
- Matching pull-out spray head
- Spray or stream functions with rubber jets for easy cleaning
- 2.0 GPM



PART NO.	FINISH	CTN/MSTR
1558070	Chrome Plated	1/3
1558071	Satin Nickel	1/3
1558072	Oil Rubbed Bronze	1/3

Two Handle Gooseneck Kitchen Faucet



- Fits 8" center
- POM cartridge and waterways, metal cover
- Metal threaded shaft
- Matching wave-lever handles
- Spray models can work with or without matching spray
- Chrome Plated replacement handles, 660001
- Satin Nickel replacement handles, 660011
- Replacement cartridges, C1742C and C1742H
- 2.0 GPM

PART NO.	FINISH	CTN/MSTR
1558030	Chrome Plated with spray	1/6
1558032	Chrome Plated without spray	1/6
1558031	Satin Nickel with spray	1/6
1558033	Satin Nickel without spray	1/6

Two Handle Kitchen Faucet

FAU



- Fits 8" center
- POM cartridge and waterways, metal cover
- Metal threaded shaft
- Matching wave lever handles
- Spray models can work with or without matching spray
- Chrome Plated replacement handles, 660001
- Satin Nickel replacement handles, 660011
- Replacement cartridges, C1742C and C1742H
- 2.0 GPM

PART NO.	FINISH	CTN/MSTR
1558001	Chrome Plated with spray	1/6
1558003	Chrome Plated without spray	1/6
1558002	Satin Nickel with spray	1/6
1558004	Satin Nickel without spray	1/6

Two Handle High Spout Kitchen Faucet



- Fits 8" center
- POM waterways, metal cover
- Uses Delta® style cartridges, seats, and handles
- Metal threaded shaft
- Replacement stem, C1740CH
- 2.0 GPM

PART NO.	FINISH	CTN/MSTR
1558050	Chrome Plated with spray	1/6
1558052	Chrome Plated without spray	1/6

Single Handle Kitchen Faucet



- Fits 8" center
- Stainless steel, copper waterways, metal cover
- Copper inlets with 1/2" MPT connectors
- Lever handle
- Uses Delta® style ball, seats, and handle
- Replacement ball, C1807A
- 2.0 GPM

PART NO.	FINISH	CTN/MSTR
1550110	Chrome Plated with spray	1/12
1550010	Chrome Plated without spray	1/12

Two Acrylic Handle High Spout Kitchen Faucet



- Fits 8" center
- POM waterways, metal cover, acrylic handles
- Metal threaded shaft
- Uses Delta® style stem, seats, and handles
- Replacement stem, C1740CH
- 2.0 GPM

PART NO.	FINISH	CTN/MSTR
1550505	Chrome Plated with spray	1/12
1550500	Chrome Plated without spray	1/12

Two Acrylic Handle Kitchen Faucet



- Fits 8" center
- POM waterways, metal cover, acrylic handles
- Metal threaded shaft
- Uses Delta® style stem, seats, and handles
- Replacement stem, C1740CH
- 2.0 GPM

PART NO.	FINISH	CTN/MSTR
1550450	Chrome Plated with spray	1/12
1550400	Chrome Plated without spray	1/12

Single Handle Kitchen Faucet with Deck Mounted Spray



- Fits 8" center, 3-hole installation
- Stainless steel ball, POM waterways
- Copper inlets with 1/2" MPT connectors
- Replacement handle, 660071
- Uses Delta® style ball, seats, and handle
- Replacement ball, C1807A
- 2.0 GPM

PART NO.	FINISH	CTN/MSTR
1558015	Chrome Plated with spray	1/12

Two Acrylic Handle High Spout Kitchen Faucet



- Fits 8" center
- Brass compression stem, replaceable seats, Chrome Plated canopy handles
- Uses Gerber® style stems, seats, handles, and spout
- Solid brass body with brass shanks
- Replacement stems, C1740CH and C1756C
- 2.0 GPM

PART NO.	FINISH	CTN/MSTR
1812103	Chrome Plated with spray	1/6
1812101	Chrome Plated without spray	1/6

Two Handle High-Spout Teapot Bathroom Faucet



- Fits 4" center
- High gooseneck swivel spout for greater coverage and clearance
- POM cartridge and waterways, metal cover
- Metal threaded shaft
- Matching wave lever handles
- With matching plastic pop-up
- Replacement cartridge, C1742C and C1742H
- 1.5 GPM

PART NO.	FINISH	CTN/MSTR
1554040	Chrome Plated with pop-up	1/6
1554041	Satin Nickel with pop-up	1/6
1554042	Oil Rubbed Bronze with pop-up	1/6

Wide-Spread Bathroom Faucet



- Hi-arc design for maximum clearance
- POM cartridge for durability and ease of use
- Brass body with POM waterways
- Matching wave lever handles
- With matching plastic pop-up
- Chrome Plated replacement handles, 660001
- Satin Nickel replacement handles, 660011
- 1.5 GPM

PART NO.	FINISH	CTN/MSTR
1554050	Chrome Plated with pop-up	1/3
1554051	Satin Nickel with pop-up	1/3

Two Handle High-Spout Bathroom Faucet



- Fits 4" center
- High spout design for maximum clearance
- POM cartridge and waterways, metal cover
- Metal threaded shaft
- Matching wave lever handles
- With matching plastic pop-up
- Chrome Plated replacement handles, 660001
- Satin Nickel replacement handles, 660011
- Replacement cartridges, C1742C and C1742H
- 1.5 GPM

PART NO.	FINISH	CTN/MSTR
1554030	Chrome Plated with pop-up	1/6
1554031	Satin Nickel with pop-up	1/6
1554032	Oil Rubbed Bronze with pop-up	1/6

Single Handle Bathroom Faucet



- Fits 4" center
- Ball style cartridge and POM waterways, metal cover
- Copper inlets with metal threaded shaft
- Replacement handle, 660041
- With matching plastic pop-up
- Replacement cartridges, C1742C and C1742H
- 1.5 GPM

PART NO.	FINISH	CTN/MSTR
1554010	Chrome Plated with pop-up	1/6
1554011	Satin Nickel with pop-up	1/6

Two Handle Bathroom Faucet



- Fits 4" center
- POM cartridge and waterways, metal cover
- Metal threaded shaft
- With matching plastic pop-up
- Matching wave lever handles
- Chrome Plated replacement handles, 660001
- Satin Nickel replacement handles, 660011
- Replacement cartridges, C1742C and C1742H
- 1.5 GPM

PART NO.	FINISH	CTN/MSTR
1554001	Chrome Plated with pop-up	1/6
1554002	Satin Nickel with pop-up	1/6

Single Acrylic Handle Bathroom Faucet



- Fits 4" center
- Acrylic globe style handle, metal body
- Copper inlets with 1/2" MPT connectors
- Uses Delta® style ball, seats, and handle
- Replacement stem, C1740CH
- 1.5 GPM

PART NO.	FINISH	CTN/MSTR
1550210	Chrome Plated with pop-up	1/12
1550200	Chrome Plated without pop-up	1/12

Single Handle Bathroom Faucet



- Fits 4" center
- Metal handle, metal body
- Copper inlets with 1/2" MPT connectors
- Uses Delta® style ball, seats, and handle
- Replacement ball, C1809A
- 1.5 GPM

PART NO.	FINISH	CTN/MSTR
1550203	Chrome Plated with brass pop-up	1/12
1550205	Chrome Plated without brass pop-up	1/12

Two Handle Bathroom Faucet

FAU

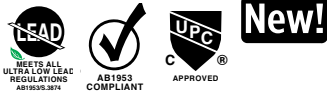

New!

- Fits 4" center
- New modern rounded body design
- POM waterways, metal cover, acrylic handles
- Metal threaded shaft
- Uses Delta® style stem, seats, and handles
- Replacement stem, C1740CH
- 1.5 GPM

PART NO.	FINISH	CTN/MSTR
1550601	Chrome Plated with pop-up	1/12
1550600	Chrome Plated without pop-up	1/12

Two Handle Bathroom Faucet



New!

- Fits 4" center
- POM waterways, metal cover, acrylic handles
- Metal threaded shaft
- Uses Delta® style stem, seats, and handles
- Replacement stem, C1740CH
- 1.5 GPM

PART NO.	FINISH	CTN/MSTR
1550350	Chrome Plated with plastic pop-up	1/12
1550300	Chrome Plated with brass pop-up	1/12
1550250	Chrome Plated without pop-up	1/12

Two Handle Handicap Bathroom Faucet



New!

- Fits 4" center
- POM waterways, metal cover, acrylic handles
- Metal threaded shafts
- Drain assembly
- Uses Delta® style stem, seats, and handles
- Stainless steel clad plastic grid
- Replacement stem, C1740CH
- 1.5 GPM

PART NO.	FINISH	CTN/MSTR
1550301	Chrome Plated with grid drain	1/12

Two Handle Heavy Pattern Bathroom Faucet

Roslyn Style



New!

- Fits 4" center
- Brass compression stem, replaceable seats, Chrome Plated canopy handles
- Solid brass body with brass shanks
- Uses Gerber® style replacement parts
- Replacement stems, C1756H and C1756C
- 1.5 GPM

PART NO.	FINISH	CTN/MSTR
1820070	Chrome Plated with brass pop-up	1/12

Single Handle Tub/Shower Faucet



New!

- Ceramic cartridge, solid brass construction
- Pressure balanced/scald guard design
- Integral stops
- With tub diverter spout, shower head, and shower arm
- With lever handle for ADA compliance
- Replacement cartridge, 1550223
- 2.5 GPM

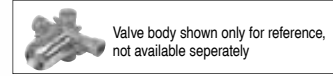

PART NO.	FINISH	CTN/MSTR
1550221	Chrome Plated	1/6
1550222	Satin Nickel	1/6

Single Acrylic Handle Tub/Shower Faucet



New!

- Brass ball, brass body, acrylic globe style handle
- Uses Delta® Style replacement parts
- Chrome Plated trim
- With tub diverter spout, shower head, and shower arm
- Replacement ball, C1809A
- 2.5 GPM

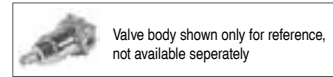

PART NO.	FINISH	CTN/MSTR
1550220	Chrome Plated	1/12

Three Handle Tub/Shower Faucet



New!

- Fits 8" center
- Brass compression stems, replaceable seats, canopy handles
- With tub spout, bell escutcheons, shower head, and shower arm
- Uses Price Pfister® style replacement parts
- Replacement stems, C1754CH and C1759D
- 2.5 GPM

PART NO.	FINISH	CTN/MSTR
1855050	Chrome Plated	1/10

Three Handle Tub/Shower Faucet, 11" Center



New!

- Fits 11" center
- Brass compression stems, replaceable seats, and canopy handles
- With tub spout, bell escutcheons, shower arm, shower arm flange, and shower head
- Solid brass construction
- Uses Price Pfister® style replacement parts
- Replacement stem, C1754CH
- 2.5 GPM

PART NO.	FINISH	CTN/MSTR
1855052	Chrome Plated	1/4

Three Handle Heavy Pattern Tub/Shower Faucet



New!

- Fits 8" center
- Brass compression stems, replaceable seats, Chrome Plated canopy handles
- With tub spout, shower head, low pattern escutcheons, and shower arm
- Uses Gerber® style stems, seats, handles, and spout
- Replacement stems, C1759D and C1757CH
- 2.5 GPM

PART NO.	FINISH	CTN/MSTR
1855051	Chrome Plated	1/6

FAU

Two Handle Tub/Shower Faucet



New!

- Fits 8" center
- Brass compression stems, replaceable seats, canopy handles
- With tub diverter spout, bell escutcheons, shower head, and shower arm
- Uses Price Pfister® style replacement parts
- Replacement stem, C1754CH
- 2.5 GPM

PART NO.	FINISH	CTN/MSTR
1854030	Chrome Plated	1/10

Two Handle Stall Shower Faucet



New!

- Fits 4" center
- Brass compression stems, replaceable seats, Chrome Plated canopy handles
- With shower head, low pattern escutcheons and shower arm
- 2.5 GPM

PART NO.	FINISH	CTN/MSTR
1850022	Chrome Plated	1/12

Two Handle Shower Faucet



New!

- Fits 8" center
- Brass compression stems, replaceable seats, canopy handles
- With shower head, bell escutcheons, and shower arm
- Uses Price Pfister® style replacement parts
- Replacement stem, C1754CH
- 2.5 GPM

PART NO.	FINISH	CTN/MSTR
1854010	Chrome Plated	1/12

Three Acrylic Handle Tub/Shower Faucet



New!

- Fits 8" center
- 1/4" - turn washerless stems
- Acrylic handles
- With tub spout, shower head, shower arm, and low pattern escutcheons
- Uses Delta® style replacement parts
- 2.0 GPM

PART NO.	FINISH	CTN/MSTR
1855055	Chrome Plated	1/10

Two Handle Tub Faucet



New!

- Fits 8" center
- Brass compression stems, replaceable seats, canopy handles
- With tub spout and bell escutcheons
- Uses Price Pfister® style replacement parts
- Replacement stem, C1754CH

PART NO.	FINISH	CTN/MSTR
1854020	Chrome Plated	1/16

Two Acrylic Handle Tub/Shower Faucet



New!

- Fits 8" center
- 1/4" - turn washerless stems
- With tub diverter spout, shower head, shower arm, and low pattern escutcheons
- Acrylic handles
- Uses Delta® style replacement parts
- Replacement stem, C1740CH
- 2.0 GPM

PART NO.	FINISH	CTN/MSTR
1854015	Chrome Plated	1/10

Two Acrylic Handle Shower Faucet

New!



- Fits 8" center
- 1/4-turn washerless stems
- With shower head, shower arm, and low pattern escutcheons
- Acrylic handles
- Uses Delta® style replacement parts
- Replacement stem, C1740CH
- 2.0 GPM

PART NO.	FINISH	CTN/MSTR
1854035	Chrome Plated	1/10

Two Acrylic Handle Tub Faucet

New!



- Fits 8" center
- 1/4-turn washerless stems
- Acrylic handles
- With tub spout
- Uses Delta® style replacement parts
- Replacement stem, C1740CH

PART NO.	FINISH	CTN/MSTR
1854025	Chrome Plated	1/10

Two Handle Gooseneck Bar Faucet

New!



- Fits 4" center
- POM cartridge and waterways
- Metal threaded shaft
- Stainless steel spout
- Premium wave lever handles
- Chrome Plated replacement handles, 660001
- Satin Nickel replacement handles, 660011
- Replacement stems, C1742C and C1742H
- 2.0 GPM

PART NO.	FINISH	CTN/MSTR
1822025	Chrome Plated	1/12
1822026	Satin Nickel	1/12

Two Handle Gooseneck Bar Faucet

New!



- Fits 4" center
- POM cartridge and waterways
- Metal threaded shaft
- Stainless steel spout
- Premium wave lever handles
- Chrome Plated replacement handles, 660001
- Satin Nickel replacement handles, 660011
- Replacement stems, C1742C and C1742H
- 2.0 GPM

PART NO.	FINISH	CTN/MSTR
1822020	Chrome Plated	1/12

Pull-Out Laundry Tray Faucet



- Pull-out spray head for easy coverage of large sinks or for filling buckets
- Non-metallic construction for long lasting corrosion and impact resistance
- Fits 3-hole laundry tubs or sinks
- 4" center
- 1/4-turn washerless cartridges
- Aerator and spray functions
- Uses Delta® style replacement parts
- Replacement stem, C1740CH
- 2.5 GPM

PART NO.	FINISH	CTN/MSTR
1836015	Chrome Plated	1/12

Two Acrylic Handle Laundry Tray Faucet



- Fits 4" center
- Acrylic handles
- POM cartridge and waterways
- Metal threaded shaft, bottom mount
- Uses Delta® style stems, seats, and handles
- Spout threaded for garden hose connection
- Replacement stem, C1740CH

PART NO.	FINISH	CTN/MSTR
1836010	Chrome Plated	1/12

Two Handle Handicap Laundry Tray Faucet



- Fits 4" center
- Chrome Plated die cast wing lever handles
- POM cartridge and waterways
- Metal threaded shaft, bottom mount
- Uses Delta® style stems and seats.
- With adapter for garden hose connection
- Aerator spray for splash-free performance
- Replacement stem, C1740CH
- 4.0 GPM

PART NO.	FINISH	CTN/MSTR
1836050	Chrome Plated	1/12

Two Handle Rough Brass Laundry Tray Faucet



- Solid brass body Chrome Plated lever handles
- Mounts on faucet block for top supply with 1/2" IPS unions
- Uses 1/4 turn stems, seats, and handles
- With adapter for standard or hose thread outlet spout
- Replacement stems, C1742C and C1742H

PART NO.	FINISH	CTN/MSTR
1828010	Rough Brass	1/12

Ceramic Cartridge for Kitchen Faucets

New!



- Plastic square-broached stem
- Stem is internally threaded for handle screw
- Marked "DL02GJ"
- Fits 1558040, 1558060, 1558061, 1558070, 1558071, 1558072, 1558020, and 1558021

PART NO.	DESCRIPTION	CTN/MSTR
660143	Replacement cartridge for kitchen	1/25

Ceramic Cartridge for Tub/Shower Faucets

New!



- Plastic square-broached stem
- Adjustable lock-nut reinforcer
- Stem is internally threaded for handle screw
- Scald guard pressure balanced
- Marked "HJ-40"
- Fits 1550221 and 1550222

PART NO.	DESCRIPTION	CTN/MSTR
1550223	Replacement cartridge for tub/shower	1/50

Stem and Seats for Two Handle Faucets

New!



- Also fits some Glacier Bay®, Premier®, and ProPlus® faucets

PART NO.	DESCRIPTION	CTN/MSTR
C1742C	Stem and seat for two handle - Cold	4/48
C1742H	Stem and seat for two handle - Hot	4/48

Replacement Handles for Lavatory and Kitchen Faucets

New!



PART NO.	DESCRIPTION	CTN/MSTR
660001	Chrome Plated handles for kitchen and bathroom faucets (Pair)	1/25
660011	Satin Nickel handles for kitchen and bathroom faucets (Pair)	1/25
660041	Chrome Plated single handle for bathroom faucet	1/25
660042	Satin Nickel single handle for bathroom faucet	1/25
660071	Chrome Plated single handle for kitchen faucet	1/25
660081	Satin Nickel single handle for kitchen faucet	1/25

Replacement Handles for Classic Faucets

New!



- Stems come together with seats

PART NO.	DESCRIPTION	CTN/MSTR
C1807A	Stainless steel ball for single handle kitchen faucet	6/144
C1809A	Stainless steel ball for single handle bathroom faucet	6/144
C1756C	Cold stem for heavy kitchen and bathroom faucet	4/48
C1756H	Hot stem for heavy kitchen and bathroom faucet	4/48
C1754CH	Stem for compression tub/shower faucet	4/48
C1757CH	Stem for heavy tub/shower faucet	4/48
C1759D	Diverter stem for compression tub/shower faucet	4/48
C1744D	Diverter stem for heavy tub/shower faucet	4/48
C1740CH	Stem, seat, and spring for washerless faucet	4/48

Replacement Handles

New!



PART NO.	DESCRIPTION	CTN/MSTR
C384	Chrome Plated hot & cold handles for compression tub/shower faucets (Pair)	6/72
C382	Chrome Plated diverter handle for tub/shower faucet	6/72
C406	Chrome Plated H & C handles for heavy tub/shower (Pair)	6/72
C406A	Chrome Plated diverter handle for heavy tub/shower	6/72

Towel Bar with Posts, Bell Style with Concealed Screw

New!

FAU



- Furnished with screws and end mounting brackets
- Die cast zinc
- Bell style shape

PART NO.	DESCRIPTION	CTN/MSTR
97308	18" Chrome	1/25
97309	18" Satin Nickel	1/25
97310	24" Chrome	1/25
97311	24" Satin Nickel	1/25

Towel Bar, Square Style with Concealed Screw

New!



- Concealed screw
- Furnished with screws and end mounting brackets
- Square bottom shape on mounting bracket
- Zinc

PART NO.	DESCRIPTION	CTN/MSTR
03038	3/4" x 18" Chrome	5/30
03040	3/4" x 24" Chrome	5/30
03033	5/8" x 24" Satin Nickel	5/30

Towel Bar, Tower Style with Concealed Screw

New!



- Concealed screw
- Furnished with screws and end mounting brackets
- Tower style on mounting bracket
- Zinc
- Boxed

PART NO.	DESCRIPTION	CTN/MSTR
97887	3/4" x 24" Brushed Nickel	24/48

Towel Bar, Tower Style with Exposed Screw

New!



- Exposed screw
- Furnished with screws and end mounting brackets
- Tower style on mounting bracket
- Zinc

PART NO.	DESCRIPTION	CTN/MSTR
03036	5/8" x 24" Chrome	5/30
03051	5/8" x 24" Brushed Nickel	5/30
97886	3/4" x 24" Brushed Nickel	5/30

Towel Bar Brackets, Square Style with Concealed Screw

New!



- Concealed screw
- Furnished with mounting plate and screws
- Square bottom shape
- Zinc
- 1 pair/Boxed

PART NO.	DESCRIPTION	CTN/MSTR
97177	5/8" Chrome	1/50
97172	5/8" Satin Nickel	1/50
97180	3/4" Chrome	5/50
97170	3/4" Satin Nickel	5/50

Towel Bar Brackets Tower, Style with Exposed Screw

New!



- Exposed screw
- Furnished with mounting plate and screws
- Zinc
- 1 pair/Boxed

PART NO.	DESCRIPTION	CTN/MSTR
97184	5/8" Chrome	50/100
97174	5/8" Satin Nickel	50/100
97183	3/4" Chrome	50/100
97173	3/4" Satin Nickel	50/100

Aluminum Towel Bar

New!



- Bar only
- Mill finished
- Aluminum

PART NO.	DESCRIPTION	CTN/MSTR
4116	3/4" x 18" Aluminum	1/50
4117	3/4" x 24" Aluminum	1/50
4118	3/4" x 30" Aluminum	1/50

Stainless Steel Towel Bar

New!



- Bar only
- Polished stainless

PART NO.	DESCRIPTION	CTN/MSTR
4140	3/4" x 18" Stainless Steel	1/50
4141	3/4" x 24" Stainless Steel	1/50
4143	3/4" x 36" Stainless Steel	1/50
4141SN	3/4" x 24" Satin Nickel SS	1/50
4130	5/8" x 18" Stainless Steel	1/50
4131	5/8" x 24" Stainless Steel	1/50
4131SN	5/8" x 24" Satin Nickel SS	1/50

Towel Ring, Bell Style with Concealed Screw



- Furnished with screws and end mounting brackets
- Bell style shape
- Metal ring
- Die cast zinc
- Boxed

New!

PART NO.	FINISH	CTN/MSTR
97304	Chrome	1/25
97305	Satin Nickel	1/25

Towel Ring, Square Style with Concealed Screw



- Concealed screw
- Furnished with screws and mounting plate
- 3/8" diameter wire ring
- Zinc

New!

PART NO.	FINISH	CTN/MSTR
62062	Chrome	6/96
62070	Satin Nickel	6/96

Lucite Towel Ring, Square Style with Concealed Screw



- Concealed screw
- Furnished with screws and mounting bracket
- Chrome with lucite ring

New!

PART NO.	FINISH	CTN/MSTR
97892	Chrome	1/25

Lucite Towel Ring, Tower Style with Exposed Screw



- Concealed screw
- Furnished with screws and mounting bracket
- Chrome with lucite ring

New!

PART NO.	FINISH	CTN/MSTR
97894	Satin Nickel	25/50

Double Towel Hook, Bell Style with Concealed Screw



- Furnished with screws and end mounting brackets
- Bell style shape
- Die cast zinc

New!

PART NO.	FINISH	CTN/MSTR
97306	Chrome	1/50
97307	Satin Nickel	1/50

Double Towel Hook, Square Style with Concealed Screw



- Concealed screw
- Furnished with screws and mounting plate

New!

PART NO.	FINISH	CTN/MSTR
97897	Chrome	1/50
97896	Satin Nickel	1/50

Toothbrush Holder, Square Style with Concealed Screw



- Concealed screw
- Furnished with mounting hardware
- Die cast

New!

PART NO.	FINISH	CTN/MSTR
97195	Chrome	1/50
97196	Satin Nickel	1/50

Toothbrush Holder, Tower Style with Exposed Screw



- Exposed screw
- Furnished with mounting hardware
- Die cast

New!

PART NO.	FINISH	CTN/MSTR
97890	Chrome	50/100
97891	Satin Nickel	50/100

Chrome Toothbrush Holder with Plastic Tray, Tower Style with Exposed Screw



- Exposed screw
- Furnished with mounting hardware

New!

PART NO.	FINISH	CTN/MSTR
97194	Chrome	50/100

Replacement Soap Tray



- 4-5/8" x 2-5/8"
- Clear plastic tray
- 5 Pack

New!

PART NO.	DESCRIPTION	CTN/MSTR
97203U	Plastic	25/50

Soap Dish, Square Style with Concealed Screw



- Concealed screw
- Die cast zinc
- Furnished with mounting plate and hardware

New!

PART NO.	FINISH	CTN/MSTR
97192	Chrome	5/50
97193	Satin Nickel	5/50

Soap Dish, Tower Style with Exposed Screw



- Exposed screw
- Furnished with screws
- Die cast

New!

PART NO.	FINISH	CTN/MSTR
36208	Chrome	50/100
97889	Satin Nickel	50/100

Euro Toilet Paper Holder, Bell Style with Concealed Screw



- Furnished with screws and end mounting brackets
- Bell style shape
- Metal bar
- Die cast zinc

New!

PART NO.	FINISH	CTN/MSTR
97302	Chrome	1/25
97303	Satin Nickel	1/25

Toilet Paper Holder, Bell Style with Concealed Screw



- Furnished with screws and end mounting brackets
- Color matched plastic roller
- Bell style shape
- Die cast zinc

New!

PART NO.	FINISH	CTN/MSTR
97300	Chrome	1/25
97301	Satin Nickel	1/25

Toilet Paper Holder, Square Style with Concealed Screw



- Concealed screw
- Spring loaded white plastic roller
- Square base post
- Furnished with screws and end mounting brackets
- Zinc

New!

PART NO.	FINISH	CTN/MSTR
97187	Chrome	6/96
36214	Satin Nickel	6/96

Toilet Paper Holder, Tower Style with Concealed Screw



- Concealed screw
- Spring loaded white plastic roller
- Furnished with screws and end mounting brackets
- Tower base post
- Zinc

New!

PART NO.	FINISH	CTN/MSTR
97188	Chrome	50/100
97189	Satin Nickel	50/100

Toilet Paper Holder Brackets, Tower Style with Concealed Screw



- Concealed screw
- 2-1/4" x 1-1/4" base; 2-15/16" depth
- Furnished with mounting plate and screws
- Tower style
- Zinc
- 1 pair/Boxed

New!

PART NO.	DESCRIPTION	CTN/MSTR
97185	5/8" Chrome	50/100
97186	5/8" Satin Nickel	50/100
97181	3/4" Chrome	50/100
97182	3/4" Satin Nickel	50/100

Toilet Paper Holder, Tower Style with Exposed Screw



- Exposed screw
- Spring loaded white plastic roller
- Furnished with screws
- Tower base post
- Zinc

New!

PART NO.	FINISH	CTN/MSTR
36206	Chrome	6/96
97888	Satin Nickel	50/100

SECTION B - SPECIALTIES & REPAIR

Toilet Repairs	43-55
Kitchen & Bath	56-81
Plumbing Connectors/Supply Stops	82-84
Utility Sinks and Accessories	85
Drinking Fountain Bubbler/Sink Faucets & Accessories	86
Gas Connectors	87-92



*Published March 2017. List prices can be found in list price book and on our website.

TANK LEVER TO TANK REFERENCE CHART

MFR.	PART NO.	FINISH	SECTION PAGE NO.	TANK STYLE
American Standard*	T01030	CP ABS	B2	Glenwall with vent #4049.177 Compack with vent #4052.346 Norwall with vent #4041.091
	T01031	PB ABS	DECORATIVE (SECT. A)	
	T01032 T01033	White ABS Bone ABS		
	T01042	CPS ABS	B2	Cadet II #4072 Cadet #4029 Cadet II #4014 Ellisse #4075 High Hamilton - 1 pc. #2096 Hamilton - 1 pc. #2092
	T01043	PB ABS	DECORATIVE (SECT. A)	Carlyle #2010.031 New Cadet line
	T01044	White ABS		
	T01045	Bone ABS		
	T01048	CPS ABS	B2	Glenwall #2093 Cadet #2108 Cadet #2109 Cadet #2120 Cadet #2124 Plebe #2131 Plebe #2138 Plebe #2139 Plebe Aquameter
	T01049	PB ABS	DECORATIVE (SECT. A)	
	T01050	CPS ABS	B2	
	T01051	PB ABS	DECORATIVE (SECT. A)	
	T01052	White ABS		
T01053	Bone ABS			
T01064	CP Metal	B2		
T01065	PB Metal	DECORATIVE (SECT. A)		
Crane*	T01034	CPS ABS	B2	Galaxy New Galaxy Sante Fe Avon Antigua
Eljer*	T01020	CP Metal	B3	New Emblem
	T01021	PB Metal	DECORATIVE (SECT. A)	
Kohler*	T01010	CP Metal	B3	Wellworth*/Barrington* - Old Style
	T01012	CP Metal	B3	
	T01015	PB Metal	DECORATIVE (SECT. A)	Kohler 9400
	T01016	CP Metal	B3	Wellworth*/Barrington Lite* - Old Style
	T01017	PB Metal	DECORATIVE (SECT. A)	
Mansfield*	T01040	CPS ABS	B3	Mansfield #35 Mansfield #51 Mansfield #8 Mansfield #16 Mansfield #35LT
	T01073	PB ABS	DECORATIVE (SECT. A)	
	T01072	CP Metal	B3	
	T01041	PB Metal	DECORATIVE (SECT. A)	Mansfield old style #42
Universal Rundle*/Sears*	T01066	CP Metal	B3	Saturn 4012 Low Boy 4445
	T01067	PB Metal	DECORATIVE (SECT. A)	

*The manufacturers' names are used only to describe whose products the tank levers will fit. The tank levers are not manufactured by those companies.



Fit-All Tank Trip Lever



PART NO.	DESCRIPTION	FINISH	CTN/ MSTR
T01001	Brass arm with metal spud and nut	CP Metal	25/200
T01002	Brass plated arm with metal spud and nut	CP Metal	25/200
T01200	Aluminum arm with zinc spud and nut	CP Metal	25/200
T01201	Aluminum arm with plastic spud and nut	CP Metal	25/200
T01099	Replacement spud nut	Zinc	1/25

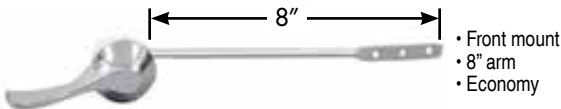

PART NO.	DESCRIPTION	FINISH	CTN/ MSTR
T01060	Brass plated arm with plastic spud and nut/universal fit	CP Metal	25/200

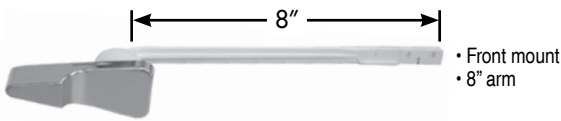

PART NO.	DESCRIPTION	FINISH	CTN/ MSTR
T01062	Plastic arm, spud and nut/universal fit	CP ABS	25/125

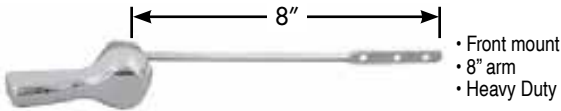

PART NO.	DESCRIPTION	FINISH	CTN/ MSTR
T01005	Brass arm with metal spud and nut/universal fit	CP Metal	25/150

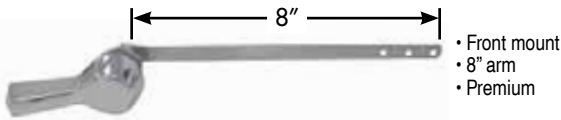

PART NO.	DESCRIPTION	FINISH	CTN/ MSTR
T01068	Flat brass arm with metal spud and nut/universal fit	CP Metal	25/200

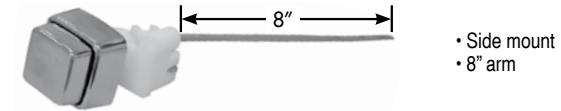

PART NO.	DESCRIPTION	FINISH	CTN/ MSTR
T01070	Push button brass arm with plastic spud and nut/universal fit	CP ABS	25/50

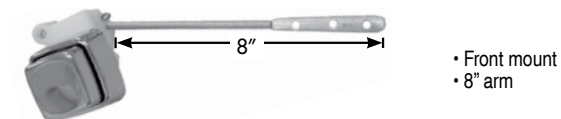

PART NO.	DESCRIPTION	FINISH	CTN/ MSTR
T01074	Push button brass arm with plastic spud and nut/universal fit	CP ABS	25/50

Tank Trip Levers for American Standard*

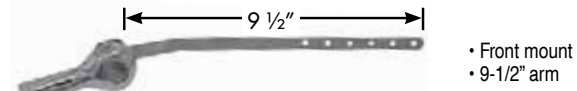

PART NO.	DESCRIPTION	FINISH	CTN/ MSTR
T01064	Brass arm with metal spud and nut offset for thick tank walls	CP Metal	25/150

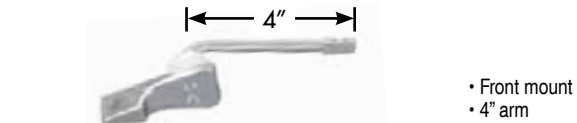

PART NO.	DESCRIPTION	FINISH	CTN/ MSTR
T01030	Plastic arm, spud and nut for beaded chain	CP ABS	25/250

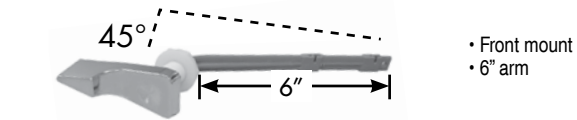

PART NO.	DESCRIPTION	FINISH	CTN/ MSTR
T01042	45° arm for Cadet 2* plastic arm, spud and nut	CP ABS	1/200

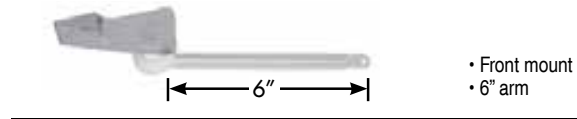

PART NO.	DESCRIPTION	FINISH	CTN/ MSTR
T01050	Plastic arm, spud and nut for Plebe* and Cadet*	CP ABS	1/25

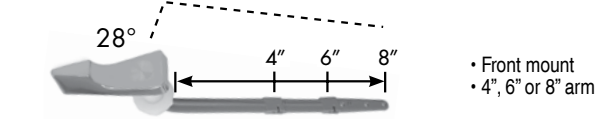

PART NO.	DESCRIPTION	FINISH	CTN/ MSTR
T01048	Neo 28° combo with plastic arm, spud and nut	CP ABS	1/200

* The manufacturers' names are used only to describe whose products the tank levers will fit. The tank levers are not manufactured by those companies.

Tank Trip Lever for Crane*

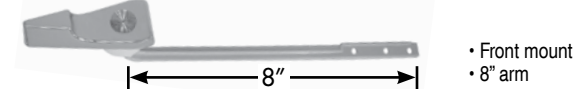

PART NO.	DESCRIPTION	FINISH	CTN/ MSTR
T01034	Plastic arm, spud and nut	CP ABS	25/250

* The manufacturers' names are used only to describe whose products the tank levers will fit. The tank levers are not manufactured by those companies.

Tank Trip Lever for Eljer*

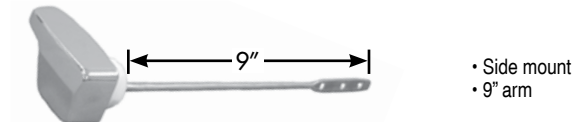

PART NO.	DESCRIPTION	FINISH	CTN/ MSTR
T01020	Brass arm with non-crack nylon spud and nut	CP Metal	25/200

* The manufacturers' names are used only to describe whose products the tank levers will fit. The tank levers are not manufactured by those companies.

Items marked with the Jones Stephens logo are "You Need It... We Got It" Items.

Tank Trip Levers for Kohler*

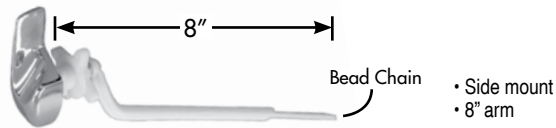

PART NO.	DESCRIPTION	FINISH	CTN/ MSTR
T01010	Wellworth*/Barrington* Old style/ Plastic arm (less bead hook), spud and nut	CP Metal	25/125
T01016	Wellworth*/Barrington Pressure Lite®* New style/ 1.6 gal. unit replacement Plastic arm, spud and nut	CP Metal	25/125



PART NO.	DESCRIPTION	FINISH	CTN/ MSTR
T01012	Cast brass arm with metal spud and nut	CP Metal	25/125

* The manufacturers' names are used only to describe whose products the tank levers will fit. The tank levers are not manufactured by those companies.

Tank Trip Levers for Mansfield*

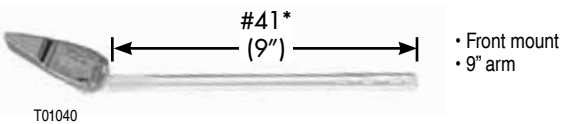

PART NO.	DESCRIPTION	FINISH	CTN/ MSTR
T01040	#41* Plastic arm, spud and nut	CP ABS	1/25

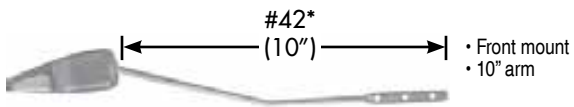

PART NO.	DESCRIPTION	FINISH	CTN/ MSTR
T01072	#42* Brass arm with plastic spud and nut	CP Metal	25/100

* The manufacturers' names are used only to describe whose products the tank levers will fit. The tank levers are not manufactured by those companies.

Tank Trip Lever for Universal Rundle*/Sears*

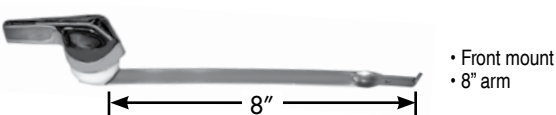

PART NO.	DESCRIPTION	FINISH	CTN/ MSTR
T01066	Brass arm with plastic spud and nut	CP Metal	25/200

* The manufacturers' names are used only to describe whose products the tank levers will fit. The tank levers are not manufactured by those companies.

Ultrafit Tank Trip Lever

- Bagged
- Patented!
- Heavy Duty plastic arm, spud and nut
- Display Available- Part No. T04001
- Shapeable arm bends to fit the needed arm angle
- Arm can be cut to 4", 6" or 8" lengths for customized fit
- Fits American Standard*, Eljer*, Kohler*, Mansfield* and ToTo*

PART NO.	DESCRIPTION	FINISH	CTN/MSTR
T01100	Ultrafit tank lever	CP ABS	25/200

* The manufacturers' names are used only to describe whose products the tank levers will fit. The tank levers are not manufactured by those companies.

Tank Trip Lever for Western Pottery*



PART NO.	DESCRIPTION	FINISH	CTN/MSTR
T01080	Brass arm with plastic spud and nut	CP Metal	25/200

* The manufacturers' names are used only to describe whose products the tank levers will fit. The tank levers are not manufactured by those companies.

Tank Trip Lever for ToTo*



PART NO.	DESCRIPTION	FINISH	CTN/MSTR
T01081	Brass arm with plastic spud and nut	CP Metal	25/200

* The manufacturers' names are used only to describe whose products the tank levers will fit. The tank levers are not manufactured by those companies.

CleanWave™ Sensor Activated Flush

New!



- To flush, simply wave your hand over the handle
- Also functions as a standard flush handle
- Easy to install on existing front mount toilet tanks, no tools needed
- Operates on four AA batteries (not included)
 - F20023 (Duracell AA, 4 pack)
 - F20008 (Rayovac AA, 8 pack)
- 45 seconds in between flushes
- 4,000 flushes per battery/350,000 flushes per life of unit
- 1 year warranty
- Visit our YouTube channel to watch the demo video
- **COMING SOON**
 - Side and angle mount
 - Brushed Nickel and Oil Rubbed Bronze handles

PART NO.	DESCRIPTION	FINISH	CTN/ MSTR
G01850	Front mount sensor lever	CP Metal	1/30

Eljer* Touch Flush* Assembly



- Complete with tank, lever, chain, ball and arm
- CARTON QUANTITIES ONLY

PART NO.	DESCRIPTION	FINISH	CTN/MSTR
C04019	Touch Flush assembly	CP ABS	1/5

* The manufacturers' names are used only to describe whose products the products will fit.

Tank Ball and Seat Disc



- Rubber
- New boxing to protect shape of units
- Rated to 160°F
- CARTON QUANTITIES ONLY

PART NO.	DESCRIPTION	CTN/MSTR
C04020	Eljer* tank ball for touch flush	1/10
C04021	Fit-All tank ball less guide	1/10
C04030	2-1/4"- 2-5/8" Tri-seal tank ball	1/100
C04031	3" Tri-seal tank ball	1/100

* The manufacturers' names are used only to describe whose products the products will fit.

B

American Standard* Seat Disc Tank Ball



C04024



T02025

- For small tilt flush valves
- Units are in a plastic housing to protect the shape of the seats
- CARTON QUANTITIES ONLY

PART NO.	DESCRIPTION	CTN/MSTR
C04024	Screw-on unit black	1/25
C04025	Snap-on unit black	1/25
T02025	Combo seat disc, snap-on and screw-on	1/25

* The manufacturers' names are used only to describe whose products the products will fit.

Float Ball



- Fits 1/4" rod
- Made of high density poly
- CARTON QUANTITIES ONLY ON THE C05041

PART NO.	DESCRIPTION	CTN/MSTR
C05040	Plastic 4" x 5"	1/24
C05041	Copper 4" x 5"	12/72

Flappers



C04005



C04006



C04007



C04008



C04010



C04011

- High grade vinyl construction
- New boxing to protect shape of units

PART NO.	DESCRIPTION	CTN/MSTR
C04005	3 way with strap (fits plastic, brass and old Crane* 57 flush valves)	25/100
C04006	3 way with stainless chain and strap (fits plastic, brass and old Crane* 57 flush valves)	25/100
C04007	Standard unit with 9" chain and strap	1/10
C04008	Kohler* unit with 8" chain	50/200
C04010	Crane* unit with 9" chain	50/200
C04011	Eljer* original unit with rigid arms and foam cone with beaded chain	1/10

* The manufacturers' names are used only to describe whose products the products will fit.

Kohler* Rialto™ Flapper



C04028



C04029



- 5 year warranty
- Blister carded for easy display
- Made from high grade chlorazone
- Resists chemicals and toilet tank cleaners

PART NO.	DESCRIPTION	FITS KOHLER* MODELS	CTN/MSTR
C04028	Kohler Flapper 2010 BP	Rialto, San Raphael, Santa Martine and Rosario	12/72
C04029	Sharkfin Flapper 2012 BP	Rialto, San Raphael, Santa Rosa, Revival and Gabrielle	12/72

* The manufacturers' names are used only to describe whose products the products will fit.

2 Way Flapper with Separate Trunion



- Siliconized chemical resistant material
- Stainless steel chain

PART NO.	DESCRIPTION	CTN/MSTR
C04002	2 way flapper	1/10

Carded Blue Vinyl Flapper



- 5 year warranty on flapper life
- Chemical resistant
- Individually carded
- Soft body replacement flapper
- 9" stainless steel chain and hook

PART NO.	DESCRIPTION	CTN/MSTR
C04004	Carded blue fit-all vinyl flapper	25/100

Jumbo ToTo* Style Flapper



PART NO.	DESCRIPTION	CTN/MSTR
C04000	Blue flapper (Power Gravity)	1/10
C04001	Red flapper (G-Max)	1/10

* The manufacturers' names are used only to describe whose products the products will fit.

Blue Vinyl Flapper



- 5 year warranty
- Chemical resistant
- Fits most plastic flush valves
- Easily installed- no collar to cut
- 9" stainless steel chain and hook
- CARTON QUANTITIES ONLY



PART NO.	DESCRIPTION	CTN/MSTR
C04014	Blue vinyl flapper	1/80

Red Korky® Plus Flapper



- 5 year warranty
- Chemical resistant
- Individually carded in cartons of 12



PART NO.	DESCRIPTION	CTN/MSTR
C04016	Red Korky® Plus (2001BP)	12/72

Items marked with the Jones Stephens logo are "You Need It... We Got It" Items.

Korky® Plus Ultra Water Saver Flapper



- 5-year manufacturer's warranty
- The most universal 2" flapper
- Adjusts to match OEM performance in all tank sizes including 1.28, 1.6, 3.5 and 5+ gpf toilets
- Adjusts to save water in any tank size
- Korky® red Chorazone® rubber resists chlorine



PART NO.	DESCRIPTION	CTN/MSTR
C04038	Korky® Plus ultra water saver flapper (100BP)	1/12

Korky® Flapper



C04032

- C04032 Fits Kohler®* Class Five™ Flapper
- Larger 3 1/4" replacement flapper
 - Replaces Kohler®* No. 1016546 & 1042313
 - Engineered materials resist chlorine



C04033

- C04033 Fits Eljer®*Titan™ Flapper
- Replaces Eljer®* No. 495-6077-00
 - Engineered materials chlorine



C04034

- C04034 Fits American Standard®* Cadet 3® Flapper
- Replaces American Standard®* No. 738920-0070P
 - Engineered materials resist chlorine

PART NO.	DESCRIPTION	CTN/MSTR
C04032	Fits Kohler®* Class Five™ flapper (3010BP)	1/5
C04033	Fits Eljer®*Titan™ flapper (3030BP)	1/5
C04034	Fits American Standard®* Cadet 3® flapper (3040BP)	1/5

* The manufacturers' names are used only to describe whose products the products will fit.

The Original Korky® Flapper



- No tank centering
- Assures a positive seal
- Easy fingertip operation
- Individually carded cartons
- Eliminates lift wire misalignment
- Chemical resistant in areas with poor water quality



PART NO.	DESCRIPTION	CTN/MSTR
C04015	(54 BP)	12/72
C04017	Fits Kohler®* (58 BP)	10/100

* The manufacturers' names are used only to describe whose products the products will fit.

Korky® Plus 3 Universal Flapper



- 5-year manufacturer's warranty
- Universal design fits large 3" flush valves
- Adjusts to match OEM performance for all 3" flapper-based systems
- Korky® red Chorazone® rubber resists chlorine



PART NO.	DESCRIPTION	CTN/MSTR
C04039	Korky® Plus 3 universal toilet flapper (3060BP)	1/5

Items marked with the Jones Stephens logo are "You Need It...We Got It" Items.

Korky® 1.6 Adjustable Flapper



- Chemical resistant
- Easy to install and adjust
- Individually carded in cartons of 12
- Flush volume changes with just a twist
- Can be used as a water saving device
- Adjustable sealing ball for precise water control
- Universal design fits most popular brands of 1.6 toilets



PART NO.	DESCRIPTION	CTN/MSTR
C04027	Korky® 1.6 adjustable flapper (16BP)	12/72

Korky® Plus Adjustable Flapper



- Adjust flush volume with movable float on chain
- Slide the float up for water savings or down for increased flush volume
- Korky® red Chorazone® rubber resists chlorine



PART NO.	DESCRIPTION	CTN/MSTR
C04013	Korky® Plus adjustable flapper (2004BP)	1/12

Closet Spud



- Cast brass
- Includes spud washer and metal friction ring

PART NO.	DESCRIPTION	CTN/MSTR
C27125	1-1/4" closet spud	25/100
C27150	1-1/2" closet spud	25/100
C27200	2" closet spud	25/75
C27201	2" x 1-1/4" closet spud	25/100
C27202	2" x 1-1/2" closet spud	25/75
C27127	1-1/2" x 1-1/4" closet spud	25/100
C27150A	1-1/2" (For American Standard*) closet spud	25/100

* The manufacturers' names are used only to describe whose products the products will fit.

Urinal Spud



- Cast brass
- Includes spud washer and metal friction ring

PART NO.	DESCRIPTION	CTN/MSTR
C27134	1" x 3/4" urinal spud	25/200
C27126	1-1/4" x 3/4" urinal spud	25/125
C27310	1-1/2" x 3/4" urinal spud	25/100

Closet Spud Washer



- CARTON QUANTITIES ONLY

PART NO.	DESCRIPTION	CTN/MSTR
C27301	1-1/4" closet spud washer	25/500
C27302	1-1/2" closet spud washer	25/500
C27303	2" closet spud washer	25/500
C27304	2" x 1-1/4" closet spud washer	25/500
C27305	2" x 1-1/2" closet spud washer	25/500
C27308	1" x 3/4" closet spud washer	25/1000
C27309	1-1/4" x 3/4" closet spud washer	25/500

Closet Spud Friction Ring



- Zinc plated
- CARTON QUANTITIES ONLY

PART NO.	DESCRIPTION	CTN/MSTR
C27321	1-1/4" friction ring	25/1000
C27322	1-1/2" friction ring	25/1000
C27323	2" friction ring	25/500
C27324	2" x 1-1/4" friction ring	25/500
C27325	2" x 1-1/2" friction ring	25/500
C27328	1" x 3/4" friction ring	25/500

Flush Valve Shank Washer



- 3-1/16" OD x 2-1/4" ID
- Rubber

PART NO.	DESCRIPTION	CTN/MSTR
T02028	3/8" Height flush valve shank washer	1/100

Aqua Seal Washer



- Rubber
- American Standard* Top Hat Washer
- CARTON QUANTITIES ONLY

PART NO.	DESCRIPTION	CTN/MSTR
T85057	Aqua seal washer	1/100

* The manufacturers' names are used only to describe whose products the products will fit.

Beveled Ballcock Shank Washer



- Rubber
- 1 3/4" OD x 15/16" ID

PART NO.	DESCRIPTION	CTN/MSTR
T85056	1/2" beveled ballcock shank washer	1/100

Flat Bibb Washer



- EPDM rubber
- Priced per carton
- 100 pieces per carton

PART NO.	SIZE	TRADE SIZE	OD	CTN/MSTR
O25202	1/4"	00	1/2"	1/100
O25203	1/4"	0	17/32"	1/100
O25204	1/4"	1/4	9/16"	1/100
O25205	1/4"	1/4L	19/32"	1/100
O25206	3/8"	3/8	5/8"	1/100
O25207	3/8"	3/8M	21/32"	1/100
O25208	3/8"	3/8L	11/16"	1/100
O25209	1/2"	1/2	3/4"	1/100
O25210	1/2"	1/2L	25/32"	1/100

Beveled Bibb Washer



- Priced per carton
- 100 pieces per carton
- Rubber

PART NO.	SIZE	TRADE SIZE	OD	CTN/MSTR
O25302	1/4"	00	1/2"	1/100
O25303	1/4"	0	17/32"	1/100
O25304	1/4"	1/4	9/16"	1/100
O25305	1/4"	1/4L	19/32"	1/100
O25306	3/8"	3/8	5/8"	1/100
O25307	3/8"	3/8M	21/32"	1/100
O25308	3/8"	3/8L	11/16"	1/100
O25309	1/2"	1/2	3/4"	1/100
O25310	1/2"	1/2L	25/32"	1/100

Sponge Closet Gaskets



- All have 2 bolt holes
- 5-1/2" center-to-center

G13500

G13534

G13634

PART NO.	OD x ID x THICKNESS	CTN/MSTR
G13534	5-3/8" x 3-1/2" x 3/4"	10/200
G13516	5-3/8" x 3-1/2" x 9/16"	10/232
G13634	6-3/4" x 3-1/2" x 3/4"	10/80
G13601	6-3/4" x 3-1/2" x 1"	10/80
G13616	6-3/4" x 3-1/2" x 9/16"	10/80
G13638	6-3/4" x 3-1/2" x 3/8"	10/80
G13500	4-3/8" x 2-7/8" x 1/2" wall hung urinal	10/225

Brass Lift Wire Guide



- Fit-All
- CARTON QUANTITIES ONLY

C05056

C05057

PART NO.	DESCRIPTION	CTN/MSTR
C05056	Adjustable heavy pattern	25/500
C05057	Standard split ring	25/500

Brass Lift Wire



- CARTON QUANTITIES ONLY

PART NO.	DESCRIPTION	CTN/MSTR
C05045	4 1/2" lower	25/2000
C05046	5" lower	25/2000
C05047	5 1/2" lower	25/2000
C05048	8" upper	25/1000
C05049	9" upper	25/1000

Copper Refill Tube



- 1/2" IPS
- CARTON QUANTITIES ONLY

PART NO.	DESCRIPTION	CTN/MSTR
C05051	9" refill tube	25/1000

Brass Float Rod



- CARTON QUANTITIES ONLY

PART NO.	DESCRIPTION	CTN/MSTR
C05052	1/4" x 8" float rod	25/500
C05053	1/4" x 10" float rod	25/500
C05054	1/4" x 12" float rod	25/500

Brass Overflow Tube



- 22 gauge

PART NO.	DESCRIPTION	CTN/MSTR
C05042	1" x 1 1/8" x 10" overflow tube	1/200

Mansfield* Style Ballcock



- All brass
- Compound lever

PART NO.	DESCRIPTION	CTN/MSTR
T02075	Brass ballcock	1/50

* The manufacturers' names are used only to describe whose products the products will fit.

Mansfield* Style Ballcock With Float Rod



- Genuine Mansfield ballcock

PART NO.	DESCRIPTION	CTN/MSTR
T03008	Ballcock with float rod #08	1/20

* The manufacturers' names are used only to describe whose products the products will fit.

Mansfield* Flush Valve #210



- Water saver
- 3.5 gal. toilets
- Instant shut-off
- Won't rust or corrode

PART NO.	DESCRIPTION	CTN/MSTR
T02066	Flush valve	1/50

* The manufacturers' names are used only to describe whose products the products will fit.

Douglas Flush Valve



C05070



C05071

- Brass unit includes split guide
- Plastic unit includes flapper tank ball
- Includes locknut, beveled washer
- Bagged

PART NO.	DESCRIPTION	CTN/MSTR
C05070	Plastic with stainless steel chain	1/50
C05071	Brass	1/50

Korky® Universal 3" Valve Seal



- 5-year manufacturer's warranty
- Replacement seals for tower style flush valves
- Fits Kohler® Class Five™ & Class Six™
- Fits American Standard® Champion® 3
- Korky® red Chorazone® rubber resists chlorine



PART NO.	DESCRIPTION	CTN/MSTR
C05085	Korky® universal 3" valve seal	1/5

* The manufacturers' names are used only to describe whose products the products will fit.

Korky® Flush Valve Seal for Champion® 4



- 5-year manufacturer's warranty
- Replaces American Standard® No. 7301111-0070A
- Korky® red Chorazone® rubber resists chlorine



PART NO.	DESCRIPTION	CTN/MSTR
C05086	Korky® flush valve seal for Champion® 4	1/5

* The manufacturers' names are used only to describe whose products the products will fit.

Korky® QuietFill Valve



- 5 year guarantee
- Resists chlorine



PART NO.	DESCRIPTION	CTN/MSTR
C05200	Korky® QuietFill valve (5282)	1/24

Integral Float Fill Valve



- Fits most toilets
- Replace all of the complicated mechanisms with this simple kit
- Adjustable height from 9" to 13"
- Adjustable float for adjustable water height
- Similar to Fluidmaster® 400A

PART NO.	DESCRIPTION	KORKY #	CTN/MSTR
T02070	Integral float fill valve	528Z	1/12

* The manufacturers' names are used only to describe whose products the products will fit.

American Standard* Toilet Repair Parts

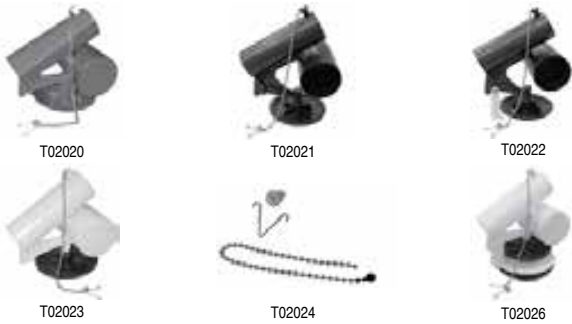

PART NO.	DESCRIPTION	CTN/MSTR
T02020	#5 (33642-07) old style low profile actuator unit, black, with disc, chain, clip and grommet	25/50
T02021	#6 (72880-07) old style high profile actuator unit, complete, black, with disc, chain, clip and grommet	25/50
T02022	#4 (8162-07) old style high profile actuator unit with legs, for one piece low boy*with brass flush valves, complete, black with disc, chain, clip, grommet and legs	25/50
T02023	#4 (70711-07) old style Cadet* water saver actuator unit, white with blue cap complete with disc, chain, clip and grommet	50/100
T02024	Chain kit complete for all actuator units (American Standard* 8321-07) 8" chain	50/500
T02026	#4 (47107-07) new style complete flush valve unit, white, short actuator	1/5
T02027	#5 (47089-07) complete flush valve tall black for standard two-piece closets	50/100

* The manufacturers' names are used only to describe whose products the products will fit.

Ballcock Repair Parts for American Standard*



PART NO.	DESCRIPTION	CTN/MSTR
T02035	7307 cap and plunger with seat, new style	1/10
T02036	N3010 ballcock plunger with thumb hole	1/10

* The manufacturers' names are used only to describe whose products the products will fit.

Ballcock Repair Parts for Coast*



PART NO.	DESCRIPTION	CTN/MSTR
T02037	Coast 1B1*, 1B1P*, standard large head kit with 3 screws	1/10
T02038	Coast 1B1A*, smaller head kit with 3 screws	1/10
T02039	Coast 1B1X*, Kohler*, UR*, Eljer*, Briggs*, American Standard*, kits with 3 screws, high and low boy	1/10

* The manufacturers' names are used only to describe whose products the products will fit.

Ballcock Repair Parts for Amerline*/Hoov-R-Line*



PART NO.	DESCRIPTION	CTN/MSTR
T02050	Standard kit with 4 screws	1/25

* The manufacturers' names are used only to describe whose products the products will fit.

Ballcock Repair Parts for Kohler*



PART NO.	DESCRIPTION	CTN/MSTR
T02051	Black plunger with cap and seal	1/10

* The manufacturers' names are used only to describe whose products the products will fit.

Ballcock Repair Parts for Fluidmaster*



PART NO.	DESCRIPTION	CTN/MSTR
T02052	Diaphragm N/S heavy duty white for hard water and chloramines (Ref. 242F)	1/10
T02053	Standard black diaphragm (Ref. 242)	1/10

* The manufacturers' names are used only to describe whose products the products will fit.

Mansfield* Ballcock and Flush Valve Repair Parts



* Original Mansfield* parts

PART NO.	DESCRIPTION	CTN/MSTR
T02062	08 ballcock repair kit	1/10
T02064	208/209 flush valve diaphragm	10/50
T02065	210/211 flush valve seal	10/700

* The manufacturers' names are used only to describe whose products the products will fit.

Dual Flush Toilet Kit



- Simple to install
- Save water with every flush!
- Push one way to rinse liquid
- Push the other way to flush solids

PART NO.	DESCRIPTION	CTN/MSTR
T02067	Dual flush toilet kit	1/40

Toilet Tank Cover



- Fit-All
- White plastic
- Fits most tanks with outside dimensions of 21-1/8" x 7-3/8" or less

PART NO.	DESCRIPTION	CTN/MSTR
T02005	White	1/1

Enduro Closet Bolt



- Never Rusts
- Space age material
- Fits all closet flange styles
- Withstands over 1,000 PSI
- CARTON QUANTITIES ONLY

PART NO.	DESCRIPTION	CTN/MSTR
C02050	5/16" x 2-1/2" closet bolt	50 pairs/500 pairs



- 50 pairs per display

PART NO.	DESCRIPTION	CTN/MSTR
CJ1003	5/16" x 2-1/2" closet bolt display	1/1

Flexible and Rigid Super Shims



- Stackable
- Rigid, can be driven
- Flexible, can be trimmed
- Priced per bag
- 10 per bag

MADE IN THE USA

PART NO.	DESCRIPTION	CTN/MSTR
S55950	1-1/8" x 1-15/16" x 1/4" flexible	1 bag of 10/400
S55951	1-1/8" x 1-15/16" x 1/4" rigid	1 bag of 10/400



- 200 super shims packaged in a convenient refillable "candy bowl" counter display
- Priced per display

PART NO.	DESCRIPTION	CTN/MSTR
S55952	200 Flexible super shims	1/1
S55953	200 Rigid super shims	1/1

Closet Wedge Shims



- Stackable
- 3/8" width x 1-3/8" length x 5/16" height
- Easily trimmed to desired height
- Priced per bag

MADE IN THE USA

PART NO.	DESCRIPTION	CTN/MSTR
S55902	100 shims poly bagged	1/1



- Priced per display

PART NO.	DESCRIPTION	CTN/MSTR
S55903	1000 shims counter display	1/1

Items marked with the Jones Stephens logo are "You Need It...We Got It" Items.

"Bucket Of Bolts"



- Attractive counter/shelf display
- Closet bolts are custom packed (2 bolts, nuts, and washers per bag)

Brass Plated Bolts, Zinc Plated Washers and Zinc Plated Acorn Nuts

PART NO.	SIZE	WASHER	CTN/MSTR
CB2001	1/4" x 2-1/4"	Oval	50 pairs/1
CB2011	1/4" x 2-1/4"	Round	50 pairs/1
CB2002	1/4" x 3-1/2"	Oval	50 pairs/1
CB2012	1/4" x 3-1/2"	Round	50 pairs/1
CB2003	5/16" x 1-3/4"	Oval	50 pairs/1
CB2013	5/16" x 1-3/4"	Round	50 pairs/1
CB2004	5/16" x 2-1/4"	Oval	50 pairs/1
CB2014	5/16" x 2-1/4"	Round	50 pairs/1
CB2005	5/16" x 3-1/2"	Oval	50 pairs/1
CB2015	5/16" x 3-1/2"	Round	50 pairs/1

Brass Bolts, Stainless Washers and Nickel Plated Acorn Nuts

PART NO.	SIZE	WASHER	CTN/MSTR
CB2021	1/4" x 2-1/4"	Oval	50 pairs/1
CB2030	1/4" x 2-1/4"	Round	50 pairs/1
CB2022	1/4" x 3-1/2"	Oval	50 pairs/1
CB2031	1/4" x 3-1/2"	Round	50 pairs/1
CB2023	5/16" x 1-3/4"	Oval	50 pairs/1
CB2032	5/16" x 1-3/4"	Round	50 pairs/1
CB2024	5/16" x 2-1/4"	Oval	50 pairs/1
CB2033	5/16" x 2-1/4"	Round	50 pairs/1
CB2025	5/16" x 3-1/2"	Oval	50 pairs/1
CB2034	5/16" x 3-1/2"	Round	50 pairs/1

Closet Bolts with Tinnerman Nuts



- Two each bolts, nuts, round washers and tinnerman nuts per bag
- CARTON QUANTITIES ONLY

Brass Plated Bolts, Zinc Plated Washers and Zinc Plated Tinnerman Nuts

PART NO.	SIZE	CTN/MSTR
C02401	1/4" x 2-1/4"	50 pairs/400
C02402	1/4" x 3-1/2"	50 pairs/200
C02403	5/16" x 1-3/4"	50 pairs/200
C02404	5/16" x 2-1/4"	50 pairs/200
C02405	5/16" x 3-1/2"	50 pairs/200

Brass Bolts, Stainless Washers and Nickel Plated Tinnerman Nuts

PART NO.	SIZE	CTN/MSTR
C02421	1/4" x 2-1/4"	50 pairs/400
C02990	1/4" x 3-1/2"	50 pairs/200
C02422	5/16" x 1-3/4"	50 pairs/400
C02423	5/16" x 2-1/4"	50 pairs/400
C02424	5/16" x 3-1/2"	50 pairs/200

B

Closet Bolts



- Closet bolts are custom packed (2 bolts, nuts, and washers per bag)
- CARTON QUANTITIES ONLY

Brass Plated Bolts, Zinc Plated Washers and Zinc Plated Acorn Nuts

PART NO.	SIZE	WASHER	CTN/MSTR
C02000	1/4" x 1-3/4"	Oval	50 pairs/400
C02010	1/4" x 1-3/4"	Round	50 pairs/400
C02001	1/4" x 2-1/4"	Oval	50 pairs/400
C02011 	1/4" x 2-1/4"	Round	50 pairs/400
C02002	1/4" x 3-1/2"	Oval	50 pairs/400
C02012	1/4" x 3-1/2"	Round	50 pairs/200
C02003	5/16" x 1-3/4"	Oval	50 pairs/400
C02013	5/16" x 1-3/4"	Round	50 pairs/400
C02004	5/16" x 2-1/4"	Oval	50 pairs/200
C02014	5/16" x 2-1/4"	Round	50 pairs/200
C02005	5/16" x 3-1/2"	Oval	50 pairs/200
C02015	5/16" x 3-1/2"	Round	50 pairs/200

Brass Bolts, Stainless Washers, Nickel Plated Acorn Nuts

PART NO.	SIZE	WASHER	CTN/MSTR
C02020	1/4" x 1-3/4"	Oval	50 pairs/400
C02029	1/4" x 1-3/4"	Round	50 pairs/200
C02021	1/4" x 2-1/4"	Oval	50 pairs/400
C02030	1/4" x 2-1/4"	Round	50 pairs/400
C02022	1/4" x 3-1/2"	Oval	50 pairs/200
C02031	1/4" x 3-1/2"	Round	50 pairs/200
C02023	5/16" x 1-3/4"	Oval	50 pairs/200
C02032	5/16" x 1-3/4"	Round	50 pairs/200
C02024	5/16" x 2-1/4"	Oval	50 pairs/200
C02033	5/16" x 2-1/4"	Round	50 pairs/200
C02025	5/16" x 3-1/2"	Oval	50 pairs/200
C02034	5/16" x 3-1/2"	Round	50 pairs/200

Closet Bolts



- Bulk Packed - One each bolt, nut, washer and acorn nut per bag
- CARTON QUANTITIES ONLY

Brass Plated Bolts, Zinc Plated Washers and Zinc Plated Acorn Nuts

PART NO.	SIZE	WASHER	CTN/MSTR
C02000B	1/4" x 1-3/4"	Oval	100 each/400
C02010B	1/4" x 1-3/4"	Round	100 each/400
C02001B	1/4" x 2-1/4"	Oval	100 each/400
C02011B	1/4" x 2-1/4"	Round	100 each/400
C02002B	1/4" x 3-1/2"	Oval	100 each/400
C02012B	1/4" x 3-1/2"	Round	100 each/400
C02003B	5/16" x 1-3/4"	Oval	100 each/400
C02004B	5/16" x 2-1/4"	Oval	100 each/400
C02014B	5/16" x 2-1/4"	Round	100 each/400
C02005B	5/16" x 3-1/2"	Oval	100 each/400
C02015B	5/16" x 3-1/2"	Round	100 each/400

Brass Bolts, Stainless Washers and Nickel Plated Acorn Nuts

PART NO.	SIZE	WASHER	CTN/MSTR
C02020B	1/4" x 1-3/4"	Oval	100 each/400
C02029B	1/4" x 1-3/4"	Round	100 each/400
C02021B	1/4" x 2-1/4"	Oval	100 each/400
C02030B	1/4" x 2-1/4"	Round	100 each/400
C02022B	1/4" x 3-1/2"	Oval	100 each/400
C02031B	1/4" x 3-1/2"	Round	100 each/400
C02023B	5/16" x 1-3/4"	Oval	100 each/400
C02032B	5/16" x 1-3/4"	Round	100 each/400
C02024B	5/16" x 2-1/4"	Oval	100 each/400
C02033B	5/16" x 2-1/4"	Round	100 each/400
C02025B	5/16" x 3-1/2"	Oval	100 each/400
C02034B	5/16" x 3-1/2"	Round	100 each/400

 Items marked with the Jones Stephens logo are "You Need It... We Got It" Items.

Closest Bolt Component Parts



Closest Bolt



Closest Screw



Tinnerman Nut

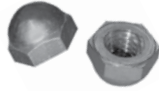

Closed Acorn Nut



Open Acorn Nut



Oval Washer



Round Washer

PART NO.	DESCRIPTION	CTN/MSTR
C02800	1/4" x 1-3/4" brass plated closet bolt	100/1200
C02801	1/4" x 2-1/4" brass plated closet bolt	100/1200
C02802	1/4" x 3-1/2" brass plated closet bolt	100/700
C02803	5/16" x 1-3/4" brass plated closet bolt	100/700
C02804	5/16" x 2-1/4" brass plated closet bolt	100/800
C02805	5/16" x 3-1/2" brass plated closet bolt	100/500
C02820	1/4" x 1-3/4" brass closet bolt	100/1500
C02821	1/4" x 2-1/4" brass closet bolt	100/1200
C02822	1/4" x 3-1/2" brass closet bolt	100/700
C02823	5/16" x 1-3/4" brass closet bolt	100/1000
C02824	5/16" x 2-1/4" brass closet bolt	100/800
C02825	5/16" x 3-1/2" brass closet bolt	100/500
C02830	1/4" x 2-1/4" brass snap-off closet bolt	100/1000
C02832	5/16" x 2-1/4" brass snap-off closet bolt	100/800
C02808	1/4" x 2-1/2" brass plated closet screw	100/1000
C02815	1/4" x 3-1/2" brass plated closet screw	100/1000
C02811	5/16" x 2-1/2" brass plated closet screw	100/700
C02812	1/4" x 2-1/2" brass closet screw	100/800
C02813	1/4" x 3-1/2" brass closet screw	100/1000
C02814	5/16" x 2-1/2" brass closet screw	100/1000
C02806	1/4" tinnerman nut	100/3500
C02807	5/16" tinnerman nut	100/3500
C02860	1/4" x 7/16" nickel plated open acorn nut	100/5000
C02861	1/4" x 7/16" zinc plated open acorn nut	100/5000
C02862	5/16" x 9/16" nickel plated open acorn nut	100/3000
C02863	5/16" x 9/16" zinc plated open acorn nut	100/3000
C02809	1/4" x 7/16" zinc plated closed acorn nut	100/2500
C02810	5/16" x 9/16" zinc plated closed acorn nut	100/4000
C02900	1/4" nickel plated closed acorn nut	100/2500
C02901	5/16" nickel plated closed acorn nut	100/4000
C02864	1/4" brass open acorn nut	100/2500
C02865	5/16" brass open acorn nut	100/4000
C02850	Oval stainless steel washer	100/5000
C02851	Oval zinc plated washer	100/4000
C02852	Round stainless steel washer	100/5000
C02853	Round zinc plated washer	100/5000

Items marked with the Jones Stephens logo are "You Need It... We Got It" Items.

Snap-Off Closet Bolts



- Closet bolts are custom packed (2 bolts, nuts, and washers per bag)
- Available boxed or in counter display ("Bucket of Bolts")

PART NO.	SIZE	WASHER	CTN/MSTR
C02040	1/4" x 2-1/4"	Oval	50 pairs/400
C02045	1/4" x 2-1/4"	Round	50 pairs/400
C02041	5/16" x 2-1/4"	Oval	50 pairs/200
C02046	5/16" x 2-1/4"	Round	50 pairs/200



- Priced per display

PART NO.	SIZE	WASHER	CTN/MSTR
CB2040	1/4" x 2-1/4"	Oval	50 pairs/1
CB2045	1/4" x 2-1/4"	Round	50 pairs/1
CB2041	5/16" x 2-1/4"	Oval	50 pairs/1
CB2046	5/16" x 2-1/4"	Round	50 pairs/1

Closest Bolt - Elite Packs



- CARTON QUANTITIES ONLY

Packed with 4 Acorn Nuts and 4 Round Washers

PART NO.	DESCRIPTION	CTN/MSTR
C02989	5/16" x 1-3/4" brass plated bolts	50 pairs/400
C02999	1/4" x 2-1/4" brass plated bolts	50 pairs/400
C02998	1/4" x 2-1/4" solid brass bolts	50 pairs/400
C02997	1/4" x 3-1/2" brass plated bolts	50 pairs/200
C02996	1/4" x 3-1/2" solid brass bolts	50 pairs/200
C02992	1/4" x 2-1/4" solid brass bolts	50 pairs/400
C02993	5/16" x 2-1/4" brass plated bolts	50 pairs/200

Packed with 2 Acorn Nuts, 2 Hex Nuts, and 4 Round Washers

PART NO.	DESCRIPTION	CTN/MSTR
C02995	1/4" x 2-1/4" brass plated bolts	50 pairs/400
C02994	1/4" x 2-1/4" solid brass bolts	50 pairs/400

Packed with 2 Acorn Nuts, 2 Hex Nuts, 4 Round Washers, and 2 Tinnerman Nuts

PART NO.	DESCRIPTION	CTN/MSTR
C02987	1/4" x 2-1/4" solid brass bolts	50 pairs/400

Closest Bolt Cap



Oval Cap

Round Cap

- Plastic
- CARTON QUANTITIES ONLY

Bulk Packed - Priced Per Cap and Washer

PART NO.	DESCRIPTION	CTN/MSTR
C02100	Oval white (less washer)	100/900
C02105	Round white (with washer)	100/2000
C02106	Round bone (with washer)	100/4000

Custom Packed - Priced Per Bag of Two Each

PART NO.	DESCRIPTION	CTN/MSTR
C02103	Round white (with washer)	50 pairs/50
C02104	Round bone (with washer)	50 pairs/50

B

Closet Screws



- Two each screws, nuts, and washers per bag
- CARTON QUANTITIES ONLY

With Round Washer

With Oval Washer

Brass Plated Bolts, Stainless Washers and Nickel Plated Acorn Nuts

PART NO.	SIZE	WASHER	CTN/MSTR
C02200	1/4" x 2-1/2"	Oval	50 pairs/200
C02210	1/4" x 2-1/2"	Round	50 pairs/400
C02203	1/4" x 3-1/2"	Oval	50 pairs/200
C02202	1/4" x 3-1/2"	Round	50 pairs/200
C02211	5/16" x 2-1/2"	Oval	50 pairs/200
C02201	5/16" x 2-1/2"	Round	50 pairs/200

Brass Bolts, Stainless Washers and Nickel Plated Acorn Nuts

PART NO.	SIZE	WASHER	CTN/MSTR
C02300	1/4" x 2-1/2"	Oval	50 pairs/400
C02310	1/4" x 2-1/2"	Round	50 pairs/400
C02303	1/4" x 3-1/2"	Oval	50 pairs/200
C02302	1/4" x 3-1/2"	Round	50 pairs/400
C02311	5/16" x 2-1/2"	Oval	50 pairs/200
C02301	5/16" x 2-1/2"	Round	50 pairs/200

Tank to Bowl Set



- Universal fit sponge rubber gasket
- Domed poly wingnut fits into china, eliminating bottom washer
- CARTON QUANTITIES ONLY

PART NO.	DESCRIPTION	BOLT	CTN/MSTR
C03250	5/16" x 3"	Brass Plated	25 pairs/1
C03251	5/16" x 3" with gasket	Brass Plated	25 pairs/1
C03252	5/16" x 3"	Brass	25 pairs/1
C03253	5/16" x 3" with gasket	Brass	25 pairs/1

Tank to Bowl Bolt Set



- Universal fit sponge rubber gasket
- CARTON QUANTITIES ONLY

With Wing Nut

PART NO.	DESCRIPTION	BOLT	CTN/MSTR
C03200	5/16" x 3"	Brass Plated	50 pairs/200
C03201	5/16" x 3" with gasket	Brass Plated	25 pairs/200
C03202	5/16" x 3"	Brass	50 pairs/200
C03203	5/16" x 3" with gasket	Brass	25 pairs/200

With Hex Nut

PART NO.	DESCRIPTION	BOLT	CTN/MSTR
C03210	5/16" x 3"	Brass Plated	50 pairs/200
C03211	5/16" x 3" with gasket	Brass Plated	25 pairs/200
C03212	5/16" x 3"	Brass	50 pairs/200
C03213	5/16" x 3" with gasket	Brass	25 pairs/100

With Hex Nut and Wing Nut

PART NO.	DESCRIPTION	BOLT	CTN/MSTR
C03240	5/16" x 3"	Brass	50 pairs/100

Tank to Bowl Bolt Kit for Mansfield*



- Includes 3 brass plated bolts, 3 hex nuts, 3 round washers, 1 sponge rubber gasket, 1 ballcock coupling nut and 3 cloth inserted washers
- 3" bolt

PART NO.	DESCRIPTION	CTN/MSTR
C03260	Mansfield* kit	1/25

* The manufacturers' names are used only to describe whose products the products will fit.

Tank to Bowl Bolt Kit for Gerber*



- Includes 2 brass bolts, 2 hex nuts, 4 round washers, 1 sponge rubber gasket and 4 cloth inserted washers

PART NO.	DESCRIPTION	CTN/MSTR
C03265	Gerber* kit	1/25

* The manufacturers' names are used only to describe whose products the products will fit.

Tank to Bowl Bolt Kit for American Standard*



- Includes 2 bolts, 4 nuts, 4 round washers and 1 sponge rubber gasket

PART NO.	DESCRIPTION	CTN/MSTR
C03270	American Standard* kit (brass plated bolts)	1/25
C03271	American Standard* kit (brass bolts)	1/25

* The manufacturers' names are used only to describe whose products the products will fit.

Tri-Tank to Bowl Bolt Kit for American Standard*



- Includes 3 brass plated bolts, 6 hex nuts, 6 round washers, 1 sponge rubber gasket and 6 cloth inserted washers

PART NO.	DESCRIPTION	CTN/MSTR
C03272	American Standard* tank to bowl bolt kit	1/25

* The manufacturers' names are used only to describe whose products the products will fit.

Tri-Bolt Tank to Bowl Bolt Set



- For units requiring 3-bolt attachment
- Custom packed with 3 brass bolts, 6 round washers, 6 hex nuts and 6 cloth inserted washers

PART NO.	DESCRIPTION	CTN/MSTR
C03280	5/16" x 3"	1/25

Offset Tank to Bowl Bolts



- All brass
- Rubber washers
- 2" maximum adjustment

PART NO.	DESCRIPTION	CTN/MSTR
C02075	Offset tank to bowl bolts	50/200

Items marked with the Jones Stephens logo are "You Need It... We Got It" Items.

Tank to Bowl Components



PART NO.	DESCRIPTION	CTN/MSTR
C03800	5/16"-18 x 3" brass plated tank bolt	100/500
C03801	5/16"-18 x 3" brass tank bolt	100/500
C03803	5/16"-18 brass plated forged wing nut	100/500
C03804	5/16"-18 brass plated heavy hex jam nut	100/5500
C03805	5/16"-18 brass heavy hex jam nut	100/5000
C03807	5/16" acetal tank bowl wing nut	100/3500
C03810	Cloth inserted washer	10/100
C02852	Stainless steel washer	100/5000

Tank to Bowl Gaskets



- Close coupled tank to bowl gaskets
- Beveled sponge rubber material
- CARTON QUANTITIES ONLY

Universal Fit-All

PART NO.	DESCRIPTION	CTN/MSTR
C03300	2-1/4" ID x 3-3/8" OD x 11/16" thick	25/1000

Kohler* (fits Alamo and other Kohler* integral units with two piece closets)

PART NO.	DESCRIPTION	CTN/MSTR
C03301	2-1/2" ID x 3-3/4" OD x 3/4" thick	25/1000

Eljer* (rubber)

PART NO.	DESCRIPTION	CTN/MSTR
C03302	2-5/16" ID x 3-1/8" OD x 3/8" thick	25/1000

American Standard Cadet*, Kohler*, Crane*, Borg Warner*

PART NO.	DESCRIPTION	CTN/MSTR
C03303	2-1/8" ID x 3-1/2" OD x 1-1/4" thick	25/300

Crane*

PART NO.	DESCRIPTION	CTN/MSTR
C03304	2-1/8" ID x 3-1/4" OD x 1-1/16" thick	25/300

Gerber* (free standing late models)

PART NO.	DESCRIPTION	CTN/MSTR
C03305	2-1/8" ID x 3-1/4" OD x 1-3/16" thick	25/300

Mansfield*

PART NO.	DESCRIPTION	CTN/MSTR
C03306	2-1/2" ID x 3-5/8" OD x 3/4" thick	25/200

* The manufacturers' names are used only to describe whose products the products will fit.

Wax Gaskets



- Boxed
- CARTON QUANTITIES ONLY

PART NO.	DESCRIPTION	CTN/MSTR
G13001	Full size standard wax gasket	1/48
G13002	Gasket with plastic flange	1/24
G13003	Urinal gasket- fits 2" outlet	1/12
G13004	Jumbo wax gasket	1/12

Radiant Seal Sponge Rubber Closet Gasket



- Neoprene
- Easy installation
- Unaffected by radiant heat
- Seals effectively with uneven floors

PART NO.	DESCRIPTION	CTN/MSTR
G13005	3-3/4" ID x 5-1/8" OD x 1/2" thick	1/150

Closet Bend Spacer



- Fit-all
- Eliminates the need to chip out concrete
- 6" OD x 4" high (fits 3" and 4" waste lines)
- Keeps poured concrete away from waste lines and closet bends
- Replaces styrofoam, styrene coverings, coffee cans and duct tape
- Outside is plastic, inside is foam
- CARTON QUANTITIES ONLY

PART NO.	DESCRIPTION	CTN/MSTR
S12005	Closet bend spacer	18/18

Styrofoam Closet Flange Spacer



- Eliminates needless chipping of concrete
- Styrofoam breaks away or melts with flame
- CARTON QUANTITIES ONLY

PART NO.	DESCRIPTION	CTN/MSTR
S13130	3" Flange spacer	120/120
S13140	4" Flange spacer	120/120

Foam Spacer



- Foam closet bend protector
- CARTON QUANTITIES ONLY

PART NO.	DESCRIPTION	CTN/MSTR
S13240	4"x 4" foam spacer	60/60

B

Shower Rod Flanges



- Flanges fit 15/16" and 1" OD rod
- Mount to wall

PART NO.	DESCRIPTION	CTN/MSTR
S02150	Jiffy flange chrome plated plastic	1/200
S02151	Jiffy flange chrome die cast zinc	1/100
S02152	Chrome flanges with screws (bagged)	50/500

Jumbo Shower Bar Flange



PART NO.	DESCRIPTION	CTN/MSTR
S02300	Jumbo shower bar flange	1/50

Contoured Shower Rod

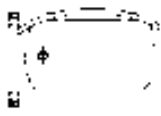

- Brings shower curtain in front of wall to prevent gaps and leaks
- Perfect for 60° oval or standard tubs
- Adjusts easily with tube cutter for shorter walls
- Sweeping curve increases space in center of oval tubs
- Sturdy alloy rods with zinc angled mounting brackets
- Multiple applications - residential, hotel, motel, assisted living, etc.

PART NO.	DESCRIPTION	CTN/MSTR
S02190	Chrome Plated	1/12
S02193	Satin Nickel	1/6

Flanges

PART NO.	FINISH	CTN/MSTR
S02290	Chrome flanges (Fits S02190)	1/1
S02293	Satin Nickel flanges (Fits S02193)	1/1



- Easy installation
- Anchors included
- Brings shower curtain in front of wall to prevent gaps and leaks

PART NO.	FINISH	CTN/MSTR
S02197	Chrome Plated	1/1
S02198	Brushed Nickel	1/2

Aluminum Shower Rod



- 1" OD - .025 wall (22 gauge)
- Individually wrapped
- Can be cut
- CARTON QUANTITIES ONLY

PART NO.	DESCRIPTION	CTN QTY
S02055	5' rod	1/50
S02015	5' rod	1/10
S02056	6' rod	1/50
S02016	6' rod	1/10

Aluminum Shower Rod with Holders



- 1" OD - .025 wall (22 gauge)
- Individually wrapped rods and holders boxed together
- CARTON QUANTITIES ONLY

PART NO.	DESCRIPTION	CTN QTY
S02057	5' rod with plastic Jiffy flange	1/50
S02058	5' rod with die cast Jiffy flange	1/50
S02059	5' rod with chrome flange and screws	1/50
S02071	5' rod with chrome flange and screws (10 pack)	1/10
S02072	6' rod with chrome flange and screws (10 pack)	1/10
S02073	5' rod with plastic Jiffy flange (10 pack)	1/10
S02074	6' rod with plastic Jiffy flange (10 pack)	1/10

Adjustable Aluminum Shower Rod



- Sturdy, self-supporting rod with plastic ends
- 1" OD/.025 wall (22 gauge)
- Expandable from 58" to 61" or 69" to 73"
- Individually wrapped
- CARTON QUANTITIES ONLY

PART NO.	DESCRIPTION	CTN QTY
S02070	Adjustable shower rod 58" - 61"	1/50
S02066	Adjustable shower rod 69" - 73"	1/50
S02069	Adjustable shower rod 58" - 61" (10 pack)	1/10

Deluxe Shower Head



- Chrome plated die cast zinc
- 2.5 gpm flow rate
- Brass ball

PART NO.	DESCRIPTION	CTN/MSTR
S01004	Chrome plated deluxe shower head	1/100

Shower Heads



Plastic



Die cast



Brass

- 2.5 gpm flow rate

Plastic

PART NO.	DESCRIPTION	CTN/MSTR
S01001	2" Chrome with plastic ball	1/100
S01002	2" White with plastic ball	1/200
S01003	2" Chrome with brass ball	1/100

Die Cast

PART NO.	DESCRIPTION	CTN/MSTR
S01005	2" Chrome- adjustable	1/100

Brass

PART NO.	DESCRIPTION	CTN/MSTR
S01008	1-3/4" Chrome- adjustable	1/50
S01009	2-1/8" Chrome- adjustable	1/50
S01010	3" Chrome- adjustable	1/20

Items marked with the Jones Stephens logo are "You Need It...We Got It" Items.

Brass Aerating Water Saver Shower Head



Chrome

Chrome with Shutoff

- Permanent built-in water restrictor
- Mixes air and water for invigorating spray
- Restricts water to 2-2.5 gpm, depending on water pressure

PART NO.	DESCRIPTION	CTN/MSTR
S01013	1" Chrome	50/200
S01014	1" Chrome with shutoff	50/200

Vandal Proof Shower Head



- 2.5 gpm flow rate
- Chrome plated plastic
- Brass ball
- Spray adjusts from coarse to fine
- Secures with set screw, hex key included

PART NO.	DESCRIPTION	CTN/MSTR
S01015	Chrome plated plastic shower head	1/100

Adjustable Plastic Shower Head



- Chrome plated plastic
- 1.5 gpm flow rate
- Brass ball

PART NO.	DESCRIPTION	CTN/MSTR
S01016	Chrome plated adjustable plastic shower head	1/100

Adjustable Massage Shower Head



- Chrome plated plastic
- 2.5 gpm flow rate
- Brass ball

PART NO.	DESCRIPTION	CTN/MSTR
S01020	Chrome plated adjustable massage plastic shower head	1/100

Octagonal Shower Head



- 2.5 gpm flow rate
- Brass ball

PART NO.	DESCRIPTION	CTN/MSTR
S01025	Chrome plated octagonal shower head	10/50

Shower Arms and Kits



Shower Arm

Shower Arm with Flange

"S" Style Shower Arm

- Chrome plated stainless steel arms

PART NO.	DESCRIPTION	CTN/MSTR
S01030	6" Arm only	1/200
S01032	8" Arm only	1/100
S01044	6" Arm and stainless steel flange	1/25
S01045	8" Arm and stainless steel flange	1/100
S01035	8" "S" shaped arm	10/80
S01038	10" "S" shaped arm	25/50

Heavy Adjustable Shower Arm



- Chrome plated brass
- 10" length
- Locking wing nut adjustment

PART NO.	DESCRIPTION	CTN/MSTR
S01039	1/2" x 10" adjustable	10/50

Shower Arm and Flange with Set Screw



- 1/2" x 6" shower arm

PART NO.	DESCRIPTION	CTN/MSTR
S01042	6" Shower arm and flange with set screw	1/25

Plastic Shower Arm



- 1/2" x 6" chrome-plated plastic with flange

PART NO.	DESCRIPTION	CTN/MSTR
S01049	Plastic shower arm and flange	1/200

Shower Arm Flange



S01041

S01040

PART NO.	DESCRIPTION	CTN/MSTR
S01040	Chrome flange with set screw (2-1/2" OD)	40/400
S01041	Stainless steel flange (2-1/2" OD)	50/2000

Shower Curtain Pin



- CARTON QUANTITY ONLY

PART NO.	DESCRIPTION	CTN/MSTR
S02100	Shower curtain pin	500/2000

Shower Pan Liner



- 40 mil thickness flexible gray PVC
- Meets ASTM D4551
- UPC listed
- PVC
- Marked in 6 inch increments for easy measurements
- Treated to prevent the growth of fungus, molds and mildew
- FREIGHT LINE ONLY



PART NO.	DESCRIPTION	CTN/MSTR
S994050	4' x 50' shower pan liner	1/1
S995040	5' x 40' shower pan liner	1/1
S996050	6' x 50' shower pan liner	1/1
S996080	5' x 80' shower pan liner	1/1

PVC Shower Pan Liner Cement



- 3 year shelf life
- Not for PE liner use
- Instant contact strength
- CARTON QUANTITY ONLY

PART NO.	DESCRIPTION	CTN/MSTR
S99100	Shower pan liner cement (pint)	12/12

Water Volume Control



- 1/2" female x 1/2" male IPS
- Allows reduced water flow (does not shut water completely off)

PART NO.	DESCRIPTION	CTN/MSTR
S01060	Chrome-brass	50/200
S01061	Chrome-plastic	1/500

B

Plastic Flow Restrictor



- 2.5 GPM
- Fits most heads

PART NO.	DESCRIPTION	CTN/MSTR
S10080	Shower head flow restrictor	1/1000

54" D-Style Add-A-Shower



- Heavy duty jumbo flanges
- 61" riser with shower head
- Standard bathcock (3 3/8" centers)
- 54" x 27" chrome plated aluminum shower rod (1" diameter)
- Non-adjustable

PART NO.	DESCRIPTION	CTN/MSTR
S10083	54" x 27" D-Style Add-A-Shower	1/5

Add-A-Shower Complete Unit



- Bathcock with diverter spout
- Chrome plated plastic shower head
- 61" rise with 10" rod and riser support
- 24" x 42" rectangular aluminum shower rod with 36" ceiling rod and support

PART NO.	DESCRIPTION	CTN/MSTR
S10070	Complete unit with S10080 diverter	1/5
S10069	Complete unit with S10074 diverter	1/5

Complete Add-A-Shower

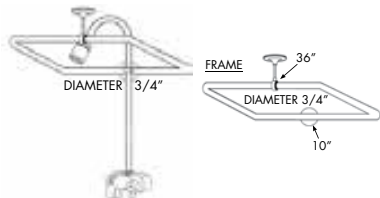

- Rectangular frame
- Aluminum shower rod
- Bathcock with diverter spout
- 3/8" mounting brackets included
- 61" riser with 10" rod and riser support

PART NO.	DESCRIPTION	CTN/MSTR
S10068	24" x 42" Frame only	1/5

Add-A-Shower less Oval Shower Rod



- 61" riser and wall support
- Bathcock with diverter spout
- Chrome plated plastic shower head
- Includes bushings (P11986)

PART NO.	DESCRIPTION	CTN/MSTR
S10072	Complete unit	1/10

Add-A-Shower Diverter Spout and Riser

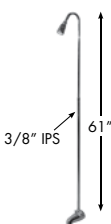

- Diverter valve
- 61" riser with wall support
- Chrome plated plastic shower head
- Includes 1" wall bracket (S10077)
- S10081 replacement diverter

PART NO.	DESCRIPTION	CTN/MSTR
S10071	Spout and riser	1/10

Add-A-Shower Code Pattern



PART NO.	DESCRIPTION	CTN/MSTR
S10074	Code pattern anti-syphon diverter bathcock	1/12

Add-A-Shower Accessories

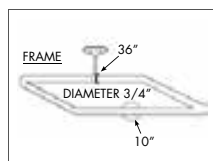

PART NO.	DESCRIPTION	CTN/MSTR
S10075	24" x 42" rectangle shower rod	1/10
B60001	Wall bracket and rod holder with 12" rod (can be cut to fit)	1/100
B60002	Ceiling bracket and rod holder with standard size 36" rod	1/100
S10073	48" ceiling rod only	1
S10080	Replacement bathcock assembly	1/12
S10081	Diverter spout only for S10071 (base connection)	1/50
S10077	Wall bracket for S10071	1/200
S10078	Diverter spout with 65" riser	1/10
S10082	61" CP brass riser only	1/20
S10076	61" CP brass riser with shower head	1/10

Shower Diverter Valve



- Installs between arm and shower head
- Allows usage of hand-held personal shower or shower head

PART NO.	DESCRIPTION	CTN/MSTR
S01070	Chrome push button- brass	1/5

Offset Bath Supplies



B49020

B49021

- Chrome plated
- 1/2" supply tubes
- All hardware needed for connection included

PART NO.	DESCRIPTION	CTN/MSTR
B49020	Single offset (pair)	1/25
B49021	Double offset (pair)	1/25
B49022	Replacement nuts, washers and escutcheons	1/25

Utility Shower

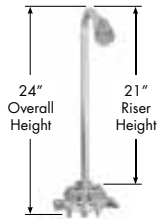

- 21" galvanized riser
- Top or bottom connection
- Chrome plated brass body with shower head and soap dish
- Combination 1/2" threaded or sweat connection union inlets on 3" centers
- Use S10080 for replacement bathcock assembly

PART NO.	DESCRIPTION	CTN/MSTR
S10079	Utility shower	1/6

Bathcocks for Clawfoot Tubs



B49001



B49002



B49010

- Chrome plated brass body
- Replaceable stem and seat
- 3 3/8" centers and 3/4" threaded inlets

PART NO.	DESCRIPTION	CTN/MSTR
B49001	"O" pattern with slip-on spout	1/48
B49002	Code pattern with goose neck spout	1/48
B49010	Coupling elbows (pair) chrome plated 3/4" bath-cock threads x 1/2" male IPS	6/60
B49011	Code spout only	10/300
B49012	Hot repair kit (handle, stem and seat)	1/100
B49013	Cold repair kit (handle, stem and seat)	1/100

Brass Trap Bushing



- Heavy pattern/cast
- 1-1/2" sweat x 1-1/2" IPS
- Knurled end for ease of tightening
- 3/4" length

PART NO.	DESCRIPTION	CTN/MSTR
B55150	1-1/2" SWT x 1-1/2" MIP	1/250

Twin Elbow and Face Bushings



FIP x FIP



MIP x FIP

- Brass

PART NO.	DESCRIPTION	CTN/MSTR
D01040	3/4" FIP x 1/2" FIP twin elbow	1/144
D01041	3/4" MIP x 1/2" FIP face bushing	1/1000
D01042	1/2" MIP x 3/8" FIP face bushing	1/40

Brass Shower Elbow for Fiberglass Shower Stall



- Outlet 1/2" FIP
- Secures tub spout nipple
- Secures shower arm to stall
- Lock nuts secure ell to fiberglass wall
- Requires 1-1/8" hole through fiberglass wall
- Combination inlet 1/2" female sweat or 1/2" threaded

PART NO.	DESCRIPTION	CTN/MSTR
S01050	Brass elbow	6/144

7" Chrome Plated Diverter Spout



- Longer length for today's larger tubs
- CTS unit comes with hex key

PART NO.	SIZE	CONNECTION	CTN/MSTR
D01024	7"	1/2" FIP Nose	1/50
D01025	7"	1/2" CTS Slide	1/25

Chrome Plated Slip-On Diverter Spout with Polished Brass Knob



- Hex key included
- Polished brass knob
- Standard 5 1/2" diverter spout
- 1/2" CTS slip-on connection with set screw

PART NO.	DESCRIPTION	CTN/MSTR
D01032	Slip-on diverter spout with PB knob	1/50

Chrome Plated Diverter Spouts and Extensions



- Zamak
- D01004 Meets IAPMO and California Energy Commission approval
- Use P11928 replacement bushing
- Boxed

PART NO.	DESCRIPTION	CONNECTION	CTN/MSTR
D01001	1/2" FIP	Nose	1/50
D01004	1/2" CTS Slide with hex key	Base	1/50

B



- Brass plated zamak
- D01002 Meets IAPMO and California Energy Commission approval
- Use P11928 replacement bushing
- Boxed

PART NO.	DESCRIPTION	CONNECTION	CTN/MSTR
D01002	3/4" x 1/2" FIP	Base	1/50
D01003	3/4" x 1/2" FIP	Base	1/50



- All brass
- Chrome plated brass
- 8-1/2" One piece diverter spout
- Boxed

PART NO.	DESCRIPTION	CONNECTION	CTN/MSTR
D01015	3/4" x 1/2" FIP	Base	1/20



- Chrome plated zamak
- Two piece diverter spout
- Boxed

PART NO.	DESCRIPTION	CONNECTION	CTN/MSTR
D01008	8-1/4" two piece	—	1/1
D01009	10-1/8" two piece	—	1/1

Extension Only



- Chrome plated brass

PART NO.	DESCRIPTION	CTN/MSTR
D01030	3" extension only	1/100
D01031	4-3/4" extension only	1/80



- Chrome plated zamak
- Diverter spout for hand held shower

PART NO.	DESCRIPTION	CONNECTION	CTN/MSTR
D01010	3/4" x 1/2" FIP top connection	Base	1/10
D01011	3/4" x 1/2" MIP lower connection	Base	1/50

Tub Spouts

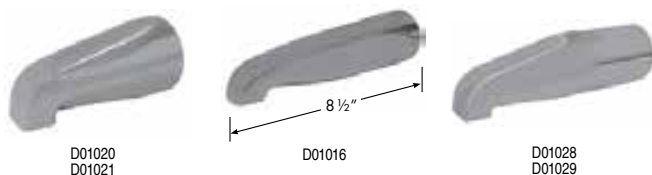

- Chrome plated zamak

Chrome Plated Zamak Slide Connection with Hex Key

PART NO.	DESCRIPTION	CONNECTION	CTN/MSTR
D01020	1/2" FIP	Nose	1/50
D01021	1/2" CTS slide connection	Base	1/50

8 1/2" One Piece Chrome Plated Brass

PART NO.	DESCRIPTION	CONNECTION	CTN/MSTR
D01016	3/4" x 1/2" FIP	Base	1/20

Two Piece Chrome Plated

PART NO.	DESCRIPTION	CONNECTION	CTN/MSTR
D01028	8" two piece	Nose	1/1
D01029	10" two piece	Nose	1/1

Telescoping Tub and Diverter Spout



- 5 1/2" overall length
- Adjustment up to 1" to accommodate various rough-ins

PART NO.	DESCRIPTION	CONNECTION	CTN/MSTR
D01022	1/2" x 3/4" tub spout	Base	1/50
D01023	1/2" x 3/4" diverter spout	Base	1/50

9" Chrome Plated Tub Spout



- Solid brass construction
- One piece design
- 1/2" FIP nose connection

PART NO.	DESCRIPTION	CONNECTION	CTN/MSTR
D01017	9" diverter spout	Base	1/12
D01018	9" tub spout	Base	1/12

7" Chrome Plated Tub Spout



- Longer length for today's larger tubs
- CTS unit comes with hex key

PART NO.	SIZE	CONNECTION	CTN/MSTR
D01026	7"	1/2" FIP Nose	1/50
D01027	7"	1/2" CTS Slide	1/25

Items marked with the Jones Stephens logo are "You Need It...We Got It" Items.

Tub Spouts



Solid Brass

Solid brass

PART NO.	SIZE	CONNECTION	CTN/MSTR
D01005	3/4" x 1/2"	Base	1/40

Overflow Plates



1-Hole



2-Hole

- Chrome plated
- 2" screws
- UPC listed



PART NO.	DESCRIPTION	# OF HOLES	CTN/MSTR
T05012	1-hole with screw	1	20/200
T05013	2-hole with screws	2	20/200
T05010	1-hole less screw	1	20/200
T05011	2-hole less screw	2	20/200
T05021	1/4" x 2" chrome plated screw	—	100/1000

Trip Levers With Spring



Round

- Chrome plated
- Coil-type spring
- 2" screws

PART NO.	DESCRIPTION	CTN/MSTR
T05002	Round trip lever less screws	25/200
T05003	Round trip lever with 2" screws	25/200
T05021	1/4" x 2" chrome plated screw	500/2000

Faceplate Gasket and Shoe Gasket



T05025



T05026

• CARTON QUANTITIES ONLY

PART NO.	DESCRIPTION	CTN/MSTR
T05025	Beveled faceplate gasket 2 1/8" ID x 3 3/16" OD - 9/16"-3/16" thick	25/300
T05026	Shoe gasket 1 3/4" ID x 2 5/8" OD - 3/32" thick	25/50

Wraparound Sponge Rubber Face Plate Gasket



- Grips top elbow for easy installation

PART NO.	DESCRIPTION	CTN/MSTR
T05029	Wraparound sponge rubber face gasket	25/500

#15 Plumb Kit



- Stainless steel flange (S01041)
- 1/2" x 6" chrome plated brass shower arm (S01030)
- Chrome plated plastic shower head with brass ball (S01003)

PART NO.	DESCRIPTION	CTN/MSTR
S03220	#15 Plumb kit	1/25

#51 Plumb Kit



- Chrome plated flange with set screw (S01040)
- 1/2" x 6" chrome plated brass shower arm (S01030)
- Chrome plated die cast adjustable shower head (S01005)

PART NO.	DESCRIPTION	CTN/MSTR
S03222	#51 Plumb kit	1/25

Bathtub Protectors



- High impact plastic
- Fluted side walls and foam bottom
- MOTOR FREIGHT (LTL) ONLY
- CARTON QUANTITIES ONLY

For Steel Tubs

PART NO.	DESCRIPTION	CTN QTY
T10014	14" deep x 60" long x 30" wide (steel tubs)	35
T10016	16" deep x 60" long x 42" wide (oval tubs)	25
T10216	16" deep x 60" long x 30" wide (cast iron tubs)	35

Adapter Bushing for Bath Drain



- Brass bushing

PART NO.	DESCRIPTION	CTN/MSTR
T05023	Kohler* bushing	50/200
T05024	1-1/2" MIP x 1-3/8" FIP	50/300

* The manufacturers' names are used only to describe whose products the products will fit.

Standard Waste and 1-Hole Overflow



- Half kit with chrome plated lift and turn
- 2-hole test kit converts to 1-hole faceplate

PART NO.	DESCRIPTION	MATERIAL	CTN/MSTR
B07220T	Waste and overflow kit	PVC	1/24
B07221T	Waste and overflow kit	ABS	1/24

Standard Waste and 2-Hole Overflow



- Half kit with satin nickel lift and turn
- 2-hole faceplate

PART NO.	DESCRIPTION	MATERIAL	CTN/MSTR
B07114S	Waste and overflow kit	PVC	1/24
B07111S	Waste and overflow kit	ABS	1/24

Standard Waste and Overflow



- Full kit with chrome plated friction lift
- Includes bar
- 1-hole face plate

PART NO.	DESCRIPTION	MATERIAL	CTN/MSTR
B07219	Waste and overflow kit	PVC	1/10

Bath Drains



- Chrome plated
- 2-11/16" OD
- P35061 and P35060 have a zinc body, P35066 is brass

PART NO.	DESCRIPTION	CTN/MSTR
P35061	1-3/8" (1-5/8" thread OD) lift and turn	1/100
P35060	1-1/2" (1-7/8" thread OD) lift and turn	1/100
P35066	1-1/2" (1-7/8" thread OD) lift and turn	1/100



- Chrome plated zinc

PART NO.	DESCRIPTION	CTN/MSTR
P35067	1-1/2" friction lift	1/100
P35077	1-3/8" friction lift	1/50



- Chrome plated zinc
- Includes screw

PART NO.	DESCRIPTION	CTN/MSTR
P35064	1-1/2" grid	1/100



- Chrome plated zinc

PART NO.	DESCRIPTION	CTN/MSTR
P35063	1-3/8" (1-5/8" OD thread) toe touch	1/100
P35062	1-1/2" (1-7/8" OD thread) toe touch	1/100



- Chrome plated
- Replacement cartridge for P35063 and P35062

PART NO.	DESCRIPTION	CTN/MSTR
P35056	5/16" toe touch cartridge	1/300
P35057	5/16" toe touch cartridge	1/250



- 1-3/8" are fine threads
- 1-1/2" are course threads

PART NO.	DESCRIPTION	CTN/MSTR
T05023	Kohler* bushing	50/300
T05024	1-3/8" female- 1-1/2" male bushing	1/1

* The manufacturers' names are used only to describe whose products the products will fit.

Quick Cover-Up Tub Stopper



- Oversized stopper covers the entire tub drain
- Easily installs without the use of tools
- Chrome plated

New!

PART NO.	DESCRIPTION	CTN/MSTR
P35260	Quick cover-up tub stopper	6/24

Roman Tub Drain



- Solid brass construction
- Screws are included
- U-shaped handle design
- Designed to fit D64 series "Code Blue" drains

PART NO.	FINISH	CTN/MSTR
D40000	Chrome Plated	1/50
D40001	Polished Brass (PVD)	1/50
D40002	Satin Nickel (PVD)	1/50

Basin and Bath Stopper



- White hollow rubber with rustproof ring

PART NO.	TRADE SIZE	TOP	BOTTOM	CTN/MSTR
P35125	1-1/4"	1-3/8"	1-3/16"	100/500
P35150	1-1/2"	1-5/8"	1-3/8"	100/500
P35158	1-5/8"	1-25/32"	1-19/32"	100/500
P35175	1-3/4"	1-55/64"	1-11/16"	100/500

Fit-All Stopper



Part No.	Top	Bottom
P35160	1-1/2"	7/8"
P35161	3"	1-1/2"

- White rubber construction

PART NO.	DESCRIPTION	CTN/MSTR
P35160	1"- 1-3/8" basin stopper	100/500
P35161	1-1/2"- 2" bath tub or laundry tub stopper	100/500

Pop-Up Basin Stopper



P36002



P36003



P36004

PART NO.	DESCRIPTION	CTN/MSTR
P36002	Delta* pop-up basin stopper	50/200
P36003	Price-Pfister* pop-up stopper	10/500
P36004	Moen* pop-up basin stopper	1/200

* The manufacturers' names are used only to describe whose products the products will fit.

Flip-It Bath Stopper



- One piece construction of Derlin and ABS
- No tools needed for installation
- Open or close with a flip of the toe
- Fits most popular tub drains (assorted o-rings included)

PART NO.	DESCRIPTION	CTN/MSTR
P35070	Chrome plated flip-it stopper	100/200



- No bending or stooping necessary to operate
- Open or close with a flip of the toe
- Fits most popular tub drains

PART NO.	DESCRIPTION	CTN/MSTR
P35170	Chrome plated flip-it conversion kit	1/25

Schedule 40 Bath Waste Kits - Expanded Views

*See pages 22 - 23 for a complete list of available Schedule 40 Bath Waste Kits

Standard **1-Hole** Schedule 40 Bath Waste Kits

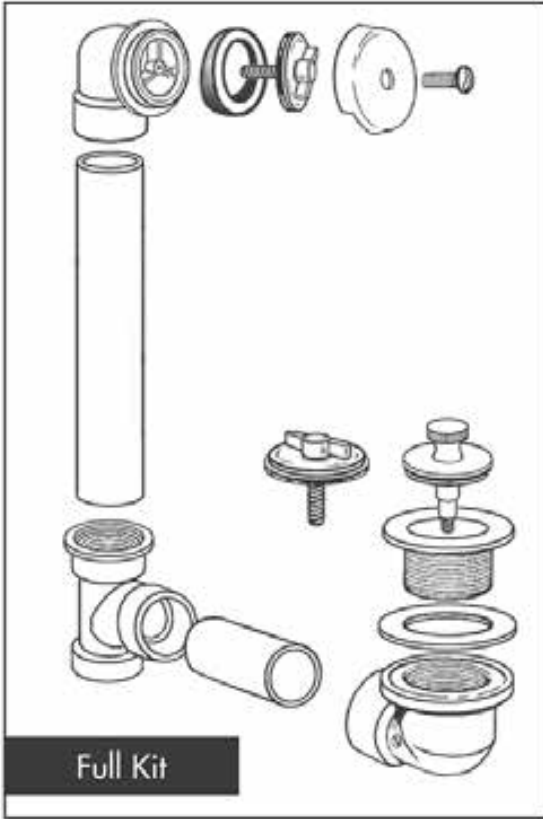

B

Standard **2-Hole** Schedule 40 Bath Waste Kits

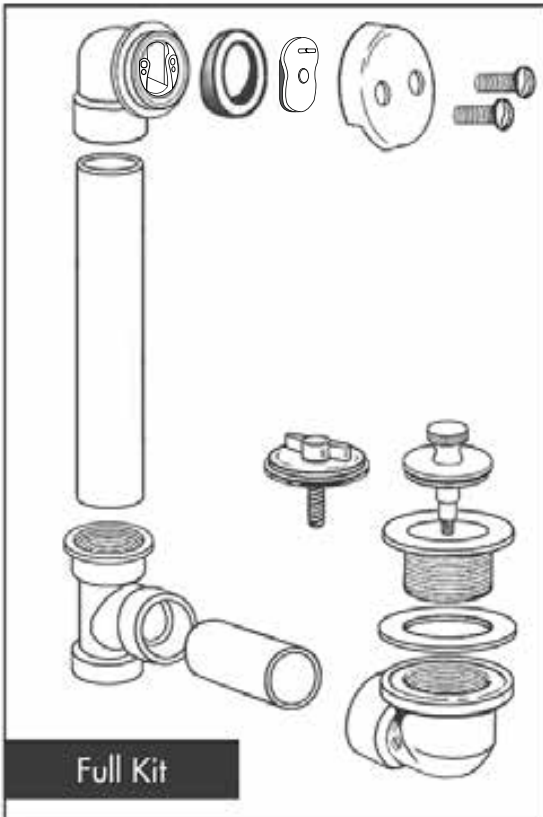

T-Waste 1-Hole Schedule 40 Bath Waste Kits

For use in apartments, motels, hotels - anywhere with back to back baths



T-Waste Kit Benefits:

- Direct access to trap from tub
- Direct waste much less likely to clog
- Solvent weld = homogeneous
- Code required for back to back installation
- Never needs access through walls or ceilings

- NO ACCESS PANEL NEEDED!
- 1-hole faceplates
- Bolt holes on top elbows are pre-threaded
- All drains 3/8" thread size for testing
- UPC listed

Note: Please use suffix "T" when ordering any waste and overflow kit to have test kit included. Add \$4.99 to list price. When a complete kit with a 2-hole test kit is ordered, a 1-hole faceplate with aluminum conversion bar will be supplied.



Half Kit - Lift and Turn Drain



Half Kit - Toe Touch Drain

T-Waste Half Kit- No Pipe Or Elbow

PART NO.	MATERIAL	DESCRIPTION	# HOLES	CTN/MSTR
B07038	PVC	CP brass lift and turn	1	1/24
B07001	PVC	CP lift and turn	1	1/24
B07005	PVC	PB lift and turn	1	1/24
B07003	PVC	CP toe touch	1	1/24
B07007	PVC	PB toe touch	1	1/24
B07040	PVC	CP friction lift	1	1/24
B07042	PVC	PB friction lift	1	1/24
B07006	ABS	PB lift and turn	1	1/24
B07039	ABS	CP brass lift and turn	1	1/24
B07002	ABS	CP lift and turn	1	1/24
B07004	ABS	CP toe touch	1	1/24
B07008	ABS	PB toe touch	1	1/24
B07041	ABS	CP friction lift	1	1/24
B07043	ABS	PB friction lift	1	1/24



Full Kit - Lift and Turn Drain



Full Kit - Toe Touch Drain

T-Waste Full Kit- Includes Pipe and 90° Elbow

PART NO.	MATERIAL	DESCRIPTION	# HOLES	CTN/MSTR
B07044	PVC	CP brass lift and turn	1	1/10
B07020	PVC	CP lift and turn	1	1/10
B07024	PVC	PB lift and turn	1	1/10
B07022	PVC	CP toe touch	1	1/10
B07046	PVC	CP friction lift	1	1/10
B07048	PVC	PB friction lift	1	1/10
B07045	ABS	CP brass lift and turn	1	1/10
B07021	ABS	CP lift and turn	1	1/10
B07025	ABS	PB lift and turn	1	1/10
B07023	ABS	CP toe touch	1	1/10
B07027	ABS	PB toe touch	1	1/10
B07047	ABS	CP friction lift	1	1/10
B07049	ABS	PB friction lift	1	1/10

T-Waste 2-Hole Schedule 40 Bath Waste Kits

For use in apartments, motels, hotels - anywhere with back to back baths



T-Waste Kit Benefits:

- Direct access to trap from tub
- Direct waste much less likely to clog
- Solvent weld = homogeneous
- Code required for back to back installation
- Never needs access through walls or ceilings

- NO ACCESS PANEL NEEDED!
- 2-hole faceplates
- Bolt holes on top elbow are pre-threaded
- All drains 3/8" thread size for testing
- UPC listed

Note: Please use suffix "T" when ordering any waste and overflow kit to have test kit included. Add \$4.99 to list price. When a complete kit with a 2-hole test kit is ordered, a 1-hole faceplate with aluminum conversion bar will be supplied.



Half Kit - Lift and Turn Drain



Half Kit - Toe Touch Drain

T-Waste Half Kit- No Pipe Or Elbow

PART NO.	MATERIAL	DESCRIPTION	# HOLES	CTN/MSTR
B07138	PVC	CP brass lift and turn	2	1/24
B07101	PVC	CP lift and turn	2	1/24
B07105	PVC	PB lift and turn	2	1/24
B07103	PVC	CP toe touch	2	1/24
B07107	PVC	PB toe touch	2	1/24
B07140	PVC	CP friction lift	2	1/24
B07142	PVC	PB friction lift	2	1/24
B07139	ABS	CP brass lift and turn	2	1/24
B07102	ABS	CP lift and turn	2	1/24
B07106	ABS	PB lift and turn	2	1/24
B07104	ABS	CP toe touch	2	1/24
B07108	ABS	PB toe touch	2	1/24
B07141	ABS	CP friction lift	2	1/24
B07143	ABS	PB friction lift	2	1/24



Full Kit - Lift and Turn Drain



Full Kit - Toe Touch Drain

T-Waste Full Kit- Includes Pipe and 90° Elbow

PART NO.	MATERIAL	DESCRIPTION	# HOLES	CTN/MSTR
B07144	PVC	CP brass lift and turn	2	1/10
B07120	PVC	CP lift and turn	2	1/10
B07124	PVC	PB lift and turn	2	1/10
B07122	PVC	CP toe touch	2	1/10
B07126	PVC	PB toe touch	2	1/10
B07146	PVC	CP friction lift	2	1/10
B07148	PVC	PB friction lift	2	1/10
B07121	ABS	CP lift and turn	2	1/10
B07125	ABS	PB lift and turn	2	1/10
B07123	ABS	CP toe touch	2	1/10
B07127	ABS	PB toe touch	2	1/10
B07147	ABS	CP friction lift	2	1/10
B07149	ABS	PB friction lift	2	1/10

Standard 1-Hole Schedule 40 Bath Waste Kits

- 1-hole faceplates
- Bolt holes on top elbows are pre-threaded
- All drains 3/8" thread size for testing
- UPC listed



Note: Please use suffix "T" when ordering any waste and overflow kit to have test kit included. Add \$4.99 to list price. When a complete kit with a 2-hole test kit is ordered, a 1-hole faceplate with aluminum conversion bar will be supplied.



Half Kit - Lift and Turn Drain



Half Kit - Toe Touch Drain

Standard Half Kit- No Pipe or Tee

PART NO.	MATERIAL	DESCRIPTION	# HOLES	CTN/MSTR
B07050	PVC	CP brass lift and turn	1	1/24
B07010	PVC	CP lift and turn	1	1/24
B07014	PVC	PB lift and turn	1	1/24
B07012	PVC	CP toe touch	1	1/24
B07016	PVC	PB toe touch	1	1/24
B07052	PVC	CP friction lift	1	1/24
B07054	PVC	PB friction lift	1	1/24
B07051	ABS	CP brass lift and turn	1	1/24
B07011	ABS	CP lift and turn	1	1/24
B07015	ABS	PB lift and turn	1	1/24
B07013	ABS	CP toe touch	1	1/24
B07017	ABS	PB toe touch	1	1/24
B07053	ABS	CP friction lift	1	1/24
B07055	ABS	PB friction lift	1	1/24



Full Kit - Lift and Turn Drain



Full Kit - Toe Touch Drain

Standard Full Kit- Includes Pipe and Tee

PART NO.	MATERIAL	DESCRIPTION	# HOLES	CTN/MSTR
B07056	PVC	CP brass lift and turn	1	1/10
B07030	PVC	CP lift and turn	1	1/10
B07034	PVC	PB lift and turn	1	1/10
B07032	PVC	CP toe touch	1	1/10
B07036	PVC	PB toe touch	1	1/10
B07058	PVC	CP friction lift	1	1/10
B07060	PVC	PB friction lift	1	1/10
B07057	ABS	CP brass lift and turn	1	1/10
B07031	ABS	CP lift and turn	1	1/10
B07035	ABS	PB lift and turn	1	1/10
B07033	ABS	CP toe touch	1	1/10
B07037	ABS	PB toe touch	1	1/10
B07059	ABS	CP friction lift	1	1/10
B07061	ABS	PB friction lift	1	1/10

Items marked with the Jones Stephens logo are "You Need It...We Got It" Items.

Standard 2-Hole Schedule 40 Bath Waste Kits

- 2-hole faceplates
- Bolt holes on top elbow are pre-threaded
- All drains 3/8" thread size for testing
- UPC listed



Note: Please use suffix "T" when ordering any waste and overflow kit to have test kit included. Add \$4.99 to list price. When a complete kit with a 2-hole test kit is ordered, a 1-hole faceplate with aluminum conversion bar will be supplied.



Half Kit - Lift and Turn Drain



Half Kit - Toe Touch Drain

Standard Half Kit- No Pipe or Tee

PART NO.	MATERIAL	DESCRIPTION	# HOLES	CTN/MSTR
B07150	PVC	CP brass lift and turn	2	1/24
B07110	PVC	CP lift and turn	2	1/24
B07114	PVC	PB lift and turn	2	1/24
B07112	PVC	CP toe touch	2	1/24
B07116	PVC	PB toe touch	2	1/24
B07152	PVC	CP friction lift	2	1/24
B07154	PVC	PB friction lift	2	1/24
B07151	ABS	CP brass lift and turn	2	1/24
B07111	ABS	CP lift and turn	2	1/24
B07115	ABS	PB lift and turn	2	1/24
B07113	ABS	CP toe touch	2	1/24
B07117	ABS	PB toe touch	2	1/24
B07153	ABS	CP friction lift	2	1/24
B07155	ABS	PB friction lift	2	1/24



Full Kit - Lift and Turn Drain



Full Kit - Toe Touch Drain

Standard Full Kit- Includes Pipe and Tee

PART NO.	MATERIAL	DESCRIPTION	# HOLES	CTN/MSTR
B07156	PVC	CP brass lift and turn	2	1/10
B07130	PVC	CP lift and turn	2	1/10
B07134	PVC	PB lift and turn	2	1/10
B07132	PVC	CP toe touch	2	1/10
B07136	PVC	PB toe touch	2	1/10
B07158	PVC	CP friction lift	2	1/10
B07160	PVC	PB friction lift	2	1/10
B07157	ABS	CP brass lift and turn	2	1/10
B07131	ABS	CP lift and turn	2	1/10
B07135	ABS	PB lift and turn	2	1/10
B07133	ABS	CP toe touch	2	1/10
B07137	ABS	PB toe touch	2	1/10
B07159	ABS	CP friction lift	2	1/10
B07161	ABS	PB friction lift	2	1/10

B

Bath Waste and Overflow Test Kit



• Drain thread size is 3/8"

PART NO.	DESCRIPTION	CTN/MSTR
B07201	1-hole kit without screws or plate	1/200
B07202	2-hole kit includes screws and plate	1/200

Aluminum Bar for Waste and Overflow



- Holds overflow ell to tub
- Converts 2-hole faceplate to 1-hole faceplate

PART NO.	DESCRIPTION	CTN/MSTR
B07200	Aluminum bar with 2 screws	1/500
B07203	1-hole overflow face plate with aluminum bar	1

Bath Waste Trim Kits



- Chrome plated
- Includes overflow plate, screws and stopper

PART NO.	DESCRIPTION	# HOLES	CTN/MSTR
B07071	Trim kit with lift and turn stopper	1	1/1
B07073	Trim kit with friction lift stopper	1	1/1
B07171	Trim kit with lift and turn stopper	2	1/1
B07173	Trim kit with friction lift stopper	2	1/1

Polished Brass Faceplate Trim Kit



- Includes overflow plate, screws and lift and turn stopper
- PVD finish

PART NO.	DESCRIPTION	# HOLES	CTN/MSTR
B08071	1-hole face plate trim kit	1	1/1

Conversion Kit with Cross Bar



- 1-3/8" chrome plated zinc drain
- Includes cross bar
- 1-hole faceplate
- Includes bushing for 1-1/2" installation

PART NO.	DESCRIPTION	CTN/MSTR
B51019	CP lift and turn conversion kit	6/36
B51020	PB lift and turn conversion kit	1/12
B07210	CP friction lift conversion kit	1/1

Trip Lever Trim Only



- Chrome plated
- 2-hole faceplate
- Includes springs, faceplate, 2 screws and strainer
- Clamshell packaging

PART NO.	DESCRIPTION	# HOLES	CTN/MSTR
B51014	Chrome plated trip lever trim only	2	5/25

Trip Lever Conversion Kit



- Chrome plated
- Fits 1-3/8" or 1-1/2" waste elbows
- Includes drain, bushing, faceplate and 2 screws
- Clamshell packaging

PART NO.	DESCRIPTION	# HOLES	CTN/MSTR
B51015	Chrome plated trip lever conversion kit	2	5/25

Bath Waste Conversion Kits



- B51006, B51008, B51011 are 1-1/2" kits
- All others are 1-1/2"x 1-3/8" and include bushings
- Carded for display

PART NO.	DESCRIPTION	# HOLES	CTN/MSTR
B51005	CP lift and turn kit	2	6/36
B51006	White lift and turn kit	2	1/1
B51007	CP toe touch kit	2	1/1
B51008	CP friction lift kit	2	1/1
B51009	CP lift and turn kit	1	1/1
B51010	CP toe touch kit	1	1/1
B51011	CP friction lift kit	1	1/1

Schedule 40 Bath Waste Rough-In Kit



- Chrome plated drain body
- Standard rough-in kit

PART NO.	MATERIAL	DESCRIPTION	# HOLES	CTN/MSTR
B07074	PVC	Lift and turn drain body	1	1/1
B07374	ABS	Lift and turn drain body	1	1/1
B07075	PVC	Friction lift drain body	1	1/1
B07375	ABS	Friction lift drain body	1	1/1
B07076	PVC	Lift and turn drain body	2	1/1
B07376	ABS	Lift and turn drain body	2	1/1
B07077	PVC	Friction lift drain body	2	1/1
B07377	ABS	Friction lift drain body	2	1/1

Schedule 40 Bath Waste Rough-In Kits with Test Kit



- Chrome plated drain body
- Standard rough-in kit
- Includes test kit and aluminum bar with screws

PART NO.	MATERIAL	DESCRIPTION	# HOLES	CTN/MSTR
B07070	PVC	Lift and turn drain body	1	1/1
B07470	ABS	Lift and turn drain body	1	1/1
B07072	PVC	Friction lift drain body	1	1/1
B07472	ABS	Friction lift drain body	1	1/1
B07170	PVC	Lift and turn drain body	2	1/1
B07476	ABS	Lift and turn drain body	2	1/1
B07172	PVC	Friction lift drain body	2	1/1
B07477	ABS	Friction lift drain body	2	1/1

Plunge Right



- Easily unplug a clogged drain
- Eliminates use of a rag to plug overflow
- Seal allows for full utilization of pressure to remove clog
- Reusable

PART NO.	DESCRIPTION	# HOLES	CTN/MSTR
J40016	2-Hole plunge right	2	1/1
J40017	1-Hole plunge right	1	1/1

Grab Bar with Exposed Flange



Satin Finish



Peened Finish

- 18 gauge stainless steel
- Meets 900 lb. downward pull when installed properly
- Meets federal specification WW-P-541/8B, Amendment 1, 16 April 1990
- Meets ANSI 117.1 and all ADA Code requirements
- Meets federal specifications for FHA, VA hospital, private construction
- Individually bagged with stainless steel mounting screws

Satin Finish

PART NO.	DESCRIPTION	FINISH	CTN/MSTR
G12012	1-1/4" x 12"	Satin	1/5
G12016	1-1/4" x 16"	Satin	1/5
G12018	1-1/4" x 18"	Satin	1/5
G12024	1-1/4" x 24"	Satin	1/5
G12030	1-1/4" x 30"	Satin	1/5
G12032	1-1/4" x 32"	Satin	1/5
G12036	1-1/4" x 36"	Satin	1/5
G12042	1-1/4" x 42"	Satin	1/5
G12048	1-1/4" x 48"	Satin	1/5
G13012	1-1/2" x 12"	Satin	1/5
G13016	1-1/2" x 16"	Satin	1/5
G13018	1-1/2" x 18"	Satin	1/5
G13024	1-1/2" x 24"	Satin	1/5
G13030	1-1/2" x 30"	Satin	1/5
G13032	1-1/2" x 32"	Satin	1/5
G13036	1-1/2" x 36"	Satin	1/5
G13042	1-1/2" x 42"	Satin	1/5
G13048	1-1/2" x 48"	Satin	1/5

Peened Finish

PART NO.	DESCRIPTION	FINISH	CTN/MSTR
G12212	1-1/4" x 12"	Peened	1/5
G12216	1-1/4" x 16"	Peened	1/5
G12218	1-1/4" x 18"	Peened	1/5
G12224	1-1/4" x 24"	Peened	1/5
G12230	1-1/4" x 30"	Peened	1/5
G12232	1-1/4" x 32"	Peened	1/5
G12236	1-1/4" x 36"	Peened	1/5
G12242	1-1/4" x 42"	Peened	1/5
G12248	1-1/4" x 48"	Peened	1/5
G13212	1-1/2" x 12"	Peened	1/5
G13216	1-1/2" x 16"	Peened	1/5
G13218	1-1/2" x 18"	Peened	1/5
G13224	1-1/2" x 24"	Peened	1/5
G13230	1-1/2" x 30"	Peened	1/5
G13232	1-1/2" x 32"	Peened	1/5
G13236	1-1/2" x 36"	Peened	1/5
G13242	1-1/2" x 42"	Peened	1/5
G13248	1-1/2" x 48"	Peened	1/5

Items marked with the Jones Stephens logo are "You Need It... We Got It" Items.

Grab Bar with Concealed Snap-On Flange



Satin Finish



Peened Finish

- 18 gauge stainless steel
- Meets 900 lb. downward pull when installed properly
- Meets federal specification WW-P-541/8B, Amendment 1, 16 April 1990
- Meets ANSI 117.1 and all ADA Code requirements
- Meets federal specifications for FHA, VA hospital, private construction
- Individually bagged with stainless steel mounting screws

Satin Finish

PART NO.	DESCRIPTION	FINISH	CTN/MSTR
G12112	1-1/4" x 12"	Satin	1/5
G12116	1-1/4" x 16"	Satin	1/5
G12118	1-1/4" x 18"	Satin	1/5
G12124	1-1/4" x 24"	Satin	1/5
G12130	1-1/4" x 30"	Satin	1/5
G12132	1-1/4" x 32"	Satin	1/5
G12136	1-1/4" x 36"	Satin	1/5
G12142	1-1/4" x 42"	Satin	1/5
G12148	1-1/4" x 48"	Satin	1/5
G13112	1-1/2" x 12"	Satin	1/5
G13116	1-1/2" x 16"	Satin	1/5
G13118	1-1/2" x 18"	Satin	1/5
G13124	1-1/2" x 24"	Satin	1/5
G13130	1-1/2" x 30"	Satin	1/5
G13132	1-1/2" x 32"	Satin	1/5
G13136	1-1/2" x 36"	Satin	1/5
G13142	1-1/2" x 42"	Satin	1/5
G13148	1-1/2" x 48"	Satin	1/5

Peened Finish

PART NO.	DESCRIPTION	FINISH	CTN/MSTR
G12312	1-1/4" x 12"	Peened	1/5
G12316	1-1/4" x 16"	Peened	1/5
G12318	1-1/4" x 18"	Peened	1/5
G12324	1-1/4" x 24"	Peened	1/5
G12330	1-1/4" x 30"	Peened	1/5
G12332	1-1/4" x 32"	Peened	1/5
G12336	1-1/4" x 36"	Peened	1/5
G12342	1-1/4" x 42"	Peened	1/5
G12348	1-1/4" x 48"	Peened	1/5
G13312	1-1/2" x 12"	Peened	1/5
G13316	1-1/2" x 16"	Peened	1/5
G13318	1-1/2" x 18"	Peened	1/5
G13324	1-1/2" x 24"	Peened	1/5
G13330	1-1/2" x 30"	Peened	1/5
G13332	1-1/2" x 32"	Peened	1/5
G13336	1-1/2" x 36"	Peened	1/5
G13342	1-1/2" x 42"	Peened	1/5
G13348	1-1/2" x 48"	Peened	1/5

Grab Bar Fastening System



- Made of stainless steel
- Will hold up to 1000 lbs. per grab bar
- Blocking/studs are not required

PART NO.	DESCRIPTION	CTN/MSTR
G12999	Commercial grab bar wing lt	1/60

Brass Pop-Up Assembly/Replacement Parts

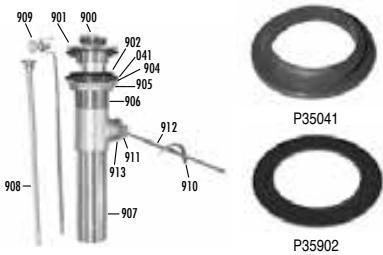

- All metal construction
- Tool free locknut and ballrod top
- 17 gauge

PART NO.	DESCRIPTION	CTN/MSTR
P35001	Chrome-brass	1/50

Replacement Parts

PART NO.	DESCRIPTION	CTN/MSTR
P35041	1-1/4" mack gasket	1/500
P35900	Universal plastic plunger with CP brass cap	1/25
P35901	CP stainless steel flange	16/800
P35902	Flat rubber washer	1/25
P35904	Polyethylene washer	1/1000
P35905	Brass locknut	1/25
P35906	CP brass drain body	1/250
P35907	CP brass tailpiece	1/250
P35908	Stainless steel lift rod	1/500
P35909	Steel clevis with thumb screw	1/25
P35910	Stainless steel spring clip	1/2000
P35911	CP brass ball nut	1/600
P35912	CP steel ball rod with plastic all (6-3/8" long)	1/150
P35913	Friction washer - under nut (not visible)	1/600

Lav Lift and Lock Pop-Up Drain



- Chrome plated

PART NO.	DESCRIPTION	CTN/MSTR
P35000	CP lift and lock pop-up (with overflow holes)	1/50
P35003	CP lift and lock pop-up (without overflow holes)	1/50

ABS Lav Pop-Up Assembly



- Carded

PART NO.	DESCRIPTION	CTN/MSTR
P35004	Grey plastic	1/30

Chrome Plated ABS Lav Pop-Up Assembly



- Carded

PART NO.	DESCRIPTION	CTN/MSTR
P35005	Chrome plated plastic	1/30

Items marked with the Jones Stephens logo are "You Need It...We Got It" Items.

Brass Lav P.O. Plug Drain



- With chain and stopper
- With overflow
- 17 gauge

PART NO.	DESCRIPTION	CTN/MSTR
D70103	1-1/4" P.O. plug drain	1/50

Trap Primer Tailpiece



- Chrome plated 17 gauge tubular
- Sturdy one-piece construction eliminates leaks and cross-threading
- 3/4" compression nut

PART NO.	DESCRIPTION	CTN/MSTR
T74010	1-1/4" x 8" - threaded top	1/50
T74011	1-1/2" x 8" - slip joint top direct connection	1/50

Handicap Style Lav Grid Drain



- Polished chrome plated brass
- Twin 90° construction
- Mack washer and brass locknut
- 17 gauge 1-1/4" tailpiece; cast brass elbows
- With overflow
- UPC listed



PART NO.	DESCRIPTION	CTN/MSTR
D70101	Handicap style lav grid drain	1/25
D70104	Handicap style lav grid drain with one piece tubular elbow	1/25

Commercial Handicap Style Lav Grid Drain with Elbow



- Polished chrome plated brass; cast brass elbow
- 1-1/4" female thread
- Complete with gaskets and brass locknut

PART NO.	DESCRIPTION	CTN/MSTR
D70102	Handicap style lav grid drain with elbow	1/48

Commercial Lav Grid Drain without Overflow Holes



- Chrome plated
- 17 gauge
- For vessel sinks

PART NO.	DESCRIPTION	CTN/MSTR
D70105	Chrome plated grid drain	1/50

Commercial Lav Grid Drain



- Stainless steel
- Mack washer and brass locknut
- 17 gauge 1-1/4" tailpiece; 6" long

PART NO.	DESCRIPTION	CTN/MSTR
D70100	Commercial lav drain	1/50

Commercial P-Trap with Cleanout



- Chrome plated
- Brass nuts
- 17 gauge semi-cast p-trap
- 17 gauge tubular wall bend
- Carded
- J37124 is UPC listed



PART NO.	DESCRIPTION	CTN/MSTR
J37124	1-1/4" OD with cleanout	1/12
J37150	1-1/2" OD with cleanout	1/12

Chrome Plated PVC P-Trap



- Complete with nuts, washers and escutcheon

PART NO.	DESCRIPTION	CTN/MSTR
P36102	1-1/4" p-trap	1/50
P36103	1-1/2" p-trap	1/50

Flush Valve Pipe Support



- Chrome plated split ring type
- 1-1/2" OD size
- 5" center of pipe to wall
- Mounting hardware included

PART NO.	DESCRIPTION	CTN/MSTR
F39800	1-1/2" x 5" pipe support	5/50
F39700	1-1/2" x 3 1/2" pipe support	10/100

Tissue Roller



- CARTON QUANTITIES ONLY

PART NO.	DESCRIPTION	CTN/MSTR
B10195	Fit-All white plastic	50/200

Provent



- Manufactured housing and RV's only
- Automatic anti-siphon trap vent used as secondary venting
- Must be located at least 60" above trap arm
- Two individually protected fixtures may be connected to same 1-1/2" drain
- Three or more fixtures must be drained by 2" line
- Simply hand tighten, no thread seal needed
- Water closet must have main stack to outside
- Must be installed in accessible location with free flow air
- Do not install in sealed wall cavity
- 1-1/2" MPT threads

PART NO.	DESCRIPTION	CTN/MSTR
P21150	1-1/2" Provent	1/200

Air Gap



- Prevents sewage backflow by breaking siphoning action in drain line
- White polypro body with chrome plated ABS top
- UPC listed



PART NO.	DESCRIPTION	CTN/MSTR
A10001	Air gap	36/72

Items marked with the Jones Stephens logo are "You Need It... We Got It" Items.

Air Gap Spacer



PART NO.	DESCRIPTION	CTN/MSTR
A10901	Air gap spacer	1/25

Air Gap Dishwasher Kit



- Contains air gap, 24" dishwasher hose (7/8"), and 2 gear clamps
- Poly bagged and labeled

PART NO.	DESCRIPTION	CTN/MSTR
A10100	Air gap installation pack	1/10
A10200	Air gap installation pack-white	1/10
A10150	Air gap deluxe pack (includes dishwasher elbow and vacuum breaker)	1/10

Plumb Aire Air Vent



- Up to 160 fixture units
- May be exposed to temperatures ranging from -40° + 150°F
- No protective cover required when installed per code specifications
- Back pressure rated to 20 PSI

PART NO.	DESCRIPTION	MATERIAL	CTN/MSTR
P21100	Plumb Aire vent- 1-1/2"x 2"	PVC	1/20
P21101	Plumb Aire vent with adapter	PVC	1/20
P21102	Plumb Aire vent - 1-1/2"x 2"	ABS	1/20
P21103	Plumb Aire vent with adapter	ABS	1/20

Adapter for Air Inlet Valve

PART NO.	DESCRIPTION	MATERIAL	CTN/MSTR
P21104	Adapter for air inlet valve	PVC	1/20
P21107	Adapter for air inlet valve	ABS	1/20

Rosettes



- CARTON QUANTITIES ONLY

PART NO.	DESCRIPTION	CTN/MSTR
B10110	Shallow pattern (zinc plated)	25/5000
B10111	Deep pattern (zinc plated)	25/1000

Basin Cock Locknut



- CARTON QUANTITIES ONLY

PART NO.	DESCRIPTION	MATERIAL	CTN/MSTR
B10080	1/2"- 14 hex locknut	Zamak	25/1000
B10081	1/2"- 14 flanged hex locknut	Zamak	25/750

Basket Strainer Locknuts and Washers



Locknut



Rubber Washer



Friction Washer

- Die cast zinc
- CARTON QUANTITIES ONLY

PART NO.	DESCRIPTION	CTN/MSTR
B10090	1-1/2" locknut	25/350
B10091	2" locknut	25/350
B10092	3-3/8" locknut for 4" duo strainer	25/350
B10093	3-3/8" heavy pattern locknut for 4" duo strainer	25/100
B10094	Basket strainer rubber washer (4-7/16" OD)	25/300

Fiber Friction Washer

PART NO.	DESCRIPTION	CTN/MSTR
D02002	Basket strainer friction washer (4-3/16" OD) [fiber friction washer]	1/100

Ballcock Coupling Nut and Locknut



- CARTON QUANTITIES ONLY

PART NO.	DESCRIPTION	CTN/MSTR
C05080	5/8" x 1/2" 7 threads zinc die cast	25/500
C05081	5/8" x 7/8" brass	20/400
C05082	15/16"- 14 locknut	25/500

Plastic Slip Joint Nut



- White
- CARTON QUANTITIES ONLY (T85125 and T85150)

PART NO.	DESCRIPTION	CTN/MSTR
T83150	1-1/2" with wings	100/1200
T85125	1-1/4" x 1-1/4"	100/1200
T85150	1-1/2" x 1-1/2"	100/1200

Basin Nut



- CARTON QUANTITIES ONLY

PART NO.	DESCRIPTION	MATERIAL	CTN/MSTR
B10100	1/2" - 14 x 3/8"	Zamak	25/500
B10102	1/2" - 14 x 1/2"	Zamak	25/500
B10103	1/2" - 14 x 9/16"	Zamak	25/500
B10104	1/2" - 14 x 9/16"	Brass	10/500

Sink Connection Washer



- CARTON QUANTITIES ONLY

PART NO.	DESCRIPTION	CTN/MSTR
T79000	1-3/4" x 1-3/8" x 1/8"	100/1000

Split Nut



- Replace fractured or stripped slip nuts without tubular disassembly
- Supplied with washer

PART NO.	DESCRIPTION	CTN/MSTR
T82125	1-1/4" split nut	100/400
T82150	1-1/2" split nut	100/400

Slip Joint Nut



- CARTON QUANTITIES ONLY

PART NO.	IPS x SLIP TUBE	MATERIAL	CTN/MSTR
T77125	1-1/4" x 1-1/4"	Die Cast Zinc	25/500
T77138	1-1/2" x 1-3/8"	Die Cast Zinc	400/800
T77150	1-1/2" x 1-1/2"	Die Cast Zinc	25/300
T77151	1-1/2" x 1-1/4"	Die Cast Zinc	25/300
T77152	2" x 1-1/2"	Die Cast Zinc	25/300
T77200	2" x 2"	Die Cast Zinc	25/200
T78125	1-1/4" x 1-1/4"	Chrome Plated Brass	200/400
T78150	1-1/2" x 1-1/2"	Chrome Plated Brass	200/400
T78151	1-1/2" x 1-1/4"	Chrome Plated Brass	200/400
T78152	2" x 1-1/2"	Chrome Plated Brass	125/250
T78200	2" x 2"	Chrome Plated Brass	25/250

Rough Brass Slip Joint Nut



- Heavy cast brass
- CARTON QUANTITIES ONLY

PART NO.	IPS x SLIP TUBE	MATERIAL	CTN/MSTR
T84125	1-1/4" x 1-1/4"	Cast Brass	25/300
T84150	1-1/2" x 1-1/2"	Cast Brass	25/300
T84151	1-1/2" x 1-1/4"	Cast Brass	25/300
T84200	2" x 2"	Cast Brass	25/300

Lavatory Supply Nut



- Wing nut design
- CARTON QUANTITIES ONLY

PART NO.	DESCRIPTION	MATERIAL	CTN/MSTR
B10105	1/2" - 14 x 1/2" white lavatory nut	Plastic	25/1100

Items marked with the Jones Stephens logo are "You Need It... We Got It" Items.

Slip Joint Washer

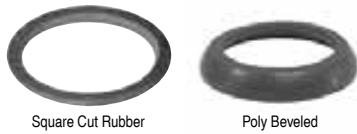

• CARTON QUANTITIES ONLY

Square Cut Rubber

Poly Beveled

Square Cut

PART NO.	NUT x TUBE	MATERIAL	CTN/MSTR
T79125	1-1/4" x 1-1/4"	Black Rubber	100/5600
T79150	1-1/2" x 1-1/2"	Black Rubber	100/5600
T79151	1-1/2" x 1-1/4"	Black Rubber	100/5600
T79200	2" x 2"	Black Rubber	100/2400
T79201	2" x 1-1/2"	Black Rubber	100/2400

Beveled

PART NO.	NUT x TUBE	MATERIAL	CTN/MSTR
T80125	1-1/4" x 1-1/4"	White Rubber	100/5000
T80135	1-1/4" x 1-1/4"	Blue Rubber	100/5000
T80150	1-1/2" x 1-1/2"	White Rubber	100/5000
T80160	1-1/2" x 1-1/2"	Blue Rubber	100/5000
T80151	1-1/2" x 1-1/4"	Blue Rubber	100/5000
T80200	2" x 2"	White Rubber	100/5000

Slip Joint Nut and Washer



• Chrome plated nut packed with square cut rubber washer
• CARTON QUANTITIES ONLY

Die Cast Nut

Brass Nut

Die Cast Nut

PART NO.	DESCRIPTION	MATERIAL	CTN/MSTR
T77014	1-1/4" x 1-1/4"	Die Cast	25/500
T77012	1-1/2" x 1-1/2"	Die Cast	25/500
T77013	1-1/2" x 1-1/4"	Die Cast	25/500
T77020	2" x 2"	Die Cast	25/500

Brass Nut

PART NO.	DESCRIPTION	MATERIAL	CTN/MSTR
T78014	1-1/4" x 1-1/4"	Brass	25/400
T78012	1-1/2" x 1-1/2"	Brass	25/400
T78013	1-1/2" x 1-1/4"	Brass	25/400
T78020	2" x 2"	Brass	25/400

Cone Slip Joint Washer



• Black rubber
• CARTON QUANTITIES ONLY

T85052

T85053

T85054

T85055

PART NO.	NUT	TUBE	OD x ID	CTN/MSTR
T85050	1/2"	3/8"	23/32" x 3/8"	100/1600
T85051	1/2"	3/8" threaded	23/32" x 3/8"	100/1600
T85052	1/2"	7/16" or 1/2"	5/8" x 7/16"	100/1600
T85053	Ballcock supply	-	3/4" x 7/16"	100/1600
T85054	Ballcock supply	-	13/16" x 11/32"	100/1600
T85055	Upper bath supply	-	27/32" x 7/16"	100/1600

Brass Friction Rings



• CARTON QUANTITIES ONLY

PART NO.	NUT	TUBE	OD x ID	CTN/MSTR
T86050	1/2"	3/8"	21/32" x 25/64"	100/100
T86052	1/2"	7/16"	21/32" x 29/64"	100/100
T86053	Ballcock	1/2"	13/16" x 17/32"	100/100
T86054	Ballcock	3/8"	13/16" x 25/64"	100/100
T86055	Ballcock	7/16"	13/16" x 15/32"	100/100

Flanged Poly Tailpiece Washer



• CARTON QUANTITIES ONLY

PART NO.	NUT x TUBE	CTN/MSTR
T81150	1 1/2" x 1 1/2"	100/100
T79152	1 1/2" x 1 1/4" cloth inserted	100/100

Waste Connector



• Brass body ferrule and nut
• MIP units are combination female sweat

FIP x SLIP

PART NO.	DESCRIPTION	CTN/MSTR
T75125	1-1/4" FIP x 1-1/4" OD	12/72
T75150	1-1/2" FIP x 1-1/2" OD	12/72
T75151	1-1/2" FIP x 1-1/4" OD	12/72
T75250	1-1/2" FIP x 1-1/2" OD with poly washer	12/72

MIP x SLIP

PART NO.	DESCRIPTION	CTN/MSTR
T76125	1-1/4" MIP x 1-1/4" OD	12/72
T76150	1-1/2" MIP x 1-1/2" OD	12/72
T76151	1-1/2" MIP x 1-1/4" OD	12/72
T76250	1-1/2" MIP x 1-1/2" OD with poly washer	12/72

Brass Compression Ring

PART NO.	DESCRIPTION	CTN/MSTR
T75000	1-1/4" OD	1/1000
T75001	1-1/2" OD	1/1000

Double Slip Fittings



• Chrome plated brass
• 22 gauge

PART NO.	DESCRIPTION	CTN/MSTR
T74001	1-1/4" coupling	10/100
T74002	1-1/2" coupling	10/100
T74003	1-1/4" 90° elbow	10/100
T74004	1-1/2" 90° elbow	10/100
T74005	1-1/4" 45° elbow	10/100
T74006	1-1/2" 45° elbow	10/100

Items marked with the Jones Stephens logo are "You Need It... We Got It" Items.

Slip Joint Tee



- Chrome plated satin finish cast brass
- Compression ends

PART NO.	DESCRIPTION	CTN/MSTR
C74105	1-1/2" x 1-1/2" x 1-1/2" tee	10/60

90° Drop Ear Elbow

B



- Cast brass
- Lead Free

PART NO.	DESCRIPTION	CTN/MSTR
B55100LF	1/2" FIP x 1/2" FIP	45/180
B55101LF	1/2" FIP x 1/2" CPVC	45/180
B55103LF	1/2" FSWT x 1/2" FSWT	1/100
B55050	1/2" FIP x 1/2" FSWT	60/240

Sweat Male Adapter and Marvel Adapter



- Use on tub spout elbow or closet/urinal stub out adapter

Sweat Male Adapter

Marvel Adapter

Sweat Male Adapter

PART NO.	FSWT x MIP	CTN/MSTR
B55001	1/2" x 1/2"	1/1000
B55002	3/4" x 3/4"	1/1000
B55003	1" SJ x 1" SWT	1/1000

Marvel Adapter

PART NO.	FSWT x MIP	CTN/MSTR
B55004	1 1/4" SJ x 1 1/4" SWT	1/1000
B55005	1 1/2" SJ x 1 1/2" SWT	1/500
B55006	2" SJ x 2" SWT	1/500
B55007	1 1/2" SJ x 1 1/4" SWT	1/500
B55008	1 1/2" SJ x 1 1/2" Tubular	1/500
B55009	1 1/4" SJ x 1 1/4" Tubular	1/500

Assorted Washer Kit



- 210 pieces packaged in reusable plastic case
- Available with flat or beveled washers
- Contains: 40-00, 40-0, 40-1/4, 30-1/4 large, 20-3/8, 20-3/8 medium, 10-3/8 large, 10-1/2 large

PART NO.	DESCRIPTION	CTN/MSTR
J40150	Beveled washer kit	12/24
J40151	Flat washer kit - assorted colors	12/24

O-Ring Kit and Pick

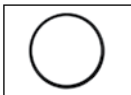

O25199

MADE IN THE USA

- Packed in resealable plastic case with fitting chart on lid
- Manufactured from nitrile compound
- Made in the USA

PART NO.	DESCRIPTION	CTN/MSTR
O25200	200 pc plumbers pack	12/24
O25199	O-ring pick	1/25

Items marked with the Jones Stephens logo are "You Need It... We Got It" Items.

Solid Brass Bibb Screw Assortment Kit



- 208 pieces packaged in reusable plastic case
- Contains: 3/8" x 6-32, 1/2" x 6-32, 3/8" x 8-32, 1/2" x 8-32, 3/8" x 10-24, 1/2" x 6-24, 3/8" x 10-32, 1/2" x 10-32

PART NO.	DESCRIPTION	CTN/MSTR
J40153	Bibb screw assortment	10/40

Faucet Seat Kit



- Reusable compartment box with seat guide on inside cover
- Contains all 36 seats
- Made in the USA

MADE IN THE USA

PART NO.	DESCRIPTION	CTN/MSTR
B40000	144-piece faucet seat kit (36 different parts)	1/4

Faucet Seats



MADE IN THE USA

- All brass
- Made in the USA

PART NO.	FITS BRAND/SIZE	CTN/MSTR
B40001	Speakman* 9/16" x 28 x 3/8"	1/100
B40003	Speakman* 7/16" x 27 x 11/32"	1/100
B40002	American Standard* 7/16" x 24 x 13/32"	1/100
B40004	American Standard* 9/16" x 24" x 3/8"	1/100
B40012	American Standard* 1/2" x 20 x 3/8"	1/100
B40013	American Standard* 1/2" x 20 x 7/16"	1/100
B40021	American Standard* 9/16" x 18 x 3/8"	1/100
B40005	Price Pfister* 1/2" x 20" x 3/8"	1/100
B40006	Price Pfister* .65" x 18 x 3/8"	1/100
B40007	Briggs* Republic* 1/2" x 24 x 7/16"	1/100
B40008	Briggs* Republic* 9/16" x 20 x 3/8"	1/100
B40023	Briggs* 5/8" x 20 x 13/16"	1/100
B40035	Briggs* Republic* 5/8" x 24 x 7/16"	1/100
B40009	Repal* 9/16" x 28 x 11/32"	1/100
B40010	Eljer* 1/2" x 27 x 1/2"	1/100
B40026	Eljer* 1/2" x 20 x 3/8"	1/100
B40011	Kohler* 1/2" x 27 x 3/8"	1/100
B40028	Kohler* 1/2" x 27 x .318"	1/100
B40027	Kohler* Push-In x .348"	1/100
B40014	Central Brass* 9/16" x 27 x 13/32"	1/100
B40018	Central Brass* 1/2" x 24 x .418"	1/100
B40019	Central Brass* 5/8" x 24 x 23/32"	1/100
B40015	Sterling* 1/2" x 24 x 3/8"	1/100
B40017	Universal* 17/32" x 24 x 3/8"	1/100
B40020	Gerber* 5/8" x 20 x 27/64"	1/100
B40024	Dick Brothers* 1/2" x 27 x 13/32"	1/100
B40025	Indiana Brass* 1/2" x 27 x 13/32"	1/100
B40034	Indiana Brass* 9/16" x 27 x 5/8"	1/100
B40030	Union Brass* 5/8" x 18 x 5/16"	1/100
B40033	Union Brass* 5/8" x 18 x 29/32"	1/100
B40032	Sayco* 1/2" x 20 x 5/16"	1/100
B40036	Steamway* 1/2" x 24 x 11/32"	1/100

* The manufacturers' names are used only to describe whose products the products will fit.

Faucet Hole Cover



B10201



B10200

- Stainless steel
- CARTON QUANTITIES ONLY

PART NO.	DESCRIPTION	CTN/MSTR
B10201	1-3/4" OD with washer	25/500
B10202	2" OD with washer	25/500
B10200	1-1/2" snap-in	25/1200

Long Reach Bar Tap Faucet



- 1/4" connection
- 10" meets NSF 61.9
- Can be used with reverse osmosis
- Lead Free

PART NO.	DESCRIPTION	CTN/MSTR
B45014	Long reach bar tap faucet	5/50

Bar Tap Faucet



- Chrome plated brass
- Meets NSF standard 61.9
- 1/4" compression inlet connection
- Kit includes: stem, spring, 2 "o" rings and black handle
- Lead Free
- Individually bagged

PART NO.	DESCRIPTION	CTN/MSTR
B45010	1/4" connection	1/36

Delta* Style Spray Assembly



K55006



K55007

- 4' hose and 1/4" female swivel nut
- Replaces Delta* style thumb-controlled sink sprays and hoses

PART NO.	DESCRIPTION	CTN/MSTR
K55006	Spray assembly	1/50
K55007	Replacement hose only	1/50

* The manufacturers' names are used only to describe whose products the products will fit.

Kitchen Hose and Spray (Fit All)



K52001



K52002

- Reinforced hose with universal coupling adapter
- Automatic off
- Replacement for thumb controlled sink spray
- Individually boxed for display



K52004



K52010

PART NO.	DESCRIPTION	CTN/MSTR
K52001	Head only	1/200
K52002	Head, hose and adapter	1/50
K52003	4' hose and adapter	1/100
K52004	Hose guide	1/500
K52010	White hose and spray	1/100
K52005	White head only	50/200

Items marked with the Jones Stephens logo are "You Need It... We Got It" Items.

Rinse-Quik Hose and Spray



Complete Spray Head Assembly



Spray Head



Pet Sprayer

MADE IN THE
USA

- Individually boxed
- Made in the USA

PART NO.	DESCRIPTION	RQ #	CTN/MSTR
K53001	Black complete spray assembly	(MR4224)	1/50
K53005	White complete spray assembly	(MR-4224WH)	1/50
K53006	Black spray assembly with 1/4" female swivel nut to fit Delta* faucet	(MR422-4C)	1/50
K53002	Black spray head only w/ chrome ring	(MR4-22)	1/100
K53003	4' hose only	(MR-4)	1/50
K53004	Hose guide	(MR-200)	1/10
K53007	Replacement hose for Delta*	(MR4C)	1/100
K53008	White spray head only w/ chrome ring	(MR422WH)	1/100
K53056	Black spray head with black ring	(MR427)	1/100
K53057	White spray head assembly	(MR4274WH)	1/100
K53058	White spray head with white ring	(MR427WH)	1/100
K53055	Black spray head assembly	(MR42474)	1/1
K53077	Black spray head assembly with 6' hose	-	1/1
K53060	Pet sprayer (off-white)	(MR421)	1/1

* The manufacturers' names are used only to describe whose products the products will fit.

Chrome Plated Soap and Lotion Dispenser



- All brass pump
- Large 7 oz. capacity bottle

PART NO.	DESCRIPTION	CTN/MSTR
S08020	Chrome plated dispenser	1/50

Sink Lugs



S58050



S58052



S58051



S58053

- Four lugs bagged with screws
- PRICED PER BAG

PART NO.	DESCRIPTION	CTN/MSTR
S58050	Combo clip for counters 5/8"- 1-1/8" thick	1/100
S58052	E-lug for counters 3/8"- 1/2" thick	1/100
S58051	Adjustable clips for counters 3/4"- 2-3/4" thick	1/100
S58053	KT lug with bolt	1/100

Undermount Sink Installation Kit



- Includes 4 each brackets, brass inserts, washers, bolts and wing nuts
- PRICED PER BAG

PART NO.	DESCRIPTION	CTN/MSTR
S58101	Undermount kit	50/100

Lavatory Legs



- Chrome plated
- Fits vitreous china, steel or cast iron lavatories
- Total length ranges from 31-1/2" to 32-3/4" extended
- Can be cut
- Sold in pairs

PART NO.	DESCRIPTION	CTN/MSTR
L65001	27" legs	1/20

Lavatory and Sink Hangers



L56020



L56026

• Wall mount



L56023



L56024

PART NO.	DESCRIPTION	CTN/MSTR
L56020	Cast iron (for cast iron or vitreous china)	1/24
L56026	Pair cast iron hangers (for cast iron or vitreous china)	1/12
L56023	Steel 10" centers (one piece)	50/100
L56024	7" stamped steel lavatory hanger	50/25

Adjustable Lavatory Hanger



- Durable cast iron
- Adjusts from 10-1/2" to 16"
- For iron, lugs fit into pockets
- For china, remove side lugs

PART NO.	DESCRIPTION	CTN/MSTR
L56027	Lav hanger	1/14

Economy Replacement Basket Strainer



- ABS post
- Stainless steel basket

PART NO.	DESCRIPTION	CTN/MSTR
B03015	Replacement basket	1/200

Fit-All Basket Strainer



- Stainless steel
- Rubber stopper

PART NO.	DESCRIPTION	CTN/MSTR
B03010	Fit-All strainer	1/200

Duo Basket Strainer



- All stainless steel with zinc locknut
- 4-1/2" diameter to fit 3-1/2" drilling
- Basket with rolled edge
- UPC listed



PART NO.	DESCRIPTION	CTN/MSTR
S14001	SS duo strainer	1/50

Flat Top Grid Strainer



- All stainless steel with zinc locknut (less tailpiece)
- 4-1/2" diameter to fit 3-1/2" drilling
- UPC listed



PART NO.	DESCRIPTION	CTN/MSTR
S14002	Flat grid strainer	1/24

Snap Lock Basket Strainer



- All stainless steel
- 4-1/2" diameter to fit 3-1/2" drilling
- Ball bearing basket with rolled edge (less tailpiece)

PART NO.	DESCRIPTION	CTN/MSTR
S14005	Snap lock basket strainer with zinc locknut	1/50
S14010	Snap lock basket strainer with brass locknut	1/50

Shallow Cup Duo Basket Strainer



- 4-1/2" diameter to fit 3-1/2" drilling
- All stainless steel with zinc locknut
- Basket with rolled edge (less tailpiece)
- UPC listed



PART NO.	DESCRIPTION	CTN/MSTR
S14006	Shallow cup duo strainer	1/50

Chrome Plated Brass Duo Strainer



PART NO.	DESCRIPTION	CTN/MSTR
S14007	CP brass duo strainer	1/25
S14011	Replacement strainer	1/150

Twist and Lock Basket Strainer



- All stainless steel with zinc locknut
- 4-1/2" diameter to fit 3-1/2" drilling
- Screw-in basket (less tailpiece)
- UPC listed



PART NO.	DESCRIPTION	CTN/MSTR
S14003	Twist and lock basket strainer	1/24
S14103	Twist and lock replacement basket	1/200

Deep Cup Basket Strainer



- All stainless steel with zinc locknut
- 4-1/2" diameter to fit 3-1/2" drilling
- Basket with rolled edge (less tailpiece)
- UPC listed



PART NO.	DESCRIPTION	CTN/MSTR
S14004	Deep cup basket strainer	1/24

Quick Fit Stainless Steel Basket Strainer



- Durable stainless construction with brass nut
- Minimizes installation time
- Triangle frame mounts to underside
- Fits virtually all sinks
- For replacement basket use B03015
- UPC listed



PART NO.	DESCRIPTION	CTN/MSTR
S14008	Quick fit basket strainer	1/50

Chrome Plated ASAP Basket Strainer



- Durable stainless construction with brass slip nut
- Ideal for quick installation
- Can be installed in less than one minute
- Galvanized retaining ring
- Galvanized locking ring

PART NO.	DESCRIPTION	CTN/MSTR
S14009	ASAP basket strainer	1/24

Items marked with the Jones Stephens logo are "You Need It...We Got It" Items.

Chrome Plated Brass Duo Basket Strainer



- Chrome plated brass body with stainless steel basket
- Heavy duty construction
- Neoprene stopper
- UPC listed



PART NO.	DESCRIPTION	CTN/MSTR
S14250	CP brass duo basket strainer	1/24

Stainless Steel Duo Basket Strainer



- Stainless steel body and basket
- Chrome plated zinc post and slip nut
- Polished inner cup
- Heavy duty rubber gasket and zinc locknut
- UPC listed



PART NO.	DESCRIPTION	CTN/MSTR
S14251	SS duo post style basket strainer	1/50

Stainless Steel Basket Strainer



- Stainless steel body and locknut
- Neoprene stopper
- Spring style snap-in basket
- Compares to DB 14
- UPC listed



PART NO.	DESCRIPTION	CTN/MSTR
S14014	SS cup basket strainer	1/50

Stainless Steel Duo Basket Strainer



- Stainless steel body and locknut
- Neoprene stopper
- Spring style snap-in basket
- UPC listed



PART NO.	DESCRIPTION	CTN/MSTR
S14606	SS duo basket strainer	1/50

ABS Body and Post Basket Strainer



- Plastic nut

PART NO.	DESCRIPTION	CTN/MSTR
S14030	ABS body and post basket strainer	1/50

Deep Junior Duo Basket Strainer



B02102



B02103

- For 2" and 2-1/2" deep outlets and bar sinks

PART NO.	DESCRIPTION	CTN/MSTR
B02102	2" deep basket strainer	1/100
B02103	Replacement strainer	1/250

Junior Duo Basket Strainer



B02050



B02049

- Stainless steel body and basket with die cast locknut; 1-1/2" threads
- Complete with washers
- Fits 1-3/4" bar sink

PART NO.	DESCRIPTION	CTN/MSTR
B02050	Junior duo strainer	1/100
B02049	Replacement basket	100/500

Items marked with the Jones Stephens logo are "You Need It... We Got It" Items.

Flat Duplex Strainer



- Stainless steel body and strainer with die cast locknut
- Complete with washers
- Fits 1-3/4" bar sink

PART NO.	DESCRIPTION	CTN/MSTR
B02052	Flat duplex strainer	1/100

Cast Brass Beehive Urinal Strainer



- Chrome plated brass strainer and body
- Brass locknut
- 2" caulk connection

PART NO.	DESCRIPTION	CTN/MSTR
D45000	Cast brass beehive urinal strainer	1/30
D45001	Replacement top with screws for D45000	1/100

Flexible Hair Strainer



- Soft rubber flexible strainer fits neatly over drain

PART NO.	DESCRIPTION	CTN/MSTR
P35180	Flexible hair strainer	1/1000

1" Brass Bar Plug



- Cast brass
- Includes ground seat plug

PART NO.	DESCRIPTION	CTN/MSTR
B02060	1" x 3" bar plug	1/50

Tray Plug



- Stainless steel body with die cast locknut
- Fits 1-1/2" bar sink
- Complete with washers and stoppers

PART NO.	DESCRIPTION	CTN/MSTR
B02051	Tray plug	1/100

Rubber Hush Cushion



- Black
- Fits In-Sink-Erator

PART NO.	DESCRIPTION	CTN/MSTR
P35159	Rubber hush cushion	1/500

Kitchen Sink and Garbage Disposal Stopper



- Vinyl construction
- Flanged to fit all sizes

PART NO.	DESCRIPTION	CTN/MSTR
P35162	Sink stopper	1/50

Garbage Disposal Splash Guard



- Snap-fit reinforced ring
- Fits all disposal brands

PART NO.	DESCRIPTION	CTN/MSTR
P35163	Rubber fit-all splash guard	1/200

Three Prong Drain Protector



- Stainless steel

PART NO.	DESCRIPTION	CTN QTY
D18062	1 5/8" drain protector	1/2500
D18063	1 7/8" drain protector	1/500

Sink and Basin Crumb Cup



- Nickel plated brass

PART NO.	DESCRIPTION	CTN/MSTR
P35165	1 1/2" crumb cup with post	1/500
P35166	1" crumb cup	1/1000
P35167	1 3/8" crumb cup	1/160

Slotted Full Flow Aerators



Male Thread



Female Thread



Dual Thread

- Chrome plated brass
- Non-corrosive mixing chamber
- 4.5 gpm
- Individually bagged
- Lead Free

PART NO.	DESCRIPTION	CTN/MSTR
A01001	15/16"-27 male thread	25/600
A01002	55/64"-27 female thread	25/600
A01003	Dual threads (15/16"-27 male x 55/64"-27 female)	25/2000

Slotted Reduced Flow Aerator



- NSF listed santoprene washer
- 2.2 gpm
- Meets ANSI A-112.18M
- Easily cleaned
- Individually bagged
- Lead Free

PART NO.	DESCRIPTION	CTN/MSTR
A01004	Dual threads (15/16"-27 male x 55/64"-27 female)	25/600

Non-Slotted Full Flow Aerators



Male Thread



Female Thread



Dual Thread

- 4.5 GPM
- Individually bagged
- Lead Free

PART NO.	DESCRIPTION	CTN/MSTR
A01005	15/16"-27 male thread	25/600
A01006	55/64"-27 female thread	25/600
A01007	13/16"-27 male thread	25/600
A01008	3/4"-27 female thread	25/600
A01010	Dual threads (15/16"-27 male x 55/64"-27 female)	25/600

Items marked with the Jones Stephens logo are "You Need It... We Got It" Items.

Non-Slotted Reduced Flow Aerators



Male Thread



Female Thread



Dual Thread

- Meets ANSI A-112.18M
- Individually bagged
- Lead Free

PART NO.	DESCRIPTION	CTN/MSTR
A01011	15/16"-27 male thread 2.2 gpm	25/600
A01012	55/64"-27 female thread 2.2 gpm	25/600
A01013	Dual threads 2.2 gpm (15/16"-27 male x 55/64"-27 female)	25/600
A01050	Dual threads 2.0 gpm (15/16"-27 male x 55/64"-27 female)	25/600
A01051	Dual threads 1.5 gpm (15/16"-27 male x 55/64"-27 female)	25/600

Non-Slotted Reduced Flow Aerator



- 0.5 gpm
- Individually bagged
- Lead Free

PART NO.	DESCRIPTION	CTN/MSTR
A01037	Dual thread (15/16"-27 male x 55/64"-27 female)	25/600

Chicago Style Faucet Aerator



- Individually bagged
- Lead Free

PART NO.	DESCRIPTION	CTN/MSTR
A01062	Non-slotted full flow (55/64"-27 female thread)	1/600

Aerator Six Pack Tubes for Counter Display



Six Aerators per Tube

- Dual threads are 15/16"-27 male x 55/64"-27 female
- Six aerators per tube; priced per display
- Lead Free

PART NO.	DESCRIPTION	CTN/MSTR
A01020	Slotted full flow (A01003)	Tube of 6/200
A01021	Slotted 2.2 gpm (A01004)	Tube of 6/200
A01022	Non-slotted full flow (A01010)	Tube of 6/200
A01023	Non-slotted 2.2 gpm (A01013)	Tube of 6/200
A01061	Non-slotted 2.0 gpm (A01050)	Tube of 6/200

Aerator Counter Display



Display

- Dual threads are 15/16"-27 male x 55/64"-27 female
- 24 tubes per display box, six aerators per tube
- 144 pieces per display; priced per display
- Lead Free

PART NO.	DESCRIPTION	CTN/MSTR
A01015	Slotted full flow (A01003)	1/5
A01016	Slotted 2.2 gpm (A01004)	1/5
A01017	Non-slotted full flow (A01010)	1/5
A01018	Non-slotted 2.2 gpm (A01013)	1/5
A01060	Non-slotted 2.0 gpm (A01050)	1/5

Spring-Flo Faucet Aerator



- Dual thread
- Fully compliant with California AB1953 and Vermont S152
- Lead Free

MADE IN THE **USA**

PART NO.	DESCRIPTION	CTN QTY
A01900	Slotted 2.2 gpm Spring-Flo display	Tube of 6/24
A01901	Slotted 2.2 gpm Spring-Flo	Tube of 6/1

Snap Fitting



A01029



A01036

- Aerated
- 2.5 gpm

PART NO.	DESCRIPTION	CTN/MSTR
A01029	Dual thread (15/16"-27 male x 55/64"-27 female x aerated snap fitting)	1/300
A01036	Nonplated brass snap coupler x 3/4" GHT for use with A01029 as a quick-disconnect unit	1/300

Swivel Spray Aerator



- Brass coupling nut
- Unit reverts to non-splash mode when water is turned off
- 2.2 gpm; 60 psi
- Individually bagged

PART NO.	DESCRIPTION	CTN/MSTR
A01014	Dual thread (15/16"-27 male x 55/64"-27 female)	12/72

Vandal-Proof Aerators



Male



Female

- Special key wrench included
- Prevents unauthorized removal

PART NO.	DESCRIPTION	CTN/MSTR
A01024	15/16"-27 male full flow	1/600
A01026	15/16"-27 male 2.0 gpm	1/600
A01027	55/64"-27 female 2.0 gpm	1/25

Faucet To Garden Hose Adapters



- Chrome plated brass
- Lead Free

PART NO.	DESCRIPTION	CTN/MSTR
A01040	Dual threads 15/16"-27 male x 55/64"- 27 female x 3/4" MGH	1/600
A01041	Dual threads 15/16"-27 male x 55/64"- 27 female x 3/4" MGH and 55/64"-27 male	1/600

Faucet Adapters



A01030



A01032

- These parts are not OEM



A01033



A01035

To Fit Delta*, American Standard* Style

PART NO.	DESCRIPTION	CTN/MSTR
A01030	CP brass 15/16"-27 male x 55/64"-27 male threads	1/25
A01031	Plastic 15/16"-27 male x 55/64"-27 male threads	1/300

To Fit Price Pfister*, Kohler* Style

PART NO.	DESCRIPTION	CTN/MSTR
A01032	CP brass female 3/4"-27 x 55/64"-27 male threads	1/300

To Fit Kohler*, Union*, Savoy* Style

PART NO.	DESCRIPTION	CTN/MSTR
A01033	CP brass male 13/16"-27 x 55/64"-27 male threads	1/300
A01034	Plastic male 13/16"-27 x 55/64"-27 male threads	1/500

To Fit Chicago* Style

PART NO.	DESCRIPTION	CTN/MSTR
A01035	CP brass female 13/16"-24 x 55/64"-27 male threads	1/500

* The manufacturers' names are used only to describe whose products the products will fit.

Fit-All Replacement Handles



Cross Pattern



Lever Pattern



Acrylic

- Vise grip design allows units to fit all types of stems, including rounded
- Each pair individually bagged

PART NO.	DESCRIPTION	CTN/MSTR
H54001	Cross pattern	5/100
H54002	Lever pattern	5/100
H54003	Acrylic	5/100



C384



C406



New!

PART NO.	DESCRIPTION	CTN/MSTR
C384	Chrome Plated hot & cold handles for compression tub/shower faucets (Pair)	6/72
C382	Chrome Plated diverter handle for tub/shower faucet	6/72
C406	Chrome Plated H & C handles for heavy tub/shower (Pair)	6/72
C406A	Chrome Plated diverter handle for heavy tub/shower	6/72

Delta*/Peerless* Replacement Handles



H54010



H54011



H54012

• Includes button and screw

PART NO.	DESCRIPTION	CTN/MSTR
H54010	Single lever crystal handle for all lav faucets using 212* ball	1/5
H54011	Single lever crystal handle offset broach for tub and shower valves using 212* ball	1/5
H54012	Single lever crystal tub handle for Scald Guard*	1/5

* The manufacturers' names are used only to describe whose products the products will fit.



H54013



H54014



H54015

• Includes button and screws

PART NO.	DESCRIPTION	CTN/MSTR
H54013	Two chrome plated canopy handles for center set	1/5
H54014	Two crystal handles for center set new style	1/5
H54015	Two crystal handles for wide spread lav and tub and shower valves	1/5

* The manufacturers' names are used only to describe whose products the products will fit.

Mixet* Replacement Handles



H54017



H54018

• Includes screw

PART NO.	DESCRIPTION	CTN/MSTR
H54017	Clear outer handle (MRH-CLR*)	1/5
H54018	Clear inner handle (MTH-CLR*)	1/5

* The manufacturers' names are used only to describe whose products the products will fit.

Valley*/Aqualine*/Eljer*/Sears* Replacement Handles



• New style crystal handle
• Complete with button and screw

PART NO.	DESCRIPTION	CTN/MSTR
H54030	Crystal single handle	1/5

* The manufacturers' names are used only to describe whose products the products will fit.

Moen*/Stanadyne* Replacement Handles



H54025



H54026



H54027



H54028



H54029

• Complete with button and screw
• Teardrop* replaces both round and Teardrop* handles

PART NO.	DESCRIPTION	CTN/MSTR
H54025	Crystal Teardrop* single lav handle shallow broach	1/5
H54026	Crystal Teardrop* single tub handle deep broach	1/5
H54027	Round crystal single lav handle shallow broach	1/5
H54028	Round crystal single tub handle deep broach	1/5
H54029	Chrome plated cap and cover for single handle kitchen faucet	1/5

* The manufacturers' names are used only to describe whose products the products will fit.

Delta*/Peerless* Faucet Index Buttons



H54040



H54041

• Single handle models

PART NO.	DESCRIPTION	CTN/MSTR
H54040	Old style crystal button for lav and tub and shower valve 1" OD	5/35
H54041	New large style crystal button for lav and tub and shower valve 1-1/2" OD	5/35

* The manufacturers' names are used only to describe whose products the products will fit.

Moen*/Stanadyne* Single Handle Replacement Buttons



H54060



H54061

PART NO.	DESCRIPTION	CTN/MSTR
H54060	Button for new style Teardrop* crystal handle	1/5
H54061	Button for round crystal handle lav and tub and shower valve	1/5

* The manufacturers' names are used only to describe whose products the products will fit.

Replacement Handles for Lavatory and Kitchen Faucets



New!

PART NO.	DESCRIPTION	CTN/MSTR
660001	Chrome Plated handles for kitchen and bathroom faucets (Pair)	1/25
660011	Satin Nickel handles for kitchen and bathroom faucets (Pair)	1/25
660041	Chrome Plated single handle for bathroom faucet	1/25
660042	Satin Nickel single handle for bathroom faucet	1/25
660071	Chrome Plated single handle for kitchen faucet	1/25
660081	Satin Nickel single handle for kitchen faucet	1/25

Ceramic Cartridge for Kitchen Faucets

New!



• Plastic square-broached stem
• Stem is internally threaded for handle screw
• Marked "DL02GJ"
• Fits 1558040, 1558060, 1558061, 1558070, 1558071, 1558072, 1558020, and 1558021

PART NO.	DESCRIPTION	CTN/MSTR
660143	Replacement cartridge for kitchen	1/25

Ceramic Cartridge for Tub/Shower Faucets

New!



- Plastic square-broached stem
- Adjustable lock-nut reinforcer
- Stem is internally threaded for handle screw
- Scald guard pressure balanced
- Marked "HJ-40"
- Fits 1550221 and 1550222

PART NO.	DESCRIPTION	CTN/MSTR
1550223	Replacement cartridge for tub/shower	1/50

Stem and Seats for Two Handle Faucets

New!



- Also fits some Glacier Bay®, Premier®, and ProPlus® faucets

PART NO.	DESCRIPTION	CTN/MSTR
C1742C	Stem and seat for two handle - Cold	4/48
C1742H	Stem and seat for two handle - Hot	4/48

* The manufacturers' names are used only to describe whose products the products will fit.

Replacement Handles for Classic Faucets

New!



- Stems come together with seats

PART NO.	DESCRIPTION	CTN/MSTR
C1807A	Stainless steel ball for single handle kitchen faucet	6/144
C1809A	Stainless steel ball for single handle bathroom faucet	6/144
C1756C	Cold stem for heavy kitchen and bathroom faucet	4/48
C1756H	Hot stem for heavy kitchen and bathroom faucet	4/48
C1754CH	Stem for compression tub/shower faucet	4/48
C1757CH	Stem for heavy tub/shower faucet	4/48
C1759D	Diverter stem for compression tub/shower faucet	4/48
C1744D	Diverter stem for heavy tub/shower faucet	4/48
C1740CH	Stem, seat, and spring for washerless faucet	4/48

Poly Bagged Escutcheons



- Chrome plated steel
- 50 per bag
- CARTON QUANTITIES ONLY

PART NO.	DESCRIPTION	CTN/MSTR
E01049	1/2" CTS (5/8" O.D.)	500/2000
E01074	3/4" CTS (7/8" O.D.)	50/2000

Items marked with the Jones Stephens logo are "You Need It...We Got It" Items.

Sure Grip Escutcheons



Low Pattern



Box Pattern



Bell Pattern

- Chrome plated steel
- CARTON QUANTITIES ONLY

Low-Pattern- Copper Tube Size

PART NO.	SIZE	FLANGE OD	CTN/MSTR
E01375	3/8" CTS (1/2" OD)	2-1/2"	25/2000
E01050	1/2" CTS (5/8" OD)	2-1/2"	25/2000
E01075	3/4" CTS (7/8" OD)	2-1/2"	25/2000
E01100	1" CTS (1-1/8" OD)	2-7/8"	25/2000
E01125	1-1/4" CTS (1-3/8" OD)	2-7/8"	25/1200
E01150	1-1/2" CTS (1-5/8" OD)	2-7/8"	25/1200

Low-Pattern- Iron Pipe Size

PART NO.	SIZE	FLANGE OD	CTN/MSTR
E02375	3/8" IPS	2-1/2"	25/2000
E02050	1/2" IPS	2-1/2"	25/2000
E02075	3/4" IPS	2-1/2"	25/2000
E02100	1" IPS	2-7/8"	25/1200
E02125	1-1/4" IPS	2-7/8"	25/1200
E02150	1-1/2" IPS	3"	25/1200
E02152	1-1/2" IPS	3-1/2"	25/600
E02200	2" IPS	3-1/2"	25/1200

Low Pattern- Tubular

PART NO.	SIZE	FLANGE OD	CTN/MSTR
E03125	1-1/4" Tubular	2-7/8"	25/1200
E03150	1-1/2" Tubular	2-7/8"	25/1200
E03200	2" Tubular	3-1/2"	25/1200

Box Pattern- Tubular

PART NO.	SIZE	FLANGE OD	CTN/MSTR
E04125	1-1/4" Tubular	3"	5/300
E04150	1-1/2" Tubular	3"	5/300
E04200	2" Tubular	3"	5/300

Box Pattern- Iron Pipe Size

PART NO.	SIZE	FLANGE OD	CTN/MSTR
E05125	1-1/4" IPS	3"	5/300
E05150	1-1/2" IPS	3"	5/300

Bell Pattern- Iron Pipe Size

PART NO.	SIZE	FLANGE OD	CTN/MSTR
E06375	3/8" IPS	2-3/8"	25/1000
E06050	1/2" IPS	2-3/8"	25/1000
E06075	3/4" IPS	2-3/8"	25/1000
E06100	1" IPS	3"	25/1000
E06125	1-1/4" IPS	3"	25/1000
E06150	1-1/2" IPS	3"	25/1000

Bell Pattern- Copper Tube Size

PART NO.	SIZE	FLANGE OD	CTN/MSTR
E07025	1/4" CTS (3/8" OD)	2-3/8"	25/1000
E07375	3/8" CTS (1/2" OD)	2-3/8"	25/1000
E07050	1/2" CTS (5/8" OD)	2-3/8"	25/1000

Bell Pattern- Tubular

PART NO.	SIZE	FLANGE OD	CTN/MSTR
E08125	1-1/4" OD Tubular	3"	25/1000
E08138	1-3/8" OD Tubular	3"	25/1000
E08150	1-1/2" OD Tubular	3"	25/1000

Plastic Shallow Flange Escutcheons



- Corrosion-proof, indestructible, high-density polyethylene
- Tight fit
- CARTON QUANTITIES ONLY

Copper Tube Size

PART NO.	SIZE	COLOR	CTN/MSTR
E15375	1/2" OD (3/8" CTS)	White	50/1000
E15050	5/8" OD (1/2" CTS)	White	50/1000
E15052	5/8" OD (1/2" CTS)	Almond	50/1000
E15075	7/8" OD (3/4" CTS)	White	50/1000

Iron Pipe Size

PART NO.	SIZE	COLOR	CTN/MSTR
E16375	3/8" IPS	White	50/1000
E16050	1/2" IPS	White	50/1000
E16075	3/4" IPS	White	50/1000
E16150	1-1/2" IPS	White	50/800
E16151	1-1/2" IPS	Almond	50/800
E16200	2" IPS	White	50/800

Tubular

PART NO.	SIZE	COLOR	CTN/MSTR
E03225	1-1/4" Tubular	White	25/25
E03250	1-1/2" Tubular	White	50/300

Flexible Floor and Ceiling Plates



- Chrome plated
- CARTON QUANTITIES ONLY

Chrome Plated Plastic

PART NO.	IPS	CTS	FLANGE OD	CTN/MSTR
F06375	3/8"	1/2"	2.572	12/1080
F06050	1/2"	3/4"	2.787	12/1080
F06075	3/4"	-	2.997	12/1440
F06099	-	1"	3.077	12/1080
F06100	1"	-	3.210	12/1440
F06124	-	1-1/4"	3.308	12/1440
F06125	1-1/4"	1-1/2"	3.580	12/1200
F06150	1-1/2"	-	3.900	12/1200
F06200	2"	-	4.450	12/720
F06201	-	2"	4.205	12/720
F06250	2-1/2"	-	5.313	12/600
F06251	-	2-1/2"	4.688	12/600
F06300	3"	-	5.875	12/480
F06301	-	3"	5.375	12/240
F06351	-	3-1/2"	5.875	12/240
F06400	4"	-	6.781	12/240
F06401	-	4"	6.344	12/240
F06500	5"	-	8.531	6/240
F06600	6"	-	9.688	6/120
F06800	8"	-	13.000	6/96

White Plastic

PART NO.	IPS	CTS	FLANGE OD	CTN/MSTR
F07375	3/8"	1/2"	2.572	12/1080
F07050	1/2"	3/4"	2.787	12/1080
F07075	3/4"	-	2.997	12/1440
F07099	-	1"	3.077	12/1080
F07100	1"	-	3.210	12/1440
F07124	-	1-1/4"	3.308	12/1440
F07125	1-1/4"	1-1/2"	3.580	12/1200
F07150	1-1/2"	-	3.900	12/1200
F07200	2"	-	4.450	12/720
F07201	-	2"	4.205	12/720
F07300	3"	-	5.825	12/480

Items marked with the Jones Stephens logo are "You Need It... We Got It" Items.

Floor and Ceiling Plates



- Chrome plated
- Boxed
- CARTON QUANTITIES ONLY

Light 24 Gauge- Copper Tube Size

PART NO.	SIZE	FLANGE OD	CTN/MSTR
F01375	3/8" CTS (1/2" OD)	2-1/2"	12/576
F01050	1/2" CTS (5/8" OD)	2-5/8"	12/576
F01075	3/4" CTS (7/8" OD)	2-27/32"	12/576
F01100	1" CTS (1-1/8" OD)	3-9/32"	12/576
F01125	1-1/4" CTS (1-3/8" OD)	3-5/8"	12/576
F01150	1-1/2" CTS (1-5/8" OD)	3-15/16"	12/576

Light 24 Gauge- Iron Pipe Size

PART NO.	SIZE	FLANGE OD	CTN/MSTR
F02375	3/8" IPS	2-1/2"	12/576
F02050	1/2" IPS	2-5/8"	12/576
F02075	3/4" IPS	2-27/32"	12/576
F02100	1" IPS	3-9/32"	12/576
F02125	1-1/4" IPS	3-5/8"	12/576
F02150	1-1/2" IPS	3-15/16"	12/576
F02200	2" IPS	4-3/8"	12/576

Heavy 21 Gauge with Springs- Copper Tube Size

PART NO.	SIZE	FLANGE OD	CTN/MSTR
F03375	3/8" CTS (1/2" OD)	2-1/8"	12/480
F03050	1/2" CTS (5/8" OD)	2-7/16"	12/480
F03075	3/4" CTS (7/8" OD)	2-21/32"	12/480
F03100	1" CTS (1-1/8" OD)	2-27/32"	12/480
F03125	1-1/4" CTS (1-3/8" OD)	3-9/32"	12/240
F03150	1-1/2" CTS (1-5/8" OD)	3-5/8"	12/240
F03200	2" CTS (2-1/8" OD)	4-3/16"	12/240
F03250	2-1/2" CTS (2-5/8" OD)	4-15/16"	6/240
F03300	3" CTS (3-1/8" OD)	5-3/16"	6/240

Heavy 21 Gauge with Springs- Iron Pipe Size

PART NO.	SIZE	FLANGE OD	CTN/MSTR
F04375	3/8" IPS	2-1/2"	12/480
F04050	1/2" IPS	2-5/8"	12/480
F04075	3/4" IPS	2-27/32"	12/480
F04100	1" IPS	3-9/32"	12/480
F04125	1-1/4" IPS	3-5/8"	12/240
F04150	1-1/2" IPS	3-15/16"	12/240
F04200	2" IPS	4-3/8"	12/240
F04250	2-1/2" IPS	5-7/32"	6/120
F04300	3" IPS	5-29/32"	6/120
F04350	3-1/2" IPS	6-9/16"	6/120
F04400	4" IPS	7-3/16"	6/120
F04500	5" IPS	8-7/8"	1/60
F04600	6" IPS	10"	1/60
F04800	8" IPS	13"	1/48
F04999	10" IPS	15"	1/48

Stainless Steel Repair Cover Plates



- Polished stainless steel finish
- 1, 2 or 3 hole design to fit multitude of valves
- Easily attaches with silicone caulk; 1-hole has brackets and screw
- 7-1/4" x 13" long

PART NO.	# OF HOLES	DIAMETER	CTN/MSTR
T73815	1	5-1/8"	20/40
T73816	2	1-3/8"	20/40
T73817	3	1-3/8"	20/40
T73818	1	3-3/4"	20/40

Cover Plates

- Mirrored acrylic
- Conceals damaged/cracked tiles
- Fits all standard bath/shower fittings
- No tools required- use silicone caulk
- DO NOT use abrasive cleaners

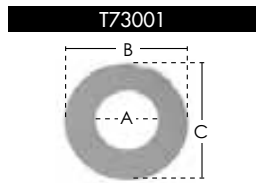

A	B	C	THICKNESS
1-11/16"	3-1/2"	3-1/2"	1/8"

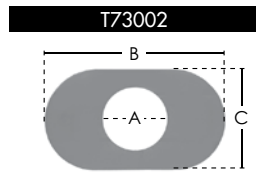

A	B	C	THICKNESS
5"	14"	8"	1/8"

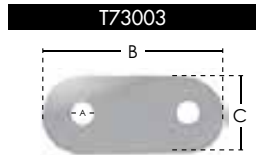

A	B	C	THICKNESS
1-3/4"	14"	6"	1/8"

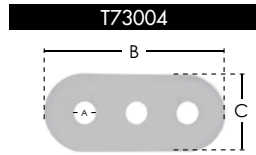

A	B	C	THICKNESS
1-3/4"	14"	6"	1/8"

PART NO.	DESCRIPTION	SIZE	CTN/MSTR
T73001	Tub spout model	3-1/2" diameter	1/300
T73002	One handle model	8" x 14"	1/100
T73003	Two handle model	6" x 14"	1/40
T73004	Three handle model	6" x 14"	1/36

Sewer Relief Valve and Cleanout

- Releases waste to outside of buildings in the event of sewer line blockage, preventing costly damage due to sewage backflow or overflow.
- Applicable in residential, commercial, or industrial settings- any structure connected to sewer lines or septic tanks
- Patent #4,475,571
- Meets ASTM specifications
- Automatic unlock and re-lock
- Vandal- resistant
- Safe in yard or high traffic areas
- Solvent welds over 4" Schedule 40 DWV pipe
- Removable lid provides full access to cleanout
- May be used to replace existing exterior cleanouts
- Easily adaptable to new or existing sewer lines
- Water and waste swirl in bowl until blockage is cleared

MADE IN THE USA

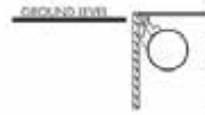

Locked in Normal Position



Opens When Overflow Occurs

PART NO.	DESCRIPTION	CTN/MSTR
S62100	PVC sewer relief valve	1/1
S62101	ABS sewer relief valve	1/1

Sewer Stopper/ Backflow Preventer



- Use inside drain line to help guard against backups
- Creates seal in pipe to reduce sewer gases
- Secures into place with set screws
- Compression fit

PART NO.	DESCRIPTION	MATERIAL	CTN/MSTR
S63200	2" sewer stopper	ZP Steel	1/100
S63300	3" sewer stopper	Brass	1/80
S63400	4" sewer stopper	Brass	1/60

Got To Have It!

Sewer Popper™ Cleanout and Relief Valve

- Automatic pop-up releases sewage overflow outside the house
- Prevents thousands of dollars in property damages
- Eliminates health hazards associated with sewage overflow
- Vandal- and tamper-resistant center
- Threaded for 3" or 4" pipe

- Constructed of white PVC
- Threaded unit can be used with PVC or ABS
- For cast iron pipe, use standard no hub clamp
- Meets Southern Building Code Section 301.10, Principle No.10
- Patent No. 5,209,257

MADE IN THE USA

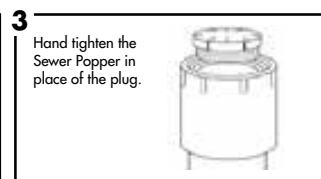
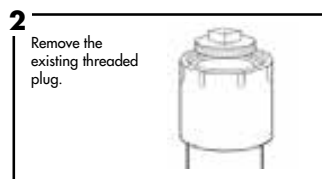
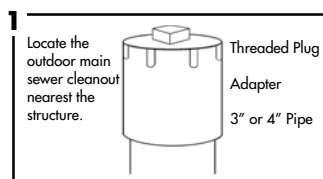

PART NO.	DESCRIPTION	CTN/MSTR
S62304	3" x 4" Sewer Popper™	1/6

Items marked with the Jones Stephens logo are "You Need It...We Got It" Items.

Flexible Stainless Steel Plumbing Connectors

Flexible Stainless Steel Plumbing Connectors

New!

S04288



B

- Reliable, trouble-free service inner core of non-toxic polymer withstands temperatures of 33°F (1°C) to 174°F (99°C)
- Leak proof seal- High quality outer braid of stainless steel and exclusive crimp-on fittings for maximum performance
- Quick and easy installation- No special tools; no soldering
- No pipe bending- Flexible connectors simplify installation, even in cramped spaces
- Chrome plated brass nut
- UPC listed
- Lead Free

- Reliable, trouble-free service inner core of non-toxic polymer withstands temperatures of 33°F (1°C) to 174°F (99°C)
- Leak proof seal- High quality outer braid of stainless steel and exclusive crimp-on fittings for maximum performance
- Quick and easy installation- No special tools; no soldering
- No pipe bending- Flexible connectors simplify installation, even in cramped spaces
- UPC listed
- Lead Free

Faucet

PART NO.	OD x FIP	LENGTH	CTN/MSTR
S04200	3/8" x 1/2"	9	25/100
S04201	3/8" x 1/2"	12	25/100
S04202	3/8" x 1/2"	16	25/100
S04203	3/8" x 1/2"	20	25/100
S04204	3/8" x 1/2"	30	25/50
S04205	3/8" x 1/2"	36	25/100
S04206	1/2" x 1/2"	12	25/100
S04207	1/2" x 1/2"	16	25/100
S04208	1/2" x 1/2"	20	25/100
S04209	1/2" x 1/2"	30	25/50
S04210	1/2" x 1/2"	36	25/100

Faucet

PART NO.	FIP x FIP	LENGTH	CTN/MSTR
S04211	1/2" x 1/2"	12	25/100
S04212	1/2" x 1/2"	16	25/175
S04213	1/2" x 1/2"	20	25/100
S04214	1/2" x 1/2"	30	25/50
S04215	1/2" x 1/2"	36	25/50

Ballcock

PART NO.	OD x BC	LENGTH	CTN/MSTR
S04216	3/8" x 7/8"	9	25/100
S04217	3/8" x 7/8"	12	25/100
S04218	3/8" x 7/8"	16	25/100
S04219	3/8" x 7/8"	20	25/100
S04220	1/2" x 7/8"	9	25/100
S04221	1/2" x 7/8"	12	25/100
S04222	1/2" x 7/8"	16	25/100
S04223	1/2" x 7/8"	20	25/100
S04255	3/8" x 7/8" w/ brass nut	12	25/100
S04288	3/8" x 7/8" w/ brass nut	20	10/50

Ballcock

PART NO.	FIP x BC	LENGTH	CTN/MSTR
S04224	1/2" x 7/8"	9	25/100
S04225	1/2" x 7/8"	12	25/100
S04226	1/2" x 7/8"	20	25/100

Ballcock

PART NO.	FLARE x BC	LENGTH	CTN/MSTR
S04280	1/2" x 7/8"	20	25/100
S04285	3/8" x 7/8"	20	25/50

Washing Machine

PART NO.	FEM HOSE x FEM HOSE	LENGTH	CTN/MSTR
S04227	3/4" x 3/4"	48	5/50
S04228	3/4" x 3/4"	60	5/175
S04229	3/4" x 3/4"	72	5/50

Icemaker

PART NO.	OD x OD	LENGTH	CTN/MSTR
S04230	1/4" x 1/4"	12	5/50
S04231	1/4" x 1/4"	60	5/50
S04232	1/4" x 1/4"	84	5/50

Items marked with the Jones Stephens logo are "You Need It...We Got It" Items.

Flexible Stainless Steel Plumbing Connectors



- Reliable, trouble-free service inner core of non-toxic polymer withstands temperatures of 33°F (1°C) to 174°F (81°C); burst pressure 1,000 PSI
- Leak proof seal- High quality outer braid of stainless steel and exclusive crimp-on fittings for maximum performance
- Quick and easy installation- No special tools; no soldering
- No pipe bending- Flexible connectors simplify installation, even in cramped spaces
- Chrome plated brass nut
- UPC listed
- Lead Free

Dishwasher with 90° Elbow

PART NO.	OD x MIP	LENGTH	CTN/MSTR
S04233	3/8" x 3/8"	48	25/50
S04234	3/8" x 3/8"	60	25/50
S04235	3/8" x 3/8"	72	25/50
S04236	1/2" x 3/8"	48	25/50
S04237	1/2" x 3/8"	60	25/50
S04238	1/2" x 3/8"	72	25/50

Dishwasher

PART NO.	OD x OD	LENGTH	CTN/MSTR
S04260	3/8" x 3/8"	48	25/50
S04268	3/8" x 3/8"	12	25/100
S04269	3/8" x 3/8"	16	25/100
S04270	3/8" x 3/8"	20	25/100

SS "Delta" Style Faucet

PART NO.	OD x COMP FITTING	LENGTH	CTN/MSTR
S04239	3/8" x 3/8"	9	25/100
S04240	3/8" x 3/8"	12	25/100
S04241	3/8" x 3/8"	16	25/100
S04242	3/8" x 3/8"	20	25/100
S04243	3/8" x 3/8"	30	25/50
S04244	3/8" x 3/8"	36	25/100

Texas Style Faucet

PART NO.	FL x OD	LENGTH	CTN/MSTR
S04245	3/8" x 3/8"	9	25/100
S04246	3/8" x 3/8"	12	25/100
S04247	3/8" x 3/8"	16	25/100
S04248	3/8" x 3/8"	20	25/100
S04249	3/8" x 3/8"	30	25/50
S04250	3/8" x 3/8"	36	25/100

Stainless Steel Dishwasher Connection with Garden Hose Fitting and 90° Elbow



- Use to connect Whirlpool*, Maytag*, Amana*, Kitchen Aid* and Jenn-Air* dishwashers manufactured after September 2009

New!
S04267

PART NO.	DESCRIPTION	CTN/MSTR
S04275	3/8" OD x 3/8" MIP x 60"	1/1
S04276	3/8" OD x 3/8" MIP x 72"	1/1
S04267	3/4" FHT x 60" with long 90° end	1/15
G20086LF	Garden Hose Ftg & 90 only - 3/4" FGHT x 3/8" OD Comp	1/1

* The manufacturers' names are used only to describe whose products the products will fit.

Braided Nylon Plumbing Connectors



- Reliable, economy style connectors
- Temperature rated 173° (82°C)
- Burst pressure is 450 PSI
- Chrome plated nut
- UPC listed
- Lead Free

Faucet

PART NO.	OD x FIP	LENGTH	CTN/MSTR
S04400	3/8" x 1/2"	9	25/100
S04401	3/8" x 1/2"	12	25/100
S04402	3/8" x 1/2"	16	25/100
S04403	3/8" x 1/2"	20	25/100
S04404	3/8" x 1/2"	30	25/50
S04405	1/2" x 1/2"	12	25/100
S04406	1/2" x 1/2"	16	25/100
S04407	1/2" x 1/2"	20	25/150
S04408	1/2" x 1/2"	30	25/100

Faucet

PART NO.	FIP x FIP	LENGTH	CTN/MSTR
S04409	1/2" x 1/2"	12	25/100
S04410	1/2" x 1/2"	16	25/100
S04411	1/2" x 1/2"	20	25/100
S04440	1/2" x 1/2"	36	25/100

Faucet

PART NO.	COMP x FIP	LENGTH	CTN/MSTR
S04450	3/8" x 1/2"	24	25/100
S04455	3/8" x 1/2"	36	25/50

Delta*

PART NO.	OD x COMP FITTING	LENGTH	CTN/MSTR
S04412	3/8" x 3/8"	12	25/100
S04413	3/8" x 3/8"	20	25/100

Toilet

PART NO.	OD x BC	LENGTH	CTN/MSTR
S04414	3/8" x 7/8"	9	25/100
S04415	3/8" x 7/8"	12	25/100
S04416	3/8" x 7/8"	16	25/100
S04417	3/8" x 7/8"	20	25/100
S04418	1/2" x 7/8"	9	25/100
S04419	1/2" x 7/8"	12	25/200
S04420	1/2" x 7/8"	16	25/100
S04421	1/2" x 7/8"	20	25/100

Toilet

PART NO.	FIP x BC	LENGTH	CTN/MSTR
S04422	1/2" x 7/8"	9	25/100
S04423	1/2" x 7/8"	12	25/100
S04424	1/2" x 7/8"	20	25/100

Dishwasher with 90° Elbow

PART NO.	OD x MIP	LENGTH	CTN/MSTR
S04430	3/8" x 3/8"	72	10/40

* The manufacturers' names are used only to describe whose products the products will fit.

PEX Supply Tube (3/8" OD)



- Rated 100 psi at 180°F
- Resistant to corrosion and damage due to freezing
- NSF listed material

PART NO.	DESCRIPTION	CTN/MSTR
S04101	3/8" x 12" Basin	10/325
S04102	3/8" x 15" Basin	10/250
S04103	3/8" x 20" Basin	10/150
S04104	3/8" x 30" Basin	10/200
S04108	3/8" x 36" Basin	10/200
S04105	3/8" x 12" Tank	10/300
S04106	3/8" x 15" Tank	10/250
S04107	3/8" x 20" Tank	10/175

PEX Supply Tube with Ferrule



- Supplied with ferrule (3/8" compression sleeve)
- Rated 100 PSI at 180°
- NSF listed material

PART NO.	DESCRIPTION	CTN/MSTR
S04121	3/8" x 12 Basin	10/100
S04123	3/8" x 20 Basin	10/100
S04124	3/8" x 30 Basin	10/100
S04128	3/8" x 36 Basin	10/100
S04125	3/8" x 12 Tank	10/100
S04127	3/8" x 20 Tank	10/100

Chrome Plated Flexible Basin Supply Tube



- Lead Free

PART NO.	DESCRIPTION	CTN/MSTR
S04020	3/8" x 12" Basin	1/500
S04021	3/8" x 16" Basin	1/400
S04022	3/8" x 20" Basin	1/300
S04023	3/8" x 30" Basin	1/200
S04024	3/8" x 36" Basin	1/200
S04025	1/2" x 12" Basin	1/200
S04026	1/2" x 20" Basin	1/200

Chrome Plated Flexible Supply Tube with Plastic Nose



- Chrome plated
- With plastic nose
- Lead Free

PART NO.	DESCRIPTION	CTN/MSTR
S04027	3/8" x 12" Tank	1/500
S04028	3/8" x 16" Tank	1/300
S04029	3/8" x 20" Tank	1/300
S04030	1/2" x 12" Tank	1/50



- Chrome plated
- With plastic nose cone
- Lead Free

PART NO.	DESCRIPTION	CTN/MSTR
S04031	3/8" x 12" Basin	1/200
S04032	3/8" x 20" Basin	1/100

Items marked with the Jones Stephens logo are "You Need It...We Got It" Items.

Chrome Plated Brass Multi-Turn Supply Stop



- cUPC listed
- Lead Free

PART NO.	DESCRIPTION	CTN/MSTR
S10338	3/8 FIP x 3/8 OD Angle	1/200
S10321	1/2 FIP x 1/4 OD Angle	1/200
S10300	1/2 FIP x 3/8 OD Angle	1/200
S10302	1/2 FIP x 3/8 OD Straight	1/200
S10323	3/8 OD x 3/8 OD Straight	1/200
S10324	5/8 OD x 1/4 OD Angle	1/200
S10301	5/8 OD x 3/8 OD Angle	1/200
S10303	5/8 OD x 3/8 OD Straight	1/200
S10316	5/8 OD x 1/2 OD Straight	1/200
S10325	1/2 Sweat x 3/8 OD Angle	1/200
S10326	1/2 Sweat x 3/8 OD Straight	1/200
S10335	1/2 PEX x 1/4 OD Angle	1/200
S10318	1/2 PEX x 3/8 OD Angle	1/200
S10337	1/2 PEX x 3/8 OD Straight	1/200
S10319	1/2 CPVC x 3/8 OD Straight	1/200
S10320	1/2 CPVC x 3/8 OD Angle	1/200

Chrome Plated Brass Quarter Turn Supply Stop



- cUPC listed
- Lead Free

PART NO.	DESCRIPTION	CTN/MSTR
S10339	3/8 FIP x 3/8 OD Angle	24/144
S10327	3/8 FIP x 3/8 OD Straight	1/200
S10328	1/2 FIP x 1/4 OD Angle	1/200
S10310	1/2 FIP x 3/8 OD Angle	1/200
S10312	1/2 FIP x 3/8 OD Straight	1/200
S10330	3/8 OD x 3/8 OD Straight	1/200
S10317	5/8 OD x 1/4 OD Angle	1/200
S10311	5/8 OD x 3/8 OD Angle	1/200
S10313	5/8 OD x 3/8 OD Straight	1/200
S10331	1/2 Sweat x 3/8 OD Angle	1/200
S10332	1/2 Sweat x 3/8 OD Straight	1/200
S10333	5/8 OD x 3/8 OD x 3/8 OD Dual	1/200
S10334	5/8 OD x 3/8 OD x 1/4 OD Dual	1/200
S10336	1/2 PEX x 1/4 OD Angle	1/150
S10314	1/2 PEX x 3/8 OD Angle	1/144
S10315	1/2 PEX x 3/8 OD Straight	1/144
S10340	1/2 x 3/8 OD Angle Wirsbo® style	10/200
S10341	1/2 x 3/8 OD Straight Wirsbo® style	10/200

Rough Brass Easy Connect Tee



- Brass
- Attaches to outlet of stop valve to give you 2 outlets
- Lead Free

PART NO.	DESCRIPTION	CTN/MSTR
C74250LF	3/8" F Comp x 3/8" M Comp x 3/8" M Comp	5/25
C74251LF	3/8" F Comp x 3/8" M Comp x 1/4" M Comp	5/25

Chrome Plated Quarter Turn Repair Stop Valve



- Attach to outlet of broken valve to give you another valve
- AB1953 compliant
- Lead Free

PART NO.	DESCRIPTION	CTN/MSTR
S10355	3/8" F Comp x 3/8" M Comp x 3/8" M Comp	5/25

Standard Utility Sink



- Polypropylene sink with legs
- Drain stopper and strainer
- Leg levelers
- Stain and rust resistant
- Self-draining, built-in soap dishes
- Faucet not included
- Sink dimensions: 22-3/4" x 25-1/4" x 32"



PART NO.	DESCRIPTION	CTN/MSTR
M60001	19 gallon white standard utility sink	1/6

Drop-In Utility Sink



- ABS sink with no legs
- Large capacity and integrated wash board
- Installation hardware included
- Lightweight self-rim design for easy countertop installation
- Pre-molded faucet holes (4" center set)
- Faucet not included
- Sink dimensions: 25" x 22" x 14-1/2"



PART NO.	DESCRIPTION	CTN/MSTR
M60002	14.5 gallon white drop-in utility sink	1/4

Heavy Duty Utility Sink



- Polypropylene sink with legs
- Drain stopper and strainer
- Leg levelers
- Stain and rust resistant
- Pre-molded faucet holes (4" center set)
- Faucet not included
- Sink dimensions: 23-3/4" x 24-3/4" x 32-1/2"



PART NO.	DESCRIPTION	CTN/MSTR
M60003	20 gallon white heavy duty utility sink	1/4

Cross Handle Self Closing Valve



- Chrome plated
- Heavy brass construction

PART NO.	DESCRIPTION	CTN/MSTR
S05105	1/2" FIP self closing valve	25/50

Cross Handle Self Closing Valve



- Chrome plated
- Heavy brass construction

PART NO.	DESCRIPTION	CTN/MSTR
S05105	1/2" FIP self closing valve	25/50

Cross Handle Self Closing Valve



- Chrome plated
- Heavy brass construction

PART NO.	DESCRIPTION	CTN/MSTR
S05105	1/2" FIP self closing valve	25/50

Chrome Plated Single Sink Bibb



- Chrome plated bodies and tee handles
- Replaceable washers

PART NO.	INLET	FLANGE	CTN/MSTR
S08003	1/2" FIP	Fixed (3/4" hose outlet)	12/72

Wall Mount Sink Faucet



- Chrome plated with soap dish mounted on body
- 8" center to center
- Adjustable 1/2" female threaded eccentric couplings
- Replaceable seats and stems
- Meets NSF standard 61.9
- Lead Free

PART NO.	DESCRIPTION	CTN/MSTR
S08008	8" tubular spout	1/12
S08012	12" tubular spout	1/12
S08030	Hot repair kit (handle, stem and seat)	1/100
S08031	Cold repair kit (handle, stem and seat)	1/100
S08032	Union repair kit (union assembly)	1/50

Laundry Tray Faucet



A01006

- Supplied with garden hose adapter and A01006 aerator
- Can be used either way with either adapter or aerator
- Meets Detroit Code
- Lead Free

PART NO.	DESCRIPTION	CTN/MSTR
L47001	Chrome laundry tray faucet	1/24
L47004	With gooseneck spout	1/24

Basin Faucet



Heavy Pattern



Standard Pattern

- Chrome plated
- Replaceable seats and stems
- Furnished with hot and cold buttons
- Meets NSF standard 61.9
- Lead Free

PART NO.	DESCRIPTION	CTN/MSTR
F39001	Heavy pattern with aerator	1/30
F39002	Standard pattern	1/50
F39004	Repair kit for F39002 series (Handle, seat, stem and buttons)	1/100
F39005	Repair kit for F39001 series (Handles, seat, stem and buttons)	1/150

Self-Closing Basin Faucet and Shower Valve



Self-Closing Basin Faucet



Shower Valve with Pull Chain

- Chrome plated heavy duty pattern
- Deluxe aerator
- 1/2" FIP connection
- Replaceable stem, cam and spring mechanism
- Shower valves ideal for urinals when used with standpipe assembly

PART NO.	DESCRIPTION	CTN/MSTR
F39010	Basin faucet	1/36
S05100	Shower valve with pull chain (7" chain)	1/50
S05102	Tailpiece assembly for S05100 with nut and flange	1/100
S05101	Repair kit (stem and cam mechanism)	1/10

Service Sink Faucet



Lever Handles



Cross Handles



S55352

- Integral stops; 1/4 turn for S55349
- Complete with all mounting hardware
- Integrated vacuum breaker (ASSE 1001)
- Front hook to hang bucket

PART NO.	DESCRIPTION	CTN/MSTR
S55349	Service sink faucet with lever handles	1/8
S55350	Service sink faucet with cross handles	1/6
S55352	Lever handle and stem repair kit S55349	1/50
S55353	Integral stop repair kit for S55350	1/100
S55354	Vacuum breaker repair kit for S55350	1/100

Hose and Hose Bracket for Service Sink



- Heavy duty 300 PSI cloth-reinforced hose
- 3/4" brass hose coupling at one end
- 5" x 3" stainless steel bracket with rubber grips

PART NO.	DESCRIPTION	CTN/MSTR
M05001	30" hose with bracket	1/1
M05005	Bracket only	1/100

Mop Hanger for Service Sink

- 24" x 3" stainless steel hanger with three rubber tool grips
- Anchors included



PART NO.	DESCRIPTION	CTN/MSTR
M05003	Mop hanger	1/25

Drinking Fountain Bubbler and Cartridge



- Chrome plated brass body
- 3/8" FIP connection
- Stainless steel cartridge
- Lead Free

PART NO.	DESCRIPTION	CTN/MSTR
B45215	CP brass bubbler with stainless steel cartridge	1/40
B45216	Stainless steel replacement cartridge	100/500

Drinking Fountain Bubbler with Face Guard



Flexible Water Shield

- Chrome plated brass body
- Equipped with unique neo-poly water shield to prevent injuries to teeth, gums and face
- Tamper proof design requires 5/16" hex key to remove/ replace water shield for cleaning
- B45218 Kit includes new water shield, washer, and retainer nut
- Lead Free

PART NO.	DESCRIPTION	CTN/MSTR
B45216	Stainless steel replacement cartridge	100/500
B45217	Chrome plated brass bubbler	1/40
B45218	Polymer water shield kit	1/120

Self-Closing Drinking Fountain



- Chrome plated brass
- Mildew resistant
- Perfect for schools
- Stainless steel cartridge
- 1/2" Female pipe threads
- Lead Free

PART NO.	DESCRIPTION	CTN/MSTR
B45200	Drinking fountain	1/25

Retrofit Bubbler Kit



- Replaces fountain on china fixtures
- Contains bubbler 1/2" x 3/8" x 3-1/2" nipple, rosette flange, locknut, coupling nut and 1-3/4" faucet cover
- All metal
- Lead Free

PART NO.	DESCRIPTION	CTN/MSTR
B45220	Drinking fountain	1/20

Items marked with the Jones Stephens logo are "You Need It...We Got It" Items.

3/8" OD Uncoated with Fittings



- Durable stainless steel 304
- Corrugation extends all the way to the fitting for increased tubing flexibility
- CSA Design certified domestically and internationally for indoor and outdoor use
- 100% leak tested to ensure safety and quality and a product you can trust
- Quality flared end fittings to create a metal to metal seal in critical applications
- Corrosion resistant

PART NO.	DESCRIPTION	CTN/MSTR
G70000	1/2" MIP x 1/2" MIP x 12"	1/25
G70001	1/2" FIP x 1/2" FIP x 12"	1/25
G70002	3/8" FIP x 3/8" FIP x 12"	1/25
G70003	1/2" FIP x 1/2" MIP x 12"	1/25
G70004	1/2" FIP x 3/8" MIP x 12"	1/25
G70005	3/8" FIP x 1/2" MIP x 12"	1/25
G70006	3/8" FIP x 3/8" MIP x 12"	1/25
G70007	1/2" MIP x 1/2" MIP x 18"	1/25
G70008	1/2" FIP x 1/2" FIP x 18"	1/25
G70009	3/8" FIP x 3/8" FIP x 18"	1/25
G70010	1/2" FIP x 1/2" MIP x 18"	1/25
G70011	1/2" FIP x 3/8" MIP x 18"	1/25
G70012	3/8" FIP x 1/2" MIP x 18"	1/25
G70013	3/8" FIP x 3/8" MIP x 18"	1/25
G70014	1/2" MIP x 1/2" MIP x 24"	1/25
G70015	1/2" FIP x 1/2" FIP x 24"	1/25
G70016	3/8" FIP x 3/8" FIP x 24"	1/25
G70017	1/2" FIP x 1/2" MIP x 24"	1/25
G70018	1/2" FIP x 3/8" MIP x 24"	1/25
G70019	3/8" FIP x 1/2" MIP x 24"	1/25
G70020	3/8" FIP x 3/8" MIP x 24"	1/25
G70021	1/2" MIP x 1/2" MIP x 30"	1/25
G70022	1/2" FIP x 1/2" FIP x 30"	1/25
G70023	3/8" FIP x 3/8" FIP x 30"	1/25
G70024	1/2" FIP x 1/2" MIP x 30"	1/25
G70025	1/2" FIP x 3/8" MIP x 30"	1/25
G70026	3/8" FIP x 1/2" MIP x 30"	1/25
G70027	3/8" FIP x 3/8" MIP x 30"	1/25
G70028	1/2" MIP x 1/2" MIP x 36"	1/25
G70029	1/2" FIP x 1/2" FIP x 36"	1/25
G70030	3/8" FIP x 3/8" FIP x 36"	1/25
G70031	1/2" FIP x 1/2" MIP x 36"	1/25
G70032	1/2" FIP x 3/8" MIP x 36"	1/25
G70033	3/8" FIP x 1/2" MIP x 36"	1/25
G70034	3/8" FIP x 3/8" MIP x 36"	1/25
G70035	1/2" MIP x 1/2" MIP x 48"	1/25
G70036	1/2" FIP x 1/2" FIP x 48"	1/25
G70037	3/8" FIP x 3/8" FIP x 48"	1/25
G70038	1/2" FIP x 1/2" MIP x 48"	1/25
G70039	1/2" FIP x 3/8" MIP x 48"	1/25
G70040	3/8" FIP x 1/2" MIP x 48"	1/25
G70041	3/8" FIP x 3/8" MIP x 48"	1/25
G70042	1/2" MIP x 1/2" MIP x 60"	1/25
G70043	1/2" FIP x 1/2" FIP x 60"	1/25
G70044	3/8" FIP x 3/8" FIP x 60"	1/25
G70045	1/2" FIP x 1/2" MIP x 60"	1/25

3/8" OD Uncoated with Fittings (cont.)



- Durable stainless steel 304
- Corrugation extends all the way to the fitting for increased tubing flexibility
- CSA Design certified domestically and internationally for indoor and outdoor use
- 100% leak tested to ensure safety and quality and a product you can trust
- Quality flared end fittings to create a metal to metal seal in critical applications
- Corrosion resistant

PART NO.	DESCRIPTION	CTN/MSTR
G70046	1/2" FIP x 3/8" MIP x 60"	1/25
G70047	3/8" FIP x 1/2" MIP x 60"	1/25
G70048	3/8" FIP x 3/8" MIP x 60"	1/25
G70049	1/2" MIP x 1/2" MIP x 72"	1/25
G70050	1/2" FIP x 1/2" FIP x 72"	1/25
G70051	3/8" FIP x 3/8" FIP x 72"	1/25
G70052	1/2" FIP x 1/2" MIP x 72"	1/25
G70053	1/2" FIP x 3/8" MIP x 72"	1/25
G70054	3/8" FIP x 1/2" MIP x 72"	1/25
G70055	3/8" FIP x 3/8" MIP x 72"	1/25

3/8" OD Yellow Coated with Fittings



- Durable stainless steel 304
- Corrugation extends all the way to the fitting for increased tubing flexibility
- CSA Design certified domestically and internationally for indoor and outdoor use
- 100% leak tested to ensure safety and quality and a product you can trust
- Quality flared end fittings to create a metal to metal seal in critical applications
- Coated connectors add additional safety in highly corrosive environments or in areas where caustic chemicals are located
- Corrosion resistant

PART NO.	DESCRIPTION	CTN/MSTR
G70100	1/2" MIP x 1/2" MIP x 12"	1/25
G70101	1/2" FIP x 1/2" FIP x 12"	1/25
G70102	3/8" FIP x 3/8" FIP x 12"	1/25
G70103	1/2" FIP x 1/2" MIP x 12"	1/25
G70104	1/2" FIP x 3/8" MIP x 12"	1/25
G70105	3/8" FIP x 1/2" MIP x 12"	1/25
G70106	3/8" FIP x 3/8" MIP x 12"	1/25
G70107	1/2" MIP x 1/2" MIP x 18"	1/25
G70108	1/2" FIP x 1/2" FIP x 18"	1/25
G70109	3/8" FIP x 3/8" FIP x 18"	1/25
G70110	1/2" FIP x 1/2" MIP x 18"	1/25
G70111	1/2" FIP x 3/8" MIP x 18"	1/25
G70112	3/8" FIP x 1/2" MIP x 18"	1/25
G70113	3/8" FIP x 3/8" MIP x 18"	1/25
G70114	1/2" MIP x 1/2" MIP x 24"	1/25
G70115	1/2" FIP x 1/2" FIP x 24"	1/25
G70116	3/8" FIP x 3/8" FIP x 24"	1/25
G70117	1/2" FIP x 1/2" MIP x 24"	1/25
G70118	1/2" FIP x 3/8" MIP x 24"	1/25
G70119	3/8" FIP x 1/2" MIP x 24"	1/25
G70120	3/8" FIP x 3/8" MIP x 24"	1/25
G70121	1/2" MIP x 1/2" MIP x 30"	1/25
G70122	1/2" FIP x 1/2" FIP x 30"	1/25

3/8" OD Yellow Coated with Fittings (cont.)



- Durable stainless steel 304
- Corrugation extends all the way to the fitting for increased tubing flexibility
- CSA Design certified domestically and internationally for indoor and outdoor use
- 100% leak tested to ensure safety and quality and a product you can trust
- Quality flared end fittings to create a metal to metal seal in critical applications
- Coated connectors add additional safety in highly corrosive environments or in areas where caustic chemicals are located
- Corrosion resistant

B

PART NO.	DESCRIPTION	CTN/MSTR
G70123	3/8" FIP x 3/8" FIP x 30"	1/25
G70124	1/2" FIP x 1/2" MIP x 30"	1/25
G70125	1/2" FIP x 3/8" MIP x 30"	1/25
G70126	3/8" FIP x 1/2" MIP x 30"	1/25
G70127	3/8" FIP x 3/8" MIP x 30"	1/25
G70128	1/2" MIP x 1/2" MIP x 36"	1/25
G70129	1/2" FIP x 1/2" FIP x 36"	1/25
G70130	3/8" FIP x 3/8" FIP x 36"	1/25
G70131	1/2" FIP x 1/2" MIP x 36"	1/25
G70132	1/2" FIP x 3/8" MIP x 36"	1/25
G70133	3/8" FIP x 1/2" MIP x 36"	1/25
G70134	3/8" FIP x 3/8" MIP x 36"	1/25
G70135	1/2" MIP x 1/2" MIP x 48"	1/25
G70136	1/2" FIP x 1/2" FIP x 48"	1/25
G70137	3/8" FIP x 3/8" FIP x 48"	1/25
G70138	1/2" FIP x 1/2" MIP x 48"	1/25
G70139	1/2" FIP x 3/8" MIP x 48"	1/25
G70140	3/8" FIP x 1/2" MIP x 48"	1/25
G70141	3/8" FIP x 3/8" MIP x 48"	1/25
G70142	1/2" MIP x 1/2" MIP x 60"	1/25
G70143	1/2" FIP x 1/2" FIP x 60"	1/25
G70144	3/8" FIP x 3/8" FIP x 60"	1/25
G70145	1/2" FIP x 1/2" MIP x 60"	1/25
G70146	1/2" FIP x 3/8" MIP x 60"	1/25
G70147	3/8" FIP x 1/2" MIP x 60"	1/25
G70148	3/8" FIP x 3/8" MIP x 60"	1/25
G70149	1/2" MIP x 1/2" MIP x 72"	1/25
G70150	1/2" FIP x 1/2" FIP x 72"	1/25
G70151	3/8" FIP x 3/8" FIP x 72"	1/25
G70152	1/2" FIP x 1/2" MIP x 72"	1/25
G70153	1/2" FIP x 3/8" MIP x 72"	1/25
G70154	3/8" FIP x 1/2" MIP x 72"	1/25
G70155	3/8" FIP x 3/8" MIP x 72"	1/25

3/8" OD Uncoated with Ball Valve



- Durable stainless steel 304
- Corrugation extends all the way to the fitting for increased tubing flexibility
- CSA Design certified domestically and internationally for indoor and outdoor use
- 100% leak tested to ensure safety and quality and a product you can trust
- Quality flared end fittings to create a metal to metal seal in critical applications
- Corrosion resistant

PART NO.	DESCRIPTION	CTN/MSTR
G70200	3/8" MIP x 1/2" FIP Ball x 12"	1/25
G70201	1/2" MIP x 1/2" FIP Ball x 12"	1/25
G70203	3/8" FIP x 1/2" FIP Ball x 12"	1/25
G70205	1/2" MIP x 1/2" FIP Ball x 18"	1/25
G70206	1/2" FIP x 1/2" FIP Ball x 18"	1/25
G70207	3/8" FIP x 1/2" FIP Ball x 18"	1/25
G70208	3/8" MIP x 1/2" FIP Ball x 24"	1/25
G70209	1/2" MIP x 1/2" FIP Ball x 24"	1/25
G70210	1/2" FIP x 1/2" FIP Ball x 24"	1/25
G70211	3/8" FIP x 1/2" FIP Ball x 24"	1/25
G70212	3/8" MIP x 1/2" FIP Ball x 30"	1/25
G70213	1/2" MIP x 1/2" FIP Ball x 30"	1/25
G70214	1/2" FIP x 1/2" FIP Ball x 30"	1/25
G70215	3/8" FIP x 1/2" FIP Ball x 30"	1/25
G70216	3/8" MIP x 1/2" FIP Ball x 36"	1/25
G70217	1/2" MIP x 1/2" FIP Ball x 36"	1/25
G70218	1/2" FIP x 1/2" FIP Ball x 36"	1/25
G70219	3/8" FIP x 1/2" FIP Ball x 36"	1/25
G70220	3/8" MIP x 1/2" FIP Ball x 48"	1/25
G70221	1/2" MIP x 1/2" FIP Ball x 48"	1/25
G70222	1/2" FIP x 1/2" FIP Ball x 48"	1/25
G70223	3/8" FIP x 1/2" FIP Ball x 48"	1/25
G70224	3/8" MIP x 1/2" FIP Ball x 60"	1/25
G70225	1/2" MIP x 1/2" FIP Ball x 60"	1/25
G70226	1/2" FIP x 1/2" FIP Ball x 60"	1/25
G70227	3/8" FIP x 1/2" FIP Ball x 60"	1/25
G70228	3/8" MIP x 1/2" FIP Ball x 72"	1/25
G70229	1/2" MIP x 1/2" FIP Ball x 72"	1/25
G70230	1/2" FIP x 1/2" FIP Ball x 72"	1/25
G70231	3/8" FIP x 1/2" FIP Ball x 72"	1/25
G70232	1/2" MIP x 1/2" FIP Angle Ball x 48"	1/25
G70233	3/8" FIP x 1/2" FIP Angle Ball x 48"	1/25
G70234	1/2" MIP x 1/2" FIP Angle Ball x 60"	1/25
G70235	3/8" FIP x 1/2" FIP Angle Ball x 60"	1/25
G70236	1/2" MIP x 1/2" FIP Angle Ball x 72"	1/25
G70237	3/8" FIP x 1/2" FIP Angle Ball x 72"	1/25

5/8" OD Uncoated with Fittings



- Durable stainless steel 304
- Corrugation extends all the way to the fitting for increased tubing flexibility
- CSA Design certified domestically and internationally for indoor and outdoor use
- 100% leak tested to ensure safety and quality and a product you can trust
- Quality flared end fittings to create a metal to metal seal in critical applications
- Corrosion resistant

PART NO.	DESCRIPTION	CTN/MSTR
G71000	3/4" MIP x 3/4" MIP x 12"	1/25
G71001	3/4" MIP x 1/2" MIP x 12"	1/25
G71002	1/2" MIP x 1/2" MIP x 12"	1/25
G71003	3/4" FIP x 3/4" FIP x 12"	1/25
G71004	3/4" FIP x 1/2" FIP x 12"	1/25
G71005	1/2" FIP x 1/2" FIP x 12"	1/25
G71006	1/2" FIP x 3/4" MIP x 12"	1/25
G71007	3/4" FIP x 3/4" MIP x 12"	1/25
G71008	3/4" FIP x 1/2" MIP x 12"	1/25
G71009	1/2" FIP x 1/2" MIP x 12"	1/25
G71010	3/4" MIP x 3/4" MIP x 18"	1/25
G71011	3/4" MIP x 1/2" MIP x 18"	1/25
G71012	1/2" MIP x 1/2" MIP x 18"	1/25
G71013	3/4" FIP x 3/4" FIP x 18"	1/25
G71014	3/4" FIP x 1/2" FIP x 18"	1/25
G71015	1/2" FIP x 1/2" FIP x 18"	1/25
G71016	1/2" FIP x 3/4" MIP x 18"	1/25
G71017	3/4" FIP x 3/4" MIP x 18"	1/25
G71018	3/4" FIP x 1/2" MIP x 18"	1/25
G71019	1/2" FIP x 1/2" MIP x 18"	1/25
G71020	3/4" MIP x 3/4" MIP x 24"	1/25
G71021	3/4" MIP x 1/2" MIP x 24"	1/25
G71022	1/2" MIP x 1/2" MIP x 24"	1/25
G71023	3/4" FIP x 3/4" FIP x 24"	1/25
G71024	3/4" FIP x 1/2" FIP x 24"	1/25
G71025	1/2" FIP x 1/2" FIP x 24"	1/25
G71026	1/2" FIP x 3/4" MIP x 24"	1/25
G71027	3/4" FIP x 3/4" MIP x 24"	1/25
G71028	3/4" FIP x 1/2" MIP x 24"	1/25
G71029	1/2" FIP x 1/2" MIP x 24"	1/25
G71031	3/4" MIP x 1/2" MIP x 30"	1/25
G71032	1/2" MIP x 1/2" MIP x 30"	1/25
G71033	3/4" FIP x 3/4" FIP x 30"	1/25
G71034	3/4" FIP x 1/2" FIP x 30"	1/25
G71035	1/2" FIP x 1/2" FIP x 30"	1/25
G71036	1/2" FIP x 3/4" MIP x 30"	1/25
G71037	3/4" FIP x 3/4" MIP x 30"	1/25
G71038	3/4" FIP x 1/2" MIP x 30"	1/25
G71039	1/2" FIP x 1/2" MIP x 30"	1/25
G71040	3/4" MIP x 3/4" MIP x 36"	1/25
G71041	3/4" MIP x 1/2" MIP x 36"	1/25
G71042	1/2" MIP x 1/2" MIP x 36"	1/25
G71043	3/4" FIP x 3/4" FIP x 36"	1/25
G71044	3/4" FIP x 1/2" FIP x 36"	1/25
G71045	1/2" FIP x 1/2" FIP x 36"	1/25

5/8" OD Uncoated with Fittings (cont.)



- Durable stainless steel 304
- Corrugation extends all the way to the fitting for increased tubing flexibility
- CSA Design certified domestically and internationally for indoor and outdoor use
- 100% leak tested to ensure safety and quality and a product you can trust
- Quality flared end fittings to create a metal to metal seal in critical applications
- Corrosion resistant

PART NO.	DESCRIPTION	CTN/MSTR
G71046	1/2" FIP x 3/4" MIP x 36"	1/25
G71047	3/4" FIP x 3/4" MIP x 36"	1/25
G71048	3/4" FIP x 1/2" MIP x 36"	1/25
G71049	1/2" FIP x 1/2" MIP x 36"	1/25
G71050	3/4" MIP x 3/4" MIP x 48"	1/25
G71051	3/4" MIP x 1/2" MIP x 48"	1/25
G71052	1/2" MIP x 1/2" MIP x 48"	1/25
G71053	3/4" FIP x 3/4" FIP x 48"	1/25
G71054	3/4" FIP x 1/2" FIP x 48"	1/25
G71055	1/2" FIP x 1/2" FIP x 48"	1/25
G71056	1/2" FIP x 3/4" MIP x 48"	1/25
G71057	3/4" FIP x 3/4" MIP x 48"	1/25
G71058	3/4" FIP x 1/2" MIP x 48"	1/25
G71059	1/2" FIP x 1/2" MIP x 48"	1/25
G71060	3/4" MIP x 3/4" MIP x 60"	1/25
G71061	3/4" MIP x 1/2" MIP x 60"	1/25
G71062	1/2" MIP x 1/2" MIP x 60"	1/25
G71063	3/4" FIP x 3/4" FIP x 60"	1/25
G71064	3/4" FIP x 1/2" FIP x 60"	1/25
G71066	1/2" FIP x 3/4" MIP x 60"	1/25
G71067	3/4" FIP x 3/4" MIP x 60"	1/25
G71068	3/4" FIP x 1/2" MIP x 60"	1/25
G71069	1/2" FIP x 1/2" MIP x 60"	1/25
G71070	3/4" MIP x 3/4" MIP x 72"	1/25
G71071	3/4" MIP x 1/2" MIP x 72"	1/25
G71072	1/2" MIP x 1/2" MIP x 72"	1/25
G71074	3/4" FIP x 1/2" FIP x 72"	1/25
G71075	1/2" FIP x 1/2" FIP x 72"	1/25
G71076	1/2" FIP x 3/4" MIP x 72"	1/25
G71077	3/4" FIP x 3/4" MIP x 72"	1/25
G71078	3/4" FIP x 1/2" MIP x 72"	1/25
G71079	1/2" FIP x 1/2" MIP x 72"	1/25

B

5/8" OD Yellow Coated with Fittings



- Durable stainless steel 304
- Corrugation extends all the way to the fitting for increased tubing flexibility
- CSA Design certified domestically and internationally for indoor and outdoor use
- 100% leak tested to ensure safety and quality and a product you can trust
- Quality flared end fittings to create a metal to metal seal in critical applications
- Coated connectors add additional safety in highly corrosive environments or in areas where caustic chemicals are located
- Corrosion resistant

B

PART NO.	DESCRIPTION	CTN/MSTR
G71100	3/4" MIP x 3/4" MIP x 12"	1/25
G71102	1/2" MIP x 1/2" MIP x 12"	1/25
G71103	3/4" FIP x 3/4" FIP x 12"	1/25
G71104	3/4" FIP x 1/2" FIP x 12"	1/25
G71105	1/2" FIP x 1/2" FIP x 12"	1/25
G71106	1/2" FIP x 3/4" MIP x 12"	1/25
G71107	3/4" FIP x 3/4" MIP x 12"	1/25
G71108	3/4" FIP x 1/2" MIP x 12"	1/25
G71109	1/2" FIP x 1/2" MIP x 12"	1/25
G71110	3/4" MIP x 3/4" MIP x 18"	1/25
G71111	3/4" MIP x 1/2" MIP x 18"	1/25
G71112	1/2" MIP x 1/2" MIP x 18"	1/25
G71113	3/4" FIP x 3/4" FIP x 18"	1/25
G71114	3/4" FIP x 1/2" FIP x 18"	1/25
G71115	1/2" FIP x 1/2" FIP x 18"	1/25
G71116	1/2" FIP x 3/4" MIP x 18"	1/25
G71117	3/4" FIP x 3/4" MIP x 18"	1/25
G71118	3/4" FIP x 1/2" MIP x 18"	1/25
G71119	1/2" FIP x 1/2" MIP x 18"	1/25
G71120	3/4" MIP x 3/4" MIP x 24"	1/25
G71121	3/4" MIP x 1/2" MIP x 24"	1/25
G71122	1/2" MIP x 1/2" MIP x 24"	1/25
G71123	3/4" FIP x 3/4" FIP x 24"	1/25
G71124	3/4" FIP x 1/2" FIP x 24"	1/25
G71125	1/2" FIP x 1/2" FIP x 24"	1/25
G71126	1/2" FIP x 3/4" MIP x 24"	1/25
G71127	3/4" FIP x 3/4" MIP x 24"	1/25
G71128	3/4" FIP x 1/2" MIP x 24"	1/25
G71129	1/2" FIP x 1/2" MIP x 24"	1/25
G71130	3/4" MIP x 3/4" MIP x 30"	1/25
G71131	3/4" MIP x 1/2" MIP x 30"	1/25
G71132	1/2" MIP x 1/2" MIP x 30"	1/25
G71133	3/4" FIP x 3/4" FIP x 30"	1/25
G71134	3/4" FIP x 1/2" FIP x 30"	1/25
G71135	1/2" FIP x 1/2" FIP x 30"	1/25
G71136	1/2" FIP x 3/4" MIP x 30"	1/25
G71137	3/4" FIP x 3/4" MIP x 30"	1/25
G71138	3/4" FIP x 1/2" MIP x 30"	1/25
G71139	1/2" FIP x 1/2" MIP x 30"	1/25
G71140	3/4" MIP x 3/4" MIP x 36"	1/25
G71141	3/4" MIP x 1/2" MIP x 36"	1/25
G71142	1/2" MIP x 1/2" MIP x 36"	1/25

5/8" OD Yellow Coated with Fittings (cont.)



- Durable stainless steel 304
- Corrugation extends all the way to the fitting for increased tubing flexibility
- CSA Design certified domestically and internationally for indoor and outdoor use
- 100% leak tested to ensure safety and quality and a product you can trust
- Quality flared end fittings to create a metal to metal seal in critical applications
- Coated connectors add additional safety in highly corrosive environments or in areas where caustic chemicals are located
- Corrosion resistant

PART NO.	DESCRIPTION	CTN/MSTR
G71143	3/4" FIP x 3/4" FIP x 36"	1/25
G71144	3/4" FIP x 1/2" FIP x 36"	1/25
G71145	1/2" FIP x 1/2" FIP x 36"	1/25
G71146	1/2" FIP x 3/4" MIP x 36"	1/25
G71147	3/4" FIP x 3/4" MIP x 36"	1/25
G71148	3/4" FIP x 1/2" MIP x 36"	1/25
G71149	1/2" FIP x 1/2" MIP x 36"	1/25
G71150	3/4" MIP x 3/4" MIP x 48"	1/25
G71151	3/4" MIP x 1/2" MIP x 48"	1/25
G71152	1/2" MIP x 1/2" MIP x 48"	1/25
G71153	3/4" FIP x 3/4" FIP x 48"	1/25
G71154	3/4" FIP x 1/2" FIP x 48"	1/25
G71155	1/2" FIP x 1/2" FIP x 48"	1/25
G71156	1/2" FIP x 3/4" MIP x 48"	1/25
G71157	3/4" FIP x 3/4" MIP x 48"	1/25
G71158	3/4" FIP x 1/2" MIP x 48"	1/25
G71159	1/2" FIP x 1/2" MIP x 48"	1/25
G71160	3/4" MIP x 3/4" MIP x 60"	1/25
G71161	3/4" MIP x 1/2" MIP x 60"	1/25
G71162	1/2" MIP x 1/2" MIP x 60"	1/25
G71167	3/4" FIP x 3/4" MIP x 60"	1/25
G71168	3/4" FIP x 1/2" MIP x 60"	1/25
G71169	1/2" FIP x 1/2" MIP x 60"	1/25
G71170	3/4" MIP x 3/4" MIP x 72"	1/25
G71172	1/2" MIP x 1/2" MIP x 72"	1/25
G71173	3/4" FIP x 3/4" FIP x 72"	1/25
G71174	3/4" FIP x 1/2" FIP x 72"	1/25
G71176	1/2" FIP x 3/4" MIP x 72"	1/25
G71177	3/4" FIP x 3/4" MIP x 72"	1/25
G71179	1/2" FIP x 1/2" MIP x 72"	1/25

1/2" OD Yellow Coated with Fittings



- Durable stainless steel 304
- Corrugation extends all the way to the fitting for increased tubing flexibility
- CSA Design certified domestically and internationally for indoor and outdoor use
- 100% leak tested to ensure safety and quality and a product you can trust
- Quality flared end fittings to create a metal to metal seal in critical applications
- Coated connectors add additional safety in highly corrosive environments or in areas where caustic chemicals are located
- Corrosion resistant

PART NO.	DESCRIPTION	CTN/MSTR
G72100	1/2" MIP x 1/2" MIP x 12"	1/25
G72101	1/2" MIP x 3/8" MIP x 12"	1/25
G72102	3/8" MIP x 3/8" MIP x 12"	1/25
G72103	1/2" FIP x 1/2" FIP x 12"	1/25
G72104	1/2" FIP x 3/8" FIP x 12"	1/25
G72105	1/2" FIP x 1/2" MIP x 12"	1/25
G72107	3/8" FIP x 1/2" MIP x 12"	1/25
G72108	1/2" MIP x 1/2" MIP x 18"	1/25
G72109	1/2" MIP x 3/8" MIP x 18"	1/25
G72110	3/8" MIP x 3/8" MIP x 18"	1/25
G72111	1/2" FIP x 1/2" FIP x 18"	1/25
G72112	1/2" FIP x 3/8" FIP x 18"	1/25
G72113	1/2" FIP x 1/2" MIP x 18"	1/25
G72114	1/2" FIP x 3/8" MIP x 18"	1/25
G72115	3/8" FIP x 1/2" MIP x 18"	1/25
G72116	1/2" MIP x 1/2" MIP x 24"	1/25
G72117	1/2" MIP x 3/8" MIP x 24"	1/25
G72118	3/8" MIP x 3/8" MIP x 24"	1/25
G72119	1/2" FIP x 1/2" FIP x 24"	1/25
G72120	1/2" FIP x 3/8" FIP x 24"	1/25
G72121	1/2" FIP x 1/2" MIP x 24"	1/25
G72122	1/2" FIP x 3/8" MIP x 24"	1/25
G72123	3/8" FIP x 1/2" MIP x 24"	1/25
G72124	1/2" MIP x 1/2" MIP x 30"	1/25
G72126	3/8" MIP x 3/8" MIP x 30"	1/25
G72127	1/2" FIP x 1/2" FIP x 30"	1/25
G72128	1/2" FIP x 3/8" FIP x 30"	1/25
G72129	1/2" FIP x 1/2" MIP x 30"	1/25
G72130	1/2" FIP x 3/8" MIP x 30"	1/25
G72131	3/8" FIP x 1/2" MIP x 30"	1/25
G72132	1/2" MIP x 1/2" MIP x 36"	1/25
G72133	1/2" MIP x 3/8" MIP x 36"	1/25
G72134	3/8" MIP x 3/8" MIP x 36"	1/25
G72135	1/2" FIP x 1/2" FIP x 36"	1/25
G72136	1/2" FIP x 3/8" FIP x 36"	1/25
G72137	1/2" FIP x 1/2" MIP x 36"	1/25
G72140	1/2" MIP x 1/2" MIP x 48"	1/25
G72141	1/2" MIP x 3/8" MIP x 48"	1/25
G72142	3/8" MIP x 3/8" MIP x 48"	1/25
G72143	1/2" FIP x 1/2" FIP x 48"	1/25
G72144	1/2" FIP x 3/8" FIP x 48"	1/25

1/2" OD Yellow Coated with Fittings (cont.)



- Durable stainless steel 304
- Corrugation extends all the way to the fitting for increased tubing flexibility
- CSA Design certified domestically and internationally for indoor and outdoor use
- 100% leak tested to ensure safety and quality and a product you can trust
- Quality flared end fittings to create a metal to metal seal in critical applications
- Coated connectors add additional safety in highly corrosive environments or in areas where caustic chemicals are located
- Corrosion resistant

PART NO.	DESCRIPTION	CTN/MSTR
G72146	1/2" FIP x 3/8" MIP x 48"	1/25
G72147	3/8" FIP x 1/2" MIP x 48"	1/25
G72148	1/2" MIP x 1/2" MIP x 60"	1/25
G72149	1/2" MIP x 3/8" MIP x 60"	1/25
G72150	3/8" MIP x 3/8" MIP x 60"	1/25
G72151	1/2" FIP x 1/2" FIP x 60"	1/25
G72152	1/2" FIP x 3/8" FIP x 60"	1/25
G72153	1/2" FIP x 1/2" MIP x 60"	1/25
G72154	1/2" FIP x 3/8" MIP x 60"	1/25
G72155	3/8" FIP x 1/2" MIP x 60"	1/25

1/2" OD Yellow Coated with Ball Valve



- Durable stainless steel 304
- Corrugation extends all the way to the fitting for increased tubing flexibility
- CSA Design certified domestically and internationally for indoor and outdoor use
- 100% leak tested to ensure safety and quality and a product you can trust
- Quality flared end fittings to create a metal to metal seal in critical applications
- Coated connectors add additional safety in highly corrosive environments or in areas where caustic chemicals are located
- Corrosion resistant

PART NO.	DESCRIPTION	CTN/MSTR
G72300	1/2" MIP x 1/2" FIP Ball x 12"	1/25
G72302	1/2" FIP x 1/2" FIP Ball x 12"	1/25
G72304	1/2" MIP x 1/2" FIP Ball x 18"	1/25
G72306	1/2" FIP x 1/2" FIP Ball x 18"	1/25
G72308	1/2" MIP x 1/2" FIP Ball x 24"	1/25
G72310	1/2" FIP x 1/2" FIP Ball x 24"	1/25
G72312	1/2" MIP x 1/2" FIP Ball x 30"	1/25
G72314	1/2" FIP x 1/2" FIP Ball x 30"	1/25
G72316	1/2" MIP x 1/2" FIP Ball x 36"	1/25
G72318	1/2" FIP x 1/2" FIP Ball x 36"	1/25
G72320	1/2" MIP x 1/2" FIP Ball x 48"	1/25
G72322	1/2" FIP x 1/2" FIP Ball x 48"	1/25
G72324	1/2" MIP x 1/2" FIP Ball x 60"	1/25
G72326	1/2" FIP x 1/2" FIP Ball x 60"	1/25
G72328	1/2" MIP x 1/2" FIP Ball x 72"	1/25
G72330	1/2" FIP x 1/2" FIP Ball x 72"	1/25
G72332	1/2" MIP x 1/2" FIP Angle Ball x 24"	1/25
G72333	1/2" MIP x 1/2" FIP Angle Ball x 36"	1/25
G72334	1/2" MIP x 1/2" FIP Angle Ball x 48"	1/25
G72335	1/2" MIP x 1/2" FIP Angle Ball x 72"	1/25

1" OD Yellow Coated with Fittings



- Durable stainless steel 304
- Corrugation extends all the way to the fitting for increased tubing flexibility
- CSA Design certified domestically and internationally for indoor and outdoor use
- 100% leak tested to ensure safety and quality and a product you can trust
- Quality flared end fittings to create a metal to metal seal in critical applications
- Coated connectors add additional safety in highly corrosive environments or in areas where caustic chemicals are located
- Corrosion resistant

PART NO.	DESCRIPTION	CTN/MSTR
G71401	3/4" MIP x 3/4" FIP x 18"	1/25
G71402	3/4" MIP x 3/4" FIP x 24"	1/25
G71403	3/4" MIP x 3/4" MIP x 18"	1/25
G71404	3/4" MIP x 3/4" MIP x 24"	1/25

1/2" OD Black Coated



- Durable stainless steel 304
- For use with gas logs
- Corrugation extends all the way to the fitting for increased tubing flexibility
- CSA Design certified domestically and internationally for indoor and outdoor use
- 100% leak tested to ensure safety and quality and a product you can trust
- Quality flared end fittings to create a metal to metal seal in critical applications
- Coated connectors add additional safety in highly corrosive environments or in areas where caustic chemicals are located.
- Corrosion resistant

PART NO.	DESCRIPTION	CTN/MSTR
G74103	1/2" FIP x 1/2" FIP x 12"	1/25
G74105	1/2" FIP x 1/2" MIP x 12"	1/25
G74111	1/2" FIP x 1/2" FIP x 18"	1/25
G74113	1/2" FIP x 1/2" MIP x 18"	1/25
G74119	1/2" FIP x 1/2" FIP x 24"	1/25
G74121	1/2" FIP x 1/2" MIP x 24"	1/25
G74127	1/2" FIP x 1/2" FIP x 30"	1/25
G74129	1/2" FIP x 1/2" MIP x 30"	1/25
G74135	1/2" FIP x 1/2" FIP x 36"	1/25
G74137	1/2" FIP x 1/2" MIP x 36"	1/25

3/8" OD Black Coated



- Durable stainless steel 304
- For use with gas logs
- Corrugation extends all the way to the fitting for increased tubing flexibility
- CSA Design certified domestically and internationally for indoor and outdoor use
- 100% leak tested to ensure safety and quality and a product you can trust
- Quality flared end fittings to create a metal to metal seal in critical applications
- Coated connectors add additional safety in highly corrosive environments or in areas where caustic chemicals are located.
- Corrosion resistant

PART NO.	DESCRIPTION	CTN/MSTR
G73101	1/2" FIP x 1/2" FIP x 12"	1/25
G73108	1/2" FIP x 1/2" FIP x 18"	1/25
G73115	1/2" FIP x 1/2" FIP x 24"	1/25
G73122	1/2" FIP x 1/2" FIP x 30"	1/25
G73129	1/2" FIP x 1/2" FIP x 36"	1/25

Nominal Connector Series (I.D. Inches)	Straight Length Capacity - Ptu Per Hr (W) 0.64 Sp Gr. 1000 Btu Per Cu Ft (37.2 MJ Per Cu Meter) Gas at @ 0.5 inch Water Column (124 Pa) Pressure Drop		
	12"	24"	36"
1/4	48000	40000	33400
3/8	102000	85000	71000
1/2	180000	150000	125000

NOTE: When using 0.2 inch water column pressure drop, capacity can be determined by multiplying the figures above by 0.632.

MISC. PLUMBING SPECIALTIES

Repair 95-96

Test Caps & Plugs 97-98

Flexible Transition Couplings 98-99

Dishwasher/Washing Machine Parts 100

Dryer Vents..... 101-102

Tape..... 103

Pipe Sleeving/Sand Cloth 104

Rubber Insulation 105-108

Poly Insulation..... 109-111

Insulation Tools/Dielectric Union..... 112

Water Heater Connectors..... 113

Water Heater Supplies..... 114

Pressure Gauges 115-116

Tubing 117

Stud Guards 118-120

Hooks & Nails..... 121

Pipe Strap/Clamps..... 122

Hanger Tape/Packing..... 123

Lead Supplies/Roofing Repair 124-125

Service Sink Repair 126

Bolts & Screws 127

Washers/Clamps 127

Conduit Hanger 128

Water Meter Supplies 129

Meter Boxes..... 130

Boxes 131

C

*Published March 2017. List prices can be found in list price book and on our website.

Snap-Ease Access Panel



- Constructed of high-impact white ABS
- Can be painted or wallpapered
- Easily installed to eliminate unsightly drywall repairs
- Provides for future access to plumbing or wiring behind wall
- 5/8" depth

PART NO.	DESCRIPTION	CTN/MSTR
A04006	6" x 9" access panel	10/80
A05008	8" x 8" access panel	1/10
A05014	14" x 14" access panel	10/30
A05027	14" x 27" access panel	1/6

Spring Loaded Plastic Access Panel



- Quick and easy installation
- Can be painted or wallpapered
- No framing needed
- Spring loaded clips make removal simple

New!

PART NO.	DESCRIPTION	CTN/MSTR
A06008	8" x 8" access panel	1/25
A06014	14" x 14" access panel	1/25

Plastic Access Panel



- Beveled edges
- Indented screw holes in corners

PART NO.	DESCRIPTION	CTN/MSTR
A04012	12" x 12" access panel	1/25

Stainless Steel Repair Clamp



Two Bolt

One Bolt

- Plated lug, carriage bolt and nuts for corrosion protection
- 301 stainless steel clamp with neoprene gaskets for up to 180°F
- Long neck carriage bolts for easy installation

PART NO.	DESCRIPTION	IPS/SCH 40	CTS NOM	CTN/MSTR
R30375	3" one bolt	3/8"	1/2"	6/72
R30050	3" one bolt	1/2"	3/4"	6/72
R30075	3" one bolt	3/4"	1"	6/72
R30100	3" one bolt	1"	1-1/4"	6/72
R30125	3" one bolt	1-1/4"	1-1/2"	6/72
R30150	3" one bolt	1-1/2"	-	6/72
R30200	3" one bolt	2"	-	6/72
R30250	3" one bolt	2-1/2"	-	6/48
R30300	3" one bolt	3"	-	6/36
R30400	3" one bolt	4"	-	6/24
R30600	3" one bolt	6"	-	1/36
R60375	6" two bolt	3/8"	1/2"	6/36
R60050	6" two bolt	1/2"	3/4"	6/36
R60075	6" two bolt	3/4"	1"	6/36
R60100	6" two bolt	1"	1-1/4"	6/36
R60125	6" two bolt	1-1/4"	1-1/2"	6/36
R60150	6" two bolt	1-1/2"	-	6/36
R60200	6" two bolt	2"	-	6/36
R60250	6" two bolt	2-1/2"	-	6/24
R60300	6" two bolt	3"	-	6/24
R60400	6" two bolt	4"	-	6/24
R60600	6" two bolt	6"	-	1/20

Items marked with the Jones Stephens logo are "You Need It...We Got It" Items.

Malleable Iron Compression Coupling



- Long pattern
- EPDM gaskets
- Metal friction ring
- Maximum 125 PSI at 120°F
- Pipe ends must be restrained
- Fits both IPS and Schedule 40 pipe
- Galvanized for corrosion protection

PART NO.	IPS	BODY LENGTH	CTN/MSTR
C11050	1/2"	3-3/8"	1/42
C11075	3/4"	3-5/8"	1/32
C11100	1"	3-7/8"	1/24
C11125	1-1/4"	4-1/8"	1/18
C11150	1-1/2"	4-5/16"	1/15
C11200	2"	4-1/2"	1/12
C11250	2-1/2"	6-3/4"	1/4
C11300	3"	7"	1/4
C11400	4"	8-1/8"	1/2

Bronze Compression Coupling



- EPDM gaskets
- Bronze coated brass bodies and nuts
- Maximum 125 PSI at temperatures up to 180°F
- Pipe ends must be restrained on both ends
- For use on galvanized pipe and copper tubing
- Lead Free

PART NO.	DESCRIPTION	CTS	IPS	CTN/MSTR
C14205	3" length	1/2"	3/8"	1/120
C14206	3" length	3/4"	1/2"	12/120
C14207	3" length	1"	3/4"	12/72
C15300	5" length	1/2"	3/8"	1/96
C15301	5" length	3/4"	1/2"	12/72
C15302	5" length	1"	3/4"	12/48
C15303	5" length	1-1/4"	1"	12/48
C15304	5" length	1-1/2"	1-1/4"	12/36
C15305	5" length	-	1-1/2"	12/36
C15306	5" length	2"	-	1/30
C15307	5" length	-	2"	12/24

PVC Compression Coupling



- For use on cold water lines only
- Ribbed body and nuts for gripping
- Fits IPS and Schedule 40 pipe
- EPDM gaskets
- 150 PSI at 73°F
- Pipe ends must be restrained

PART NO.	IPS	BODY LENGTH	CTN/MSTR
C12050	1/2"	3-3/4"	30/120
C12075	3/4"	3-15/16"	30/120
C12100	1"	4-3/4"	25/100
C12125	1-1/4"	5-3/16"	25/100
C12150	1-1/2"	5-3/8"	15/60
C12200	2"	6"	6/24
C12250	2-1/2"	7-7/8"	3/12
C12300	3"	8"	2/8
C12400	4"	12"	2/8
C12600	6"	11-1/8"	1/4

PVC Expansion Coupling



• Rated 200 PSI

PART NO.	IPS	BODY LENGTH	CTN/MSTR
E09050	1/2"	5-3/4"	1/160
E09075	3/4"	6-3/4"	1/120
E09100	1"	7-3/4"	1/54
E09125	1-1/4"	9"	1/40
E09150	1-1/2"	10"	1/35
E09200	2"	10-1/2"	1/24
E09250	2-1/2"	13"	1/3
E09300	3"	14-1/2"	1/3
E09400	4"	14-1/2"	1/3

CPVC Compression Coupling



- For use on hot water lines
- 100 PSI at temperatures up to 180°F
- Tubing sizes copper and plastic tubing
- EPDM gaskets
- Ribbed body and nuts for gripping
- Pipe ends must be restrained

PART NO.	TUBING SIZE	CTN/MSTR
C13050	1/2" (5/8" OD)	20/360
C13075	3/4" (7/8" OD)	20/240

Bronze Compression Tee



- FIP branch
- EPDM gaskets
- Pipe ends must be restrained
- Bronze coated brass bodies and nuts
- Maximum 125 PSI at temperatures up to 180°F
- For use on galvanized pipe and copper tubing (check sizes)

PART NO.	CTS	IPS	BRANCH	CTN/MSTR
C19050	1/2"	3/8"	1/2" FIP	1/112
C19051	3/4"	1/2"	1/2" FIP	1/96
C19075	3/4"	1/2"	3/4" FIP	1/96

PVC Compression Tee



- For use on cold water lines only
- Ribbed body and nuts for gripping
- Fits both IPS and Schedule 40 pipe
- EPDM gaskets
- 150 PSI at 73°F
- Threaded branch

PART NO.	SIZE	CTN/MSTR
C17050	1/2"	25/100
C17075	3/4"	1/90
C17100	1"	15/60
C17125	1-1/4"	1/40
C17150	1-1/2"	1/30
C17200	2"	1/20

Economy Test Plug



- Galvanized steel flanges
- Fits cast iron and plastic pipe
- Neoprene rubber gasket

PART NO.	PIPE SIZE	CTN/MSTR
T31001	1-1/2"	24/192
T31002	2"	24/96
T31003	3"	24/48
T31004	4"	24/48
T31006	6"	4/16
T31000	Replacement wing nut	1/5000

Combination Test Plug



Raised Head



Countersunk

- Test up to three floors at once
- Combination test plug and cleanout
- Fits Schedule 40 DWV pipe
- Positive sealing
- No metal parts to rust

PART NO.	DESCRIPTION	CTN/MSTR
T34001	1-1/2" raised head	1/392
T34002	2" raised head	1/288
T34003	3" raised head	1/200
T34004	4" raised head	1/128
T34006	6" raised head	1/54
T34008	8" raised head	1/24
T34012	2" countersunk	1/288
T34013	3" countersunk	1/200
T34014	4" countersunk	1/128

T-Cone Cleanout Repair Plugs



- Easily repairs damaged or corroded metal or plastic cleanout threads

PART NO.	PIPE SIZE	THREAD ID	CTN/MSTR
T34150	1-1/2"	1.780	1/50
T34200	2"	2.255	1/50
T34300	3"	3.375	1/50
T34350	3-1/2"	3.900	1/50
T34400	4"	4.336	1/50

"Plum-Tite" Mechanical Test Plugs



- High density plastic construction
- Neoprene gasket
- Extra large wingnut
- Rust and corrosion proof

PART NO.	PIPE SIZE	CTN/MSTR
T37001	1-1/2"	10/200
T37002	2"	10/150
T37003	3"	10/40
T37004	4"	10/40
T37006	6"	5/20
T37008	8"	5/10

Items marked with the Jones Stephens logo are "You Need It... We Got It" Items.

Cast Iron Test Plug



- Maximum 10 PSI
- To test cast iron soil pipe drainage systems
- Cold water ONLY

PART NO.	PIPE SIZE	CTN/MSTR
T39002	2"	1/40
T39003	3"	1/20
T39004	4"	1/12
T39006	6"	1/6
T39008	8"	1/2
T39010	10"	1/2
T39012	12"	1/1

Flexible PVC Test Cap



- Reinforced top
- 5/16" hex screw with screwdriver slot
- Fits both cast iron and plastic pipe

PART NO.	PIPE SIZE	CTN/MSTR
T32001	1-1/2" standard	20/160
T32002	2" standard	24/288
T32003	3" standard	24/144
T32004	4" standard	1/50
T32006	6" standard	1/24
T32008	8" standard	1/16
T32011	1-1/2" heavy duty	1/200
T32022	2" heavy duty	1/100
T32033	3" heavy duty	1/50
T32044	4" heavy duty	1/50

PVC Dual Fit Test Cap



- Each cap fits two sizes of Schedule 40 pipe
- CARTON QUANTITIES ONLY

PART NO.	PIPE SIZE	CTN/MSTR
T33152	1-1/2" and 2"	100/100
T33304	3" and 4"	25/25

Slip-On Plastic Cap



- DWV protection cap
- Protects from debris during construction
- Orange

PART NO.	SIZE	CTN/MSTR
T36150	1-1/2"	1/300
T36200	2"	1/200
T36300	3"	1/75
T36400	4"	1/45
T36600	6"	1/25

Techno Test Plug Cap



- Heavy duty PVC, high pressure tested over six stories
- Easily solvent cemented over end of DWV pipe
- Will not clog or go down pipe
- CARTON QUANTITIES ONLY

PART NO.	DESCRIPTION	CTN/MSTR
T35001	1-1/2" DWV	100/100
T35002	2" DWV	100/100
T35003	3" DWV	50/50
T35004	4" DWV	25/25

PVC Test Cap



- Easily solvent cemented over end of DWV pipe
- CARTON QUANTITIES ONLY

PART NO.	DESCRIPTION	CTN/MSTR
T35201	1-1/2" PVC test cap	100/1000
T35202	2" PVC test cap	100/1000
T35203	3" PVC test cap	50/250
T35204	4" PVC test cap	25/250
T35206	6" PVC test cap	1/100

Knockout Test Cap



- For use in plastic waste and drain pipe
- Disposable
- CARTON QUANTITIES ONLY

PART NO.	PIPE SIZE	CTN/MSTR
T33001	1-1/2"	100/5000
T33002	2"	100/5000
T33003	3"	50/2400
T33004	4"	50/1200

Pneumatic Test Plug



Regular Long

- All units smaller than 8" are supplied with chain and ring
- All units 8" or larger are supplied with a removable eye bolt
- For use with cast iron, PVC, ABS, copper, clay and concrete pipe
- Made in the USA

MADE IN THE USA

Regular					
PART NO.	NOM. PIPE SIZE	MAX AIR PRESSURE	MAX TEST PRESSURE	MAX HEAD	CTN/MSTR
T45150	1-1/4" - 1-1/2"	40 PSI	5 PSI	30'	1/6
T45200	2"	40 PSI	5 PSI	30'	1/6
T45300	3"	35 PSI	5 PSI	30'	1/6
T45400	4"	30 PSI	5 PSI	30'	1/6
T45600	6"	25 PSI	5 PSI	30'	1/1
T45800	8"	25 PSI	15 PSI	40'	1/1
T45010	10"	25 PSI	15 PSI	40'	1/1
T45012	12"	25 PSI	15 PSI	40'	1/1
Long - 23"					
PART NO.	NOM. PIPE SIZE	MAX AIR PRESSURE	MAX TEST PRESSURE	MAX HEAD	CTN/MSTR
T46200	2"	45 PSI	5 PSI	30'	1/1
T46300	3"	35 PSI	5 PSI	30'	1/1
T46400	4"	30 PSI	5 PSI	30'	1/1

Items marked with the Jones Stephens logo are "You Need It... We Got It" Items.

Pneumatic-Hydraulic Test Plug



- Uses either water or air
- Temperature range 30° - 200°F
- User safe; cannot be overinflated
- Individually tested for 24 hours to insure proper operation
- Using water, stack can be filled and plugged from same position
- Made in the USA

MADE IN THE
USA

PART NO.	PIPE SIZE	MFG PART NO.	CTN/MSTR
T30002	1-1/4" - 2"	WATP 2	1/6
T30034	3 - 4"	WATP 3-4	1/10
T30046	4 - 6"	WATP 4-6	1/1
T30068	5" - 8"	WATP 6-8	1/1
T30102	10" - 12"	WATP 10-12	1/1

Two Stage Long Test Plug



- Two stage deflation allows access pipe to remain sealed while water clears drain line

PART NO.	PIPE SIZE	MFG PART NO.	CTN/MSTR
T30203	2" - 3"	DDO203	1/1
T30304	3" - 4"	DDO304	1/1

Inflatable Tee Plug



- Body is high quality natural rubber
- Top is made from high impact ABS plastic
- Threads directly into test tee
- Threads into both cast iron and plastic pipe

PART NO.	DESCRIPTION	CTN/MSTR
T33200	2" Inflatable tee plug	6/36
T33300	3" Inflatable tee plug	1/6
T33400	4" Inflatable tee plug	1/6

Drain King®



D18501



D18186



D18034



D18750



D18340

- Insert in drain line opening and turn water on
- Automatically seals drain and powerful water pulses loosen and clear drain
- Brass on each end

PART NO.	PIPE SIZE	DK NO.	CTN/MSTR
D18501	1" - 2"	D501	1/12
D18186	1-1/2" - 3"	D186	12/144
D18034	3" - 4"	H34	1/6
D18750	3" - 6"	D750	1/6
D18850	6" - 10"	D850	1/1
D18340	1-1/2" - 3" with 10" hose and faucet adapter	PE60	1/12
D18060	Drain adapter	PE60	1/12

Plumbjet



D18400



D18401

- Attaches to garden hose
- All natural
- Environmentally safe

PART NO.	PIPE SIZE	DK NO.	CTN/MSTR
D18400	1" - 2"	D501	10/60
D18401	1-1/2" - 3"	D186	10/60

Extension Hose



- For pneumatic test plug
- Can be used in tandem

PART NO.	DESCRIPTION	CTN/MSTR
T45002	2' extension hose	1/6
T45003	3' extension hose	1/6

Force Cup Plunger



Red Rubber



Black Rubber

- Highest quality rubber
- Supplied with handle

PART NO.	DESCRIPTION	CTN/MSTR
D18001	5 1/2" diameter (red rubber)	1/48
D18002	6" professional style (black rubber)	1/24

Professional Force Cup Display



Display

- Highest quality rubber
- Supplied with handle
- Attractive point of purchase display
- Display box contains 30 rubber plungers
- CARTON QUANTITIES ONLY

PART NO.	DESCRIPTION	CTN/MSTR
D18000	Rubber plungers and display box	30/30

Toilet Plunger



D18020



D18021



D18022

- Professional quality
- Yellow hardwood handles with black tailpiece

PART NO.	DESCRIPTION	CTN/MSTR
D18020	Thronemaster® professional stepped plunger	1/4
D18021	Professional plumber's plunger	1/12
D18022	HYDRO-TRUST heavy duty deluxe plunger	1/24

Qwik Tee



PART NO.	DESCRIPTION	CTN/MSTR
T07150	1-1/2" x 1-1/2" x 1-1/2" tee	1/50
T07200	2" x 2" x 2" tee	1/20
T07300	3" x 3" x 3" tee	1/20
T07400	4" x 4" x 4" tee	1/6

Qwik Elbow



- Flexible

PART NO.	DESCRIPTION	CTN/MSTR
E10150	1-1/2" x 1-1/2" elbow	1/50
E10200	2" x 2" elbow	1/20
E10300	3" x 3" elbow	1/20
E10400	4" x 4" elbow	1/6

Flexible PVC Saddle Fitting



Tee Pattern



Wye Pattern

- Provided with stainless steel clamp on inlet
- Includes stainless steel clamps on saddle to fit up to 12" clay pipe
- Extension clamps may be used for larger pipe sizes

Tee Pattern

PART NO.	DESCRIPTION	CTN/MSTR
S26001	6" plastic - 12" clay saddle x 4" Sch.40 CI or SDR35 inlet	1/1
S26002	6" plastic - 12" clay saddle x 6" Sch.40 CI or SDR35 inlet	1/1

Wye Pattern

PART NO.	DESCRIPTION	CTN/MSTR
S27001	6" plastic - 12" clay saddle x 4" Sch. 40 cast iron or SDR35 inlet	1/1
S27002	6" plastic - 12" clay saddle x 6" Sch. 40 cast iron or SDR35 inlet	1/1

Replacement Clamp

PART NO.	DESCRIPTION	CTN/MSTR
S26100	4"-12" gear clamp	1/100

Flexible Trap Drain Connector



PART NO.	DESCRIPTION	CTN/MSTR
T06001	Connects 1-1/4" - 1 1/2" tubular to 1-1/4" - 1-1/2" tubular	1/180
T06002	Connects 1-1/4" DWV or 1-1/2" CTS to 1-1/4" - 1-1/2" tubular	1/100
T06003	Connects 1-1/2" DWV or CTS to 1-1/4" - 1-1/2" tubular	1/100
T06004	Connects 2" DWV to 1-1/4" - 1-1/2" tubular	1/100

Flexible Transition Coupling



T06320



T06400



- Flexible PVC
- For use on PVC, DWV and CI pipe
- Stainless steel clamps and housing
- UPC listed

PART NO.	DESCRIPTION	CTN/MSTR
T06025	1-1/4" PL + CI to PL + CI	1/300
T06050	1-1/2" PL + CI to PL + CI	1/150
T06024	1-1/2" x 1-1/4" PL + CI to PL + CI	1/100
T06200	2" PL + CI to PL + CI	1/105
T06250	2" x 1-1/2" PL + CI to PL + CI	1/105
T06300	3" PL + CI to PL + CI	1/60
T06320	3" x 2" PL + CI to PL + CI	1/80
T06400	4" PL + CI to PL + CI	1/36
T06430	4" x 3" PL + CI to PL + CI	1/44
T06600	6" PL + CI to PL + CI	1/12
T06640	6" x 4" PL + CI to PL + CI	1/15
T06800	8" PL + CI to PL + CI	1/6

Items marked with the Jones Stephens logo are "You Need It...We Got It" Items.

Bore O-Ring



PART NO.	DESCRIPTION	CTN/MSTR
B12640	6" bore x 4" plastic or cast iron	1/60

Bushing for Qwik Tees and Qwik Elbows



PART NO.	DESCRIPTION	CTN/MSTR
B12210	2" x 1-1/2" bushing	1/24
B12320	3" x 2" bushing	1/24
B12430	4" x 3" bushing	1/24

Hose Grip Clothes Washer Connector



- Fits 1-1/2" or 2" standpipe
- Fits 1" - 1-7/16" drain hose
- Securely holds drain hose in standpipe

PART NO.	DESCRIPTION	CTN/MSTR
D08001	Drain hose connector	1/100

Flexible Drain Trap



- J-bend

PART NO.	DESCRIPTION	CTN/MSTR
J01001	1-1/4" or 1-1/2" tubular trap j-bend	1/20

Center Outlet Washing Machine Boxes



- NEW Compact design!
- All valves are quarter turn
- Easy to remove test plug
- Can be adapted to side outlet if needed
- IAPMO listed

New!



Without Water Hammer Arrestor

PART NO.	DESCRIPTION	CTN/MSTR
B05940	1/2" MIP/SWEAT	1/6
B05941	1/2" CPVC	1/6
B05942	1/2" PEX	1/6
B05943	3/8" PEX	1/6
B05944	1/2" Wirsbo Style PEX	1/6

With Water Hammer Arrestor

PART NO.	DESCRIPTION	CTN/MSTR
B05946	1/2" MIP/SWEAT	1/6
B05947	1/2" CPVC	1/6
B05948	1/2" PEX	1/6
B05949	3/8" PEX	1/6
B05950	1/2" Wirsbo Style PEX	1/6

Replacement Frame

PART NO.	DESCRIPTION	CTN/MSTR
B05927	Replacement frame for washing machine box	1/1

Right Outlet Washing Machine Boxes



- NEW Compact design!
- All valves are quarter turn
- Easy to remove test plug
- IAPMO listed

New!



Without Water Hammer Arrestor

PART NO.	DESCRIPTION	CTN/MSTR
B05740	1/2" MIP/SWEAT	1/6
B05741	1/2" CPVC	1/6
B05742	1/2" PEX	1/6
B05743	3/8" PEX	1/6
B05744	1/2" Wirsbo Style PEX	1/6
B05751	Single Lever, 1/2" MIP/SWT	1/6
B05752	Single Lever, 1/2" CPVC	1/6
B05753	Single Lever, 1/2" PEX	1/6
B05754	Single Lever, 3/8" PEX	1/6
B05755	Single Lever, 1/2" Wirsbo Style PEX	1/6

With Water Hammer Arrestor

PART NO.	DESCRIPTION	CTN/MSTR
B05746	1/2" MIP/SWEAT	1/6
B05747	1/2" CPVC	1/6
B05748	1/2" PEX	1/6
B05749	3/8" PEX	1/6
B05750	1/2" Wirsbo Style PEX	1/6
B05756	Single Lever, 1/2" MIP/SWT	1/6
B05757	Single Lever, 1/2" CPVC	1/6
B05758	Single Lever, 1/2" PEX	1/6
B05759	Single Lever, 3/8" PEX	1/6
B05760	Single Lever, 1/2" Wirsbo Style PEX	1/6

Replacement Frame

PART NO.	DESCRIPTION	CTN/MSTR
B05927	Replacement frame for washing machine box	1/1

Left Outlet Washing Machine Boxes



- NEW Compact design!
- All valves are quarter turn
- Easy to remove test plug
- IAPMO listed

New!



Without Water Hammer Arrestor

PART NO.	DESCRIPTION	CTN/MSTR
B05840	1/2" MIP/SWEAT	1/6
B05841	1/2" CPVC	1/6
B05842	1/2" PEX	1/6
B05843	3/8" PEX	1/6
B05844	1/2" Wirsbo Style PEX	1/6
B05851	Single Lever, 1/2" MIP/SWT	1/6
B05852	Single Lever, 1/2" CPVC	1/6
B05853	Single Lever, 1/2" PEX	1/6
B05854	Single Lever, 3/8" PEX	1/6
B05855	Single Lever, 1/2" Wirsbo Style PEX	1/6

With Water Hammer Arrestor

PART NO.	DESCRIPTION	CTN/MSTR
B05845	1/2" MIP/SWEAT	1/6
B05847	1/2" CPVC	1/6
B05848	1/2" PEX	1/6
B05849	3/8" PEX	1/6
B05850	1/2" Wirsbo Style PEX	1/6
B05856	Single Lever, 1/2" MIP/SWT	1/6
B05857	Single Lever, 1/2" CPVC	1/6
B05858	Single Lever, 1/2" PEX	1/6
B05859	Single Lever, 3/8" PEX	1/6
B05860	Single Lever, 1/2" Wirsbo Style PEX	1/6

Replacement Frame

PART NO.	DESCRIPTION	CTN/MSTR
B05927	Replacement frame for washing machine box	1/1

Icemaker Boxes with Valves



- New design!
- Includes two fixed nails for installation
- Blue handle valves
- UPC listed
- IAPMO listed

New!



PART NO.	DESCRIPTION	CTN/MSTR
B05910LF	with MIP/SWT connection	1/10
B05911LF	with Flowguard all CPVC icemaker connection	1/10
B05913LF	with 1/2" PEX connection	1/12
B05914LF	with 1/2" Wirsbo® style connection	1/12
B05925LF	with MIP/SWT connection and WHA	1/10
B05926LF	with CPVC connection and WHA	1/10
B05931LF	with 1/2" PEX connection and WHA	1/12
B05932LF	with 1/2" Wirsbo® style connection and WHA	1/12

Replacement Frame

PART NO.	DESCRIPTION	CTN/MSTR
B05928	Replacement frame for icemaker box	1/1

Dishwasher Hose



- EPDM material with single spiral reinforcement
- 5/8" connects dishwasher pump to airgap inlet or dishwasher tailpiece
- 7/8" connects airgap outlet to branch tailpiece or disposal
- Resists kinking
- Marked per foot
- -40°F to +180°F
- IAPMO/UPC listed; meets ANSI, AHAM-DWI specifications



PART NO.	SIZE	WP	BURST PRESSURE	CTN/MSTR
D10625	5/8" ID x 50'	90	200	1/1
D10875	7/8" ID x 50'	70	100	1/1

Dishwasher Drain Connector



- 410 Stainless steel clamps
- Includes two worm gear clamps

PART NO.	DESCRIPTION	CTN/MSTR
D10001	Universal connector	50/200

Washing Machine Hose



Straight Female



With 90° Elbow

- 3/8" ID rubber for hot or cold use
- Standard female hose threads
- Bursting pressure 800 lbs. per sq. inch
- Bagged with washers

PART NO.	DESCRIPTION	CTN/MSTR
J04104	4' with 90° elbow	1/12
J04105	5' with 90° elbow	1/12
J04106	6' with 90° elbow	1/12
J04004	4' straight female	1/12
J04005	5' straight female	1/12
J04006	6' straight female	1/12

Washing Machine Hose



- Industrial quality
- 1/2" ID EPDM rubber for hot and cold use
- Polyester yarn reinforcement
- 3/4" female hose ends
- Temp. rating -40°F to +190°F
- Stamped brass ends and crimps
- 200 PSI working pressure
- Bagged with washers

PART NO.	DESCRIPTION	CTN/MSTR
J04204	4' washing machine hose	1/12
J04205	5' washing machine hose	1/12
J04206	6' washing machine hose	1/12

Mixer Hose



- High pressure hose; 12" arms
- Individually bagged

PART NO.	DESCRIPTION	CTN/MSTR
J04012	Mixer hose	1/25

Fit-All Drain Hose for Washing Machine



- 3 size step down 3/4", 7/8" and 1" for drain lines
- Individually bagged

PART NO.	DESCRIPTION	CTN/MSTR
J04016	5' fit-all drain hose	1/12

Washing Machine Drain Hose



- Rubber

PART NO.	DESCRIPTION	CTN/MSTR
D10900	1" x 50' roll	1/1

Washing Machine Pan



- 2-1/2" deep heavy gauge plastic pan
- White
- 1" adapter
- CARTON QUANTITIES ONLY

PART NO.	DESCRIPTION	CTN/MSTR
J04250	27" x 29" with side mount drain	1/5

Dryer Vent Hood



- PVC hood
- Weather proof 12" aluminum extension
- Pre-punched mounting holes
- CARTON QUANTITIES ONLY

PART NO.	DESCRIPTION	CTN/MSTR
D04012	4" dryer vent hood	1/12

Aluminum Vent Hood



- For clothes dryers or exhaust fans
- Complete with damper and flange plate

PART NO.	DESCRIPTION	CTN/MSTR
D04023	3" aluminum vent hood	1/12
D04024	4" aluminum vent hood	1/12

Louvered Dryer Vent Hood



- Includes hood, aluminum pipe and collar

PART NO.	DESCRIPTION	CTN/MSTR
D04025	4" white hood assembly	1/12
D04026	4" brown hood assembly	1/12

Items marked with the Jones Stephens logo are "You Need It...We Got It" Items.

Complete Dryer Vent Kit



- Kit includes hose, vent and 2 plastic clamps
- PVC hood
- Weather proof 12" aluminum extension
- Pre-punched mounting holes
- 12" aluminum extension, pre-punched mounting holes

PART NO.	DESCRIPTION	CTN/MSTR
D04005	4" x 5' vent kit	1/10
D04008	4" x 8' vent kit	1/10
D04009	4" x 8' flex aluminum duct with louvered hood and two metal clamps	1/6
D04010	4" clamp only	1/10

Metal Clamp for Dryer Vent



- Heavy duty all metal design
- Excellent for use with metal ducting

PART NO.	DESCRIPTION	CTN/MSTR
D04015	3" metal clamp	1/12
D04016	4" metal clamp	1/12
D04017	5" metal clamp	1/12
D04018	6" metal clamp	1/12

Aluminum Elbow and Pipe



- All aluminum

PART NO.	DESCRIPTION	CTN/MSTR
D04013	3" x 90° swivel elbow	1/12
D04014	3" x 24" aluminum pipe	1/25
D04027	4" x 90° swivel elbow	1/12
D04028	4" x 24" aluminum pipe	1/25

Flexible Duct Connector Kit



- Connects flexible ducting
- Extends exhaust collar of clothes dryer

PART NO.	DESCRIPTION	CTN/MSTR
D04019	4" duct connector kit	1/6

Increaser/Reducer



- Connects 3" to 4" ducting or 4" ducting to 3" exhaust collar

PART NO.	DESCRIPTION	CTN/MSTR
D04021	3"-4" plastic increaser/reducer	1/6
D04022	4"-3" aluminum reducer	1/6
D04055	3"-4" aluminum increaser	1/6

Indoor Dryer Vent Kit



- Use on electric clothes dryers when outside venting is not possible
- Recirculates warm, moist air
- Specially designed lint reservoir

PART NO.	DESCRIPTION	CTN/MSTR
D04036	Indoor dryer vent kit	1/6

Flexible Aluminum Ducting



- Ideal for exhausting clothes dryers
- Bendable to any configuration
- No fire or UL ratings

PART NO.	DESCRIPTION	CTN/MSTR
D04031	3" x 8' aluminum ducting	1/14
D04032	4" x 8' aluminum ducting	1/9
D04033	5" x 8' aluminum ducting	1/6
D04034	6" x 8' aluminum ducting	1/3
D04053	3" x 25' aluminum ducting	1/10
D04054	4" x 25' aluminum ducting	1/6

Proflex Aluminum Foil Ducting



- Flexible, fire resistant
- Will not support combustion
- Wire reinforced

PART NO.	DESCRIPTION	CTN/MSTR
D04058	4" x 5' Proflex aluminum foil ducting	1/12
D04059	4" x 8' Proflex aluminum foil ducting	1/12
D04060	4" x 50' Proflex aluminum foil ducting	1/1

Flexible Aluminum Foil Ducting



- Ideal for exhausting clothes dryers and bathroom fans
- Will not support combustion
- No fire or UL ratings

PART NO.	DESCRIPTION	CTN/MSTR
D04056	4" x 25' aluminum foil ducting	1/1
D04057	4" x 8' aluminum foil ducting	1/12

Dryer Vent Hose



- Wire-reinforced vinyl

PART NO.	DESCRIPTION	CTN/MSTR
D04020	4" x 20' (boxed)	1/5
D04051	4" x 5' (bagged)	1/12

Dryer Vent Kit with Louvered Hood



- Includes vinyl hose, aluminum pipe, collar, clamps and louvered hood

PART NO.	DESCRIPTION	CTN/MSTR
D04001	4" x 5' with white hood	1/10
D04002	4" x 5' with brown hood	1/10
D04003	4" x 8' with white hood	1/10
D04004	4" x 8' with brown hood	1/10

Bathroom Fan Vent Kit



- Contains the following parts for 3" and 4" wall type exhaust fans: 4" x 5' flexible vinyl ducting, clamps, 4" louvered vent, 3"-4" foam increaser

PART NO.	DESCRIPTION	CTN/MSTR
D04035	Bathroom fan vent kit	1/10
D04050	4" x 50' vinyl hose only (boxed)	1/1
D04062	3" x 50' vinyl hose only (boxed)	1/1

Items marked with the Jones Stephens logo are "You Need It... We Got It" Items.

Domestic Pipe Wrap Tape



- Both sides have adhesive
- CARTON QUANTITIES ONLY

PART NO.	COLOR	SIZE	THICKNESS	CTN/MSTR
T16002	Yellow	2" x 100'	12 mil.	24/24
T16004	Yellow	4" x 100'	12 mil.	12/12
T17002	Black	2" x 100'	12 mil.	24/24
T17004	Black	4" x 100'	12 mil.	12/12

Imported Pipe Wrap Tape



- Black tape with PVC backing
- UPC listed
- CARTON QUANTITIES ONLY



PART NO.	SIZE	THICKNESS	CTN/MSTR
T17101	1" x 100'	10 mil.	48/48
T17102	2" x 100'	10 mil.	24/24
T17104	4" x 100'	10 mil.	12/12
T18201	1" x 100'	20 mil.	48/48
T18202	2" x 100'	20 mil.	24/24

Primer for Pipe Wrap Tape



- Maximizes tape performance
- Final step in preparing steel surfaces for taping
- Can more than double adhesion of corrosion tapes to cleaned steel
- CARTON QUANTITIES ONLY
- MOTOR FREIGHT ONLY / FLAMMABLE

PART NO.	DESCRIPTION	CTN/MSTR
T16100	Quart	12/12

Electrical Tape



- Blacky vinyl
- Individually wrapped
- UL listed
- CARTON QUANTITIES ONLY



PART NO.	DESCRIPTION	CTN/MSTR
T20030	3/4" x 60' electrical tape	10/250

Slic-tite® High Density Thread Sealant



- Thickness 4 mil.
- Provides a highly resistant seal on pipe threads for all types of service
- Non-toxic
- Permits easy disassembly, even after years of service
- Sealing temperature: -450°F to 550°F (-268°C to 288°C)
- Pressures: to 2,000 PSI (136 BAR)
- Meets Mil. Spec T-27730A



PART NO.	DESCRIPTION	CTN/MSTR
T19118	1/2" x 600" thread sealant	12/36
T19119	3/4" x 600" thread sealant	12/72

PTFE Thread Seal Tape



- Thickness 3 mil. plus
- Temperature range is 500°F to +650°F
- Withstands pressure up to 5000 PSI
- Meets U.S. government military specification MIL-T27730A

PART NO.	DESCRIPTION	CTN/MSTR
T19122	1/2" x 260" thread seal tape	100/500
T19125	1/2" x 520" thread seal tape	50/350
T19342	3/4" x 260" thread seal tape	50/350
T19345	3/4" x 520" thread seal tape	50/350

Thread Seal Tape Jar Display



- Withstands pressure up to 5000 PSI
- Temperatures to +650°F
- Thickness 3 mil. plus
- Meets U.S. MILSPEC T27730A

PART NO.	DESCRIPTION	CTN/MSTR
CJ1002	1/2" x 260" Teflon tape	1/1

PTFE Yellow Gas Line Thread Seal Tape



- 0035 mil.
- Temperature range is -450°F to +500°F
- Withstands pressure up to 5000 PSI
- Meets U.S. government military specification MIL-T27730A
- UL listed



PART NO.	DESCRIPTION	CTN/MSTR
T19222	1/2" x 260"	100/500

Duct Tape



- Premium grade, waterproof non-elastic reinforced cloth
- Pressure sensitive; vapor and flame resistant
- CARTON QUANTITIES ONLY

PART NO.	DESCRIPTION	THICKNESS	CTN/MSTR
T20020	2" x 60 yds (gray)	8.5 mil.	24/24
T20023	2" x 60 yds (black)	10 mil.	24/24

Box Sealing Tape



PART NO.	DESCRIPTION	CTN/MSTR
T20040	2" x 55 yds	1/36
T20041	2" x 110 yds	1/36
T20050	Dispenser only	1/24

Stretch Wrap



- Use instead of tape to bind packages or parts
- Protects products from dirt and moisture
- Can be used on palletted shipments or small orders
- Great for wrapping lengths of pipe
- CARTON QUANTITIES ONLY

PART NO.	DESCRIPTION	GAUGE	CTN/MSTR
S51120	3" x 700'	120	18/18
S51080	3" x 1000'	80	18/18

C

Stretch Wrap Film and Dispenser



- Secures packages to pallets
- Reduces lost packages
- Retards moisture
- Lowers handling costs
- Wrapping is priced per carton - no broken cartons

PART NO.	DESCRIPTION	CTN/MSTR
S51001	80 gauge wrap 18" x 1500' (4 rolls)	1/1
S51002	Hand dispenser only	1/1

Pipe Sleeving



- Underground sleeving protects against lime reaction in concrete
- Allows expansion and contraction of pipe, minimizing stress
- Individually boxed; color-coded (red for hot, blue for cold)
- IAPMO listed



PART NO.	PIPE SIZE	THICKNESS	COLOR	LENGTH	CTN/MSTR
S22001	1/2"-1"	6 mil	Red	200'	1/20
S22002	1/2"-1"	6 mil	Blue	200'	1/20
S22003	1/2"-1"	10 mil	Red	100'	1/20
S22004	1/2"-1"	10 mil	Blue	100'	1/20
S22005	1/2"-1"	25 mil	Red	100'	1/20
S22006	1/2"-1"	25 mil	Blue	100'	1/20

Water Resistant Sand Cloth



- Dispenser box
- Water resistant aluminum oxide
- 120 grit abrasive cloth for cleaning pipe and fittings

PART NO.	DESCRIPTION	CTN/MSTR
C25000	1-1/2" x 2 yds	1/50
C25001	1-1/2" x 5 yds	1/50
C25002	1-1/2" x 10 yds	1/50
C25003	1-1/2" x 25 yds	1/25

Open Mesh



- Dispenser box
- 100% waterproof
- Polyester on both sides
- 180 grit with large holes for aggressive sanding
- Can be exposed to water and solvents indefinitely without breakdown

PART NO.	DESCRIPTION	CTN/MSTR
C25010	1-1/2" x 5 yds	1/50
C25011	1-1/2" x 10 yds	1/50

Flexible Open Mesh



- Dispenser box
- 100% waterproof
- Polyester on both sides
- 180 grit
- Smaller holes for finer sanding

PART NO.	DESCRIPTION	CTN/MSTR
C25012	1-1/2" x 5 yds	1/50
C25013	1-1/2" x 10 yds	1/50

Waterproof Aluminum Oxide



- Dispenser box
- 100% waterproof
- Wet cut
- 120 grit

PART NO.	DESCRIPTION	CTN/MSTR
C25020	1-1/2" x 5 yds	1/50
C25021	1-1/2" x 10 yds	1/50
C25022	1-1/2" x 25 yds	1/25

SEAMLESS RUBBER

Pipe Insulation

Flexible Closed Cell Insulation



DESCRIPTION

Seamless Rubber Pipe Insulation is an environmentally friendly, CFC-free, flexible elastomeric thermal insulation.

APPLICATIONS

Seamless Rubber Pipe Insulation is used to retard heat gain and prevent condensation or frost formation on refrigerant lines, cold water plumbing, and chilled water systems. It also retards heat flow for hot water plumbing, liquid heating, dual temperature piping, and many solar systems.

Seamless Rubber is recommended for applications ranging from -70°F to 220° F (-57° C to 104° C). The expanded closed cell structure makes Seamless Rubber an efficient insulator and an effective moisture vapor retarder.

Due to its unique microwave curing process, Seamless Rubber has a very tough skin which withstands tearing, rough handling, and severe environmental conditions, and yet is quite flexible for easy installation.

Seamless Rubber has superior cold weather flexibility.

INSTALLATION

With a factory-applied coating of talc on the smooth inner surface, Seamless Rubber slides easily over pipe or tubing for quick installation. When applied to existing lines, tubing is slit lengthwise and snapped into place. (Slitting can be done on the job with a sharp knife. All seams and butt joints should be sealed with Seamless Rubber Contact Adhesive, making sure both surfaces to be joined are coated with adhesive.

OUTDOOR APPLICATIONS

Outdoor applications require UV Protective Coating. For best appearance, two coats are recommended.

UNDERGROUND

For buried lines above the water table, use a clean fill such as sand (3"-5" layer) to protect Seamless Rubber before backfilling. It is recommended that materials to be buried are properly sealed at all seams and butt joints with Contact Adhesive. For optimum performance, the lines should be encased in a conduit to protect them from problems associated with ground water.

RESISTANCE TO MOISTURE VAPOR FLOW

The closed-cell structure of Seamless Rubber effectively retards the flow of moisture vapor, and is considered a low transmittance vapor retarder. For most applications, Seamless Rubber needs no additional protection. Additional vapor barrier protection may be necessary for Seamless Rubber when

installed on low temperature surfaces or where it is exposed to continuous high humidity.

FLAME AND SMOKE RATING

Seamless Rubber Pipe Insulation in wall thicknesses of 1" (25 mm) and below has a flame spread rating of 25 or less and a smoke development rating of 50 or less as tested by ASTM E 84 Method of Testing entitled: "Surface Burning Characteristics of Building Materials."

Numerical flammability ratings alone may not define the performance of products under actual fire conditions. They are provided only for us in the selection of products to meet limits specified, when compared to a known standard.

SPECIFICATION COMPLIANCE

ASTM C 534 Type 1 (Tubing)
ASTM D 1056-91-2C1
MEA 186-86-M Vol. IV (New York City)
USDA Requirements

UL 94-5V Flammability Classification (Recognition No. E55475)
Complies with requirements of CAN/ULC S102-M88
ASTM E 84 1" 25/50-tested according to UL 723 and NFPA 255

Meets requirements of NFPA 90A Sect. 2.3.3 for Supplementary Materials for Air Distribution Systems

NFPA No. 101 Class A Rating
Meets requirements of UL 181 sections 11.0 and 16.0

MIL-P-15280, For T (Tubing)

C

PHYSICAL PROPERTIES		SEAMLESS RUBBER INSULATION	TEST METHODS
Thermal Conductivity (K) BTU -in/hr-Ft2 - °F (W/mK)	90° F (32° C) Mean Temp 75° F (24° C) Mean Temp 50° F (10° C) Mean Temp	.282 (.041) .277 (.040) .270 (.039)	ASTM C 177 ASTM C 177 ASTM C 177
Operating Temperature Range	Upper	200° F (104° C)	
Flexible to -100° F (-73° C)	Lower	-70° F (-57° C)	
Water Vapor Permeability Dry Cup. Perm-In		.10	ASTM E 96
Water Absorption % weight gain		5%	ASTM D 1056
Ozone Resistant		Pass	ASTM D 1171
Chemical/Solvent Resistance		Good	
Mildew Resistance/Air Erosion		Pass	UL 181

THICKNESS RECOMMENDATIONS* - TO CONTROL CONDENSATION

PIPE SIZE	LINE TEMP		LINE TEMP		LINE TEMP		LINE TEMP	
	50° F	10° C	35° F	2° C	0° F	-18° C	-20° F	-29° C
Normal Conditions (Max 85°F, 29°C - 70% R.H.)								
3/8" ID thru 1-3/8" ID	3/8"	10 mm	1/2"	13 mm	3/4"	19 mm	1"	25 mm
Over 1-3/8" thru 3" IPS	3/8"	10 mm	1/2"	13 mm	1"	25 mm	1"	25 mm
Over 3" IPS thru 4" IPS**	1/2"	13 mm	1/2"	13 mm	1"	25 mm	1-1/4"	32 mm
Over 4" IPS	1/2"	13 mm	3/4"	19 mm	1"	25 mm	1-1/4"	32 mm
Mild Conditions (Max 80°F, 26°C - 50% R.H.)								
3/8" ID thru 2-1/8" ID	3/8"	10 mm	3/8"	10 mm	1/2"	13 mm	1/2"	13 mm
Over 2-1/8" thru 3" IPS	3/8"	10 mm	3/8"	10 mm	1/2"	13 mm	3/4"	19 mm
Over 3" IPS thru 4" IPS**	1/2"	13 mm	1/2"	13 mm	3/4"	19 mm	3/4"	19 mm
Over 4" IPS	1/2"	13 mm	1/2"	13 mm	3/4"	19 mm	3/4"	19 mm
Severe Conditions (Max 90°F, 32°C - 80% R.H.)								
3/8" ID thru 1-1/8" ID	3/4"	19 mm	3/4"	19 mm	1-1/4"	32 mm	1-1/4"	32 mm
Over 1-1/8" ID thru 4" IPS	3/4"	19 mm	1"	25 mm	1-1/2"	38 mm	1-1/2"	38 mm
Over 4" IPS	3/4"	19 mm	1-1/4"	32 mm	1-3/4"	44 mm	2"	50 mm

Seamless Rubber in thickness notes within the specified temperature ranges will prevent condensation on indoor piping under design conditions defined below. Thickness recommendations above 1" can be sleeved to achieve thickness desired.

Normal: Maximum severity of indoor conditions seldom exceed 85° F (29° C) and 70% R.H. in United States.

Mild: Typical conditions are most air-conditioned spaces and arid climates.

Severe: Generally found in areas which excessive moisture is introduced or in poorly ventilated areas where the temperature may be depressed below the ambient. Under conditions of high humidity, additional thickness of insulation may be required.

**Available: Nom. 1/2" or Nom. 3/4" thickness only

SEAMLESS RUBBER "R" VALUES PER SQUARE FOOT					
Pipe OD or Nominal Insulation ID		R Value 3/8" (10 mm) Wall	R Value 1/2" (13 mm) Wall	R Value 3/4" (19 mm) Wall	R Value 1" (25 mm) Wall
3/8"	10 mm	2.3	3.1	4.7	-
1/2"	13 mm	2.2	2.9	4.7	7.6
5/8"	16 mm	2.1	2.7	4.6	7.1
3/4"	19 mm	2.0	2.6	4.6	6.7
7/8"	22 mm	1.9	2.7	4.6	6.5
1-1/8"	29 mm	1.8	2.6	4.6	5.1
1-3/8"	35 mm	1.8	2.7	4.4	5.8
1-1/2" IPS	-	2.0	2.6	4.3	5.5
1-5/8"	41 mm	2.1	2.7	4.3	5.5
2-1/8"	54 mm	1.9	2.6	4.0	5.2
2" IPS	-	2.0	2.7	4.1	5.2
2-1/2" IPS	64 mm	1.9	2.6	3.9	5.0
2-5/8"	67 mm	2.0	2.7	4.0	5.1
3-1/8"	79 mm	1.9	2.5	3.8	4.9
3" IPS	-	2.0	2.8	3.9	5.0
3-5/8"	92 mm	-	2.6	3.7	-
4-1/8"	105 mm	-	2.6	3.7	-
4" IPS	-	-	2.8	3.9	-
5" IPS	-	1.9	2.6	3.9	-
6" IPS	-	-	2.4	3.6	-
8" IPS	-	-	2.4	3.6	-

Note: "R" factors were calculated from using the K factor of .277 (75°F, 24°C mean temp) and nominal wall thickness is each case. Lower operating temperatures will result in improved R values.

Seamless Rubber Pipe Insulation



- Environmentally friendly
- 4 Wall thicknesses: 3/8", 1/2", 3/4" and 1"
- Sizes range from 3/8" ID to 4" IPS
- Sizes not listed are special order. Allow two weeks for delivery.
- CFC-free
- Color - Black with blue ink
- Easy installation, flexible
- CARTON QUANTITIES ONLY

3/8" Wall Thickness

PART NO.	COPPER OD	IPS/PVC	FT/BOX
I60025	1/4"	-	630'
I60038	3/8"	-	612'
I60050	1/2"	1/4"	432'
I60058	5/8"	3/8"	378'
I60075	3/4"	-	342'
I60078	7/8"	1/2"	288'
I60118	1-1/8"	-	216'
I60138	1-3/8"	-	168'
I60158	1-5/8"	1-1/4"	150'
I60200	-	1-1/2"	120'
I60218	2-1/8"	-	96'
I60250	-	2"	84'
I60258	2-5/8"	-	72'
I60300	-	2-1/2"	60'
I60318	3-1/8"	-	60'
I60350	-	3"	48'

1/2" Wall Thickness

PART NO.	COPPER OD	IPS/PVC	FT/BOX
I61038	3/8"	-	456'
I61050	1/2"	1/4"	360'
I61058	5/8"	3/8"	324'
I61075	3/4"	-	270'
I61078	7/8"	1/2"	228'
I61118	1-1/8"	-	156'
I61138	1-3/8"	-	120'
I61158	1-5/8"	1-1/4"	114'
I61200	-	1-1/2"	114'
I61218	2-1/8"	-	102'
I61250	-	2"	66'
I61258	2-5/8"	-	60'
I61300	-	2-1/2"	48'
I61318	3-1/8"	-	48'
I61350	-	3"	36'
I61358	3-5/8"	-	36'
I61418	4-1/8"	-	24'
I61450	-	4"	24'

Seamless Rubber Pipe Insulation



- Environmentally friendly
- 4 Wall thicknesses: 3/8", 1/2", 3/4" and 1"
- Sizes range from 3/8" ID to 4" IPS
- Sizes not listed are special order. Allow two weeks for delivery.
- CFC-free
- Color - Black with blue ink
- Easy installation, flexible
- CARTON QUANTITIES ONLY

3/4" Wall Thickness

PART NO.	COPPER OD	IPS/PVC	FT/BOX
I62038	3/8"	-	294'
I62050	1/2"	1/4"	228'
I62058	5/8"	3/8"	180'
I62075	3/4"	-	144'
I62078	7/8"	1/2"	126'
I62118	1-1/8"	-	90'
I62138	1-3/8"	-	78'
I62158	1-5/8"	1-1/4"	72'
I62200	-	1-1/2"	66'
I62218	2-1/8"	-	60'
I62250	-	2"	48'
I62258	2-5/8"	-	42'
I62300	-	2-1/2"	36'
I62318	3-1/8"	-	36'
I62350	-	3"	30'
I62358	3-5/8"	-	30'
I62418	4-1/8"	-	24'
I62450	-	4"	24'

1" Wall Thickness

PART NO.	COPPER OD	IPS/PVC	FT/BOX
I63058	5/8"	3/8"	108'
I63075	3/4"	-	108'
I63078	7/8"	1/2"	90'
I63118	1-1/8"	-	66'
I63138	1-3/8"	-	60'
I63158	1-5/8"	1-1/2"	54'
I63200	-	1-1/2"	42'
I63218	2-1/8"	-	42'
I63250	-	2"	36'
I63258	2-5/8"	-	36'
I63300	-	2-1/2"	36'
I63318	3-1/8"	-	30'
I63350	-	3"	30'
I63358	3-5/8"	-	30'

C

Double Stick Rubber Pipe Insulation



- Environmentally friendly
- 4 Wall thicknesses: 3/8", 1/2", 3/4" and 1"
- Sizes range from 3/8" ID to 4" IPS
- Split with adhesive on both sides
- CFC-free
- Color - Black with blue ink
- Easy installation, flexible
- CARTON QUANTITIES ONLY

3/8" Wall Thickness

PART NO.	COPPER OD	IPS/PVC	FT/BOX
I80038	3/8"	3/8"	570'
I80050	1/2"	1/2"	402'
I80058	5/8"	5/8"	348'
I80034	3/4"	3/4"	318'
I80078	7/8"	7/8"	288'
I80118	1-1/8"	1-1/8"	216'
I80138	1-3/8"	1-3/8"	150'
I80150	1-1/2" IPS	1-1/2" IPS	120'
I80158	1 5/8"	1 5/8"	132'
I80200	2" IPS	2" IPS	78'
I80218	2 1/8"	2 1/8"	78'
I80250	2-1/2" IPS	2-1/2" IPS	60'
I80258	2-5/8"	2-5/8"	72'

1/2" Wall Thickness

PART NO.	COPPER OD	IPS/PVC	FT/BOX
I81038	3/8"	3/8"	420'
I81050	1/2"	1/2"	312'
I81058	5/8"	5/8"	312'
I81034	3/4"	3/4"	270'
I81078	7/8"	7/8"	216'
I81118	1-1/8"	1-1/8"	150'
I81138	1-3/8"	1-3/8"	120'
I81150	1-1/2" IPS	1-1/2" IPS	108'
I81158	1 5/8"	1 5/8"	108'
I81200	2" IPS	2" IPS	60'
I81218	2-1/8"	2-1/8"	60'
I81250	2-1/2" IPS	2-1/2" IPS	48'
I81258	2-5/8"	2-5/8"	60'
I81300	3" IPS	3" IPS	36'
I81318	3-1/8"	3-1/8"	48'
I81358	3-5/8"	3-5/8"	36'
I81400	4" IPS	4" IPS	24'
I81418	4-1/8"	4-1/8"	24'

Double Stick Rubber Pipe Insulation



- Environmentally friendly
- 4 Wall thicknesses: 3/8", 1/2", 3/4" and 1"
- Sizes range from 3/8" ID to 4" IPS
- Split with adhesive on both sides
- CFC-free
- Color - Black with blue ink
- Easy installation, flexible
- CARTON QUANTITIES ONLY

3/4" Wall Thickness

PART NO.	COPPER OD	IPS/PVC	FT/BOX
I82038	3/8"	3/8"	258'
I82050	1/2"	1/2"	192'
I82058	5/8"	5/8"	180'
I82034	3/4"	3/4"	120'
I82078	7/8"	7/8"	126'
I82118	1-1/8"	1-1/8"	90'
I82138	1-3/8"	1-3/8"	78'
I82150	1-1/2" IPS	1-1/2" IPS	66'
I82158	1-5/8"	1-5/8"	72'
I82200	2" IPS	2" IPS	48'
I82218	2-1/8"	2-1/8"	60'
I82250	2-1/2" IPS	2-1/2" IPS	36'
I82258	2-5/8"	2-5/8"	42'
I82300	3" IPS	3" IPS	30'
I82318	3-1/8"	3-1/8"	36'
I82358	3-5/8"	3-5/8"	30'
I82400	4" IPS	4" IPS	24'
I82418	4-1/8"	4-1/8"	24'

1" Wall Thickness

PART NO.	COPPER OD	IPS/PVC	FT/BOX
I83058	5/8"	5/8"	108'
I83034	3/4"	3/4"	78'
I83078	7/8"	7/8"	78'
I83118	1-1/8"	1-1/8"	66'
I83138	1-3/8"	1-3/8"	60'
I83150	1-1/2" IPS	1-1/2" IPS	42'
I83158	1-5/8"	1-5/8"	42'
I83200	2" IPS	2" IPS	36'
I83218	2-1/8"	2-1/8"	42'
I83250	2-1/2" IPS	2-1/2" IPS	36'
I83258	2-5/8"	2-5/8"	36'
I83300	3" IPS	3" IPS	30'
I83318	3-1/8"	3-1/8"	30'
I83358	3-5/8"	3-5/8"	30'
I83418	4-1/8"	4-1/8"	18'

C

CLOSED CELL Pipe Insulation



DESCRIPTION

Closed Cell Pipe Insulation is a flexible and easy-to-apply tubing product available in Semi-Slit and Self-Sealing styles. These chemically inert pipe insulations are specially formulated to retard heat gain and their closed-cell structures allow them to function as efficient insulators. The Self-Sealing version has yellow self-seal release liner that is both easy to see and peel.

APPLICATIONS

To reduce unwanted heat loss or heat gain, control condensation, decrease plumbing noise and maximize energy savings. They can be used on hot and cold water lines, refrigeration lines, air conditioning lines; line set tubing, condenser coils, and connection and distribution lines.

Closed Cell Pipe Insulation has low thermal conductivity and a very low water vapor transmission rate. This low density product demonstrates excellent thermal, physical and chemical resistant properties, and has a broad service temperature range between -90° F and 180° F (-68° C and 82° C). It can be installed in commercial, industrial, and residential insulation projects.

INSTALLATION

Closed Cell Pipe Insulation is installed by sliding the stick over pipe or tubing. For existing lines, the insulation should be slit lengthwise and fitted over the pipe. When in place, make sure all seams are adhered with contact adhesive and pressed together to form a seal. The Self-Sealing version does not require adhesive. Fittings can be fabricated from miter-cut tubular sections. Closed Cell Pipe Insulation is easily cut with a sharp knife.

OUTDOOR APPLICATIONS

Outdoor applications require a protective coating (high quality exterior acrylic latex paint) for optimum performance. For best appearance, two coats are recommended.

UNDERGROUND

For buried lines above the water table, use a clean fill such as sand (3"-5" layer) to protect Closed Cell Pipe Insulation before backfilling. It is recommended that all materials to be buried are properly sealed at all seams and butt joints with Contact Adhesive. For optimum performance, the lines should be encased in conduit to protect them from problems associated with ground water.

RESISTANCE TO MOISTURE VAPOR FLOW

The closed-cell structure effectively retards the flow of moisture vapor, and is considered a low transmittance vapor retarder. For most applications, Closed Cell Pipe Insulation needs no additional protection.

Additional vapor barrier protection may be necessary for Closed Cell Pipe Insulation when installed on low temperature surfaces or where it is exposed to continuous high humidity.

FLAME AND SMOKE RATING

Closed Cell Pipe Insulation in wall thicknesses of 1" (25mm) and below has a flame spread rating of 25 or less and a smoke development rating of 50 or less as tested by ASTM E 84; CAN/ULC-S102.2-M88 Method of Testing entitled: "Surface Burning Characteristics of Building Materials."

Numerical flammability ratings alone may not define the performance of products under actual fire conditions. They are provided only for use in the selection of products to meet limits specified, when compared to a known standard.

SPECIFICATION COMPLIANCE

Complies with requirements of:

ASTM E 84; CAN/ULC S102.2

ASTM D 1622

ASTM D 1171

ASTM C 177 or C518

ASTM E 96

PHYSICAL DATA	PROPERTIES	TEST METHODS
Material	Closed Cell Polyolefin	-
Color	Charcoal	-
Upper Use Limit	180°F (82°C) constant	-
Lower Use Limit	-90°F (-68°C)	-
Density	1.5 lbs/ft ³	ASTM D 1622
Ozone Resistant	Good	ASTM D 1171
Thermal Conductivity (K)	at 75° F (24°C) Mean Temp	ASTM C 177 or C 518
BTU-in/hr-ft ² - F° (W/m-K)	0.230 (0.033)	-
Water Absorption	0.02% by Volume	ASTM E 96
Flame Speed	Less than 25	ASTM E 84; CAN/ULC-S102.2-M88
Smoke Classification	Less than 50	ASTM E 84; CAN/ULC-S102.2-M88

THICKNESS RECOMMENDATIONS* - TO CONTROL CONDENSATION

PIPE SIZE	LINE TEMP		LINE TEMP		LINE TEMP		LINE TEMP	
	50° F	10° C	35° F	2° C	0° F	-18° C	-20° F	-29° C
Normal Conditions (Max 85°F, 29°C - 70% R.H.)								
3/8" ID thru 1-3/8" ID	3/8"	10 mm	1/2"	13 mm	3/4"	19 mm	1"	25 mm
Over 1-3/8" thru 3" IPS	3/8"	10 mm	1/2"	13 mm	1"	25 mm	1"	25 mm
Over 3" IPS thru 4" IPS**	3/8"	10 mm	1/2"	13 mm	1"	25 mm	1"	25 mm
Over 4" IPS	1/2"	13 mm	3/4"	19 mm	1"	25 mm	1-1/4"	32 mm
Mild Conditions (Max 80°F, 26°C - 50% R.H.)								
3/8" ID thru 2-1/8" ID	3/8"	10 mm	3/8"	10 mm	3/8"	10 mm	1/2"	13 mm
Over 2-1/8" thru 3" IPS	3/8"	10 mm	3/8"	10 mm	3/8"	10 mm	1/2"	13 mm
Over 3" IPS thru 4" IPS**	3/8"	10 mm	3/8"	10 mm	1/2"	13 mm	3/4"	19 mm
Over 4" IPS	3/8"	10 mm	1/2"	13 mm	1/2"	13 mm	3/4"	19 mm
Severe Conditions (Max 90°F, 32°C - 80% R.H.)								
3/8" ID thru 1-1/8" ID	3/4"	19 mm	3/4"	19 mm	1-1/4"	32 mm	1-1/4"	32 mm
Over 1-1/8" ID thru 4" IPS	3/4"	19 mm	1"	25 mm	1-1/2"	38 mm	1-1/2"	38 mm
Over 4" IPS	3/4"	19 mm	1"	25 mm	1-1/2"	38 mm	2"	50 mm

Closed Cell Pipe Insulation in thickness notes within the specified temperature ranges will prevent condensation on indoor piping under design conditions defined below. Thickness recommendations above 1" can be sleeved to achieve thickness desired.

Normal: Maximum severity of indoor conditions seldom exceed 85° F (29° C) and 70% R.H. in United States.

Mild: Typical conditions are most air-conditioned spaces and arid climates.

Severe: Generally found in areas which excessive moisture is introduced or in poorly ventilated areas where the temperature may be depressed below the ambient. Under conditions of high humidity, additional thickness of insulation may be required.

**Available: Nom. 1/2" or Nom. 3/4" thickness only

CLOSED CELL "R" VALUES PER SQUARE FOOT					
Pipe OD or Nominal Insulation ID		R Value 3/8" (10 mm) Wall	R Value 1/2" (13 mm) Wall	R Value 3/4" (19 mm) Wall	R Value 1" (25 mm) Wall
3/8"	10 mm	2.687	3.844	-	-
1/2"	13 mm	2.490	3.582	6.027	-
5/8"	16 mm	2.357	3.375	5.653	8.189
3/4"	19 mm	2.680	3.223	5.374	7.767
7/8"	22 mm	2.187	3.107	5.155	7.435
1-1/8"	29 mm	2.082	4.835	4.835	6.941
1-3/8"	35 mm	2.011	2.822	4.610	6.588
1-5/8"	41 mm	1.959	2.737	4.420	6.323
1-7/8"	-	1.920	2.672	4.313	6.115
2-1/8"	54 mm	1.889	2.620	4.209	5.948
2-3/8"	-	1.864	2.578	4.124	5.810
2-5/8"	67 mm	1.844	2.544	4.053	5.695
2-7/8"	-	1.827	2.514	3.993	5.596
3-1/8"	79 mm	1.812	2.490	3.942	5.512
3-1/2"	-	-	2.459	3.877	5.404
3-5/8"	92 mm	-	2.449	-	5.373
4"	105 mm	-	2.425	-	-
4-1/8"	-	-	2.418	-	5.264
4-1/2"	-	-	2.399	-	5.196

Note: "R" factors were calculated from using the K factor of .230 (75°F, 24°C mean temp) and nominal wall thickness is each case. Lower operating temperatures will result in improved R values.

Semi-Slit Pipe Insulation



- 100% closed cell polyethylene
- For outdoor use, paint with a high quality exterior acrylic latex paint
- UPS shippable cartons - CARTON QUANTITIES ONLY

SPECIFICATIONS:

Density: 1.5 lbs./cubic foot; Mold growth: None;
 Temperature Range: -90° to 180°F; Flame/Smoke:
 25/50; Water vapor permeability: less than .02
 inches; Ozone resistance: Good

3/8" Wall Thickness

PART NO.	NOMINAL ID	R VALUES	CTS	IPS	FT/BOX
I50058	5/8"	2.357	1/2"	3/8"	408'
I50075	3/4"	2.680	5/8"	-	360'
I50078	7/8"	2.187	3/4"	1/2"	300'
I50118	1-1/8"	2.082	1"	3/4"	240'
I50138	1-3/8"	2.011	1-1/4"	1"	192'
I50158	1-5/8"	1.959	1-1/2"	1-1/4"	132'
I50178	2"	1.920	-	1-1/2"	108'
I50218	2-1/8"	1.889	2"	-	90'
I50238	2-3/8"	1.864	-	2"	90'
I50258	2-5/8"	1.844	2-1/2"	-	72'

1/2" Wall Thickness

PART NO.	NOMINAL ID	R VALUES	CTS	IPS	FT/BOX
I51058	5/8"	3.375	1/2"	3/8"	306'
I51078	7/8"	3.107	3/4"	1/2"	240'
I51118	1-1/8"	4.835	1"	3/4"	180'
I51138	1-3/8"	2.822	1-1/4"	1"	150'
I51158	1-5/8"	2.737	1-1/2"	1-1/4"	120'
I51178	2"	2.672	-	1-1/2"	90'
I51218	2-1/8"	2.620	2"	-	84'
I51238	2-3/8"	2.578	-	2"	66'
I51258	2-5/8"	2.544	2-1/2"	-	60'

3/4" Wall Thickness

PART NO.	NOMINAL ID	R VALUES	CTS	IPS	FT/BOX
I54050	1/2"	6.027	3/8"	1/4"	204'
I54058	5/8"	5.653	1/2"	3/8"	180'
I54075	3/4"	5.374	5/8"	1/2"	168'
I54078	7/8"	5.155	3/4"	-	156'
I54118	1-1/8"	4.835	1"	-	102'
I54138	1-3/8"	4.610	1-1/4"	1"	90'
I54158	1-5/8"	4.420	1-1/2"	1-1/4"	84'
I54178	2"	4.313	-	1-1/2"	66'
I54218	2-1/8"	4.209	2"	-	54'
I54258	2-5/8"	4.053	2-1/2"	-	48'

1" Wall Thickness

PART NO.	NOMINAL ID	R VALUES	CTS	IPS	FT/BOX
I55058	5/8"	8.189	1/2"	3/8"	108'
I55075	3/4"	7.767	5/8"	1/2"	102'
I55078	7/8"	7.435	3/4"	-	90'
I55118	1-1/8"	6.941	1"	-	90'
I55158	1-5/8"	6.323	1-1/2"	1-1/4"	60'
I55178	2"	6.115	-	1-1/2"	54'
I55218	2-1/8"	5.948	2"	-	48'
I55258	2-5/8"	5.695	2-1/2"	-	42'

PART NO.	NOMINAL ID	R VALUES	CTS	IPS	FT/BOX
I57058	5/8"	8.189	1/2"	3/8"	108'
I57078	7/8"	7.435	3/4"	1/2"	90'
I57115	3/4"	7.767	5/8"	-	102'
I57118	1-1/8"	6.941	1"	-	90'
I57138	1-3/8"	6.588	1-1/4"	1"	72'
I57158	1-5/8"	6.323	1-1/2"	1-1/4"	60'
I57178	2"	6.115	-	1-1/2"	54'
I57218	2-1/8"	5.948	2"	-	56'
I57238	2-3/8"	5.810	-	2"	42'
I57258	2-5/8"	5.695	2-1/2"	-	36'

PART NO.	NOMINAL ID	R VALUES	CTS	IPS	FT/BOX
I52058	5/8"	2.357	1/2"	3/8"	408'
I52034	3/4"	2.680	5/8"	-	360'
I52078	7/8"	2.187	3/4"	1/2"	300'
I52118	1-1/8"	2.082	1"	3/4"	240'
I52138	1-3/8"	2.011	1-1/4"	1"	192'
I52158	1-5/8"	1.959	1-1/2"	1-1/4"	132'
I52178	2"	1.920	-	1-1/2"	108'
I52218	2-1/8"	1.889	2"	-	90'
I52238	2-3/8"	1.864	-	2"	90'
I52258	2-5/8"	1.844	2-1/2"	-	72'
I52318	3-1/8"	1.812	3"	-	54'
I52358	3-5/8"	-	-	-	42'

Self-Sealing Pipe Insulation



- 100% closed cell polyethylene
- Complete seal on hot or cold pipe
- Two strips of self-adhesive seal easily at any length
- UPS shippable cartons - CARTON QUANTITIES ONLY

SPECIFICATIONS:

Density: 1.5 lbs./cubic foot; Mold growth: None;
 Temperature Range: -90° to 180°F; Flame/Smoke:
 25/50; Water vapor permeability: less than .02
 inches; Ozone resistance: Good

3/8" Wall Thickness

PART NO.	NOMINAL ID	R VALUES	CTS	IPS	FT/BOX
I52058	5/8"	2.357	1/2"	3/8"	408'
I52034	3/4"	2.680	5/8"	-	360'
I52078	7/8"	2.187	3/4"	1/2"	300'
I52118	1-1/8"	2.082	1"	3/4"	240'
I52138	1-3/8"	2.011	1-1/4"	1"	192'
I52158	1-5/8"	1.959	1-1/2"	1-1/4"	132'
I52178	2"	1.920	-	1-1/2"	108'
I52218	2-1/8"	1.889	2"	-	90'
I52238	2-3/8"	1.864	-	2"	90'
I52258	2-5/8"	1.844	2-1/2"	-	72'
I52318	3-1/8"	1.812	3"	-	54'
I52358	3-5/8"	-	-	-	42'

1/2" Wall Thickness

PART NO.	NOMINAL ID	R VALUES	CTS	IPS	FT/BOX
I53038	3/8"	3.844	1/4"	-	444'
I53050	1/2"	3.582	3/8"	1/4"	360'
I53058	5/8"	3.375	1/2"	3/8"	306'
I53075	3/4"	3.223	3/4"	1/2"	270'
I53078	7/8"	3.107	3/4"	1/2"	240'
I53118	1-1/8"	4.835	1"	3/4"	180'
I53138	1-3/8"	2.822	1-1/4"	1"	150'
I53158	1-5/8"	2.737	1-1/2"	1-1/4"	120'
I53178	2"	2.672	-	1-1/2"	90'
I53218	2-1/8"	2.620	2"	-	84'
I53238	2-3/8"	2.578	-	2"	66'
I53258	2-5/8"	2.544	2-1/2"	-	60'
I53318	3-1/8"	2.490	3"	-	48'
I53312	3-1/2"	2.459	-	3"	42'
I53358	3-5/8"	2.449	3-1/2"	-	42'
I53418	4-1/8"	2.418	4"	-	30'
I53412	4-1/2"	2.399	-	4"	30'

3/4" Wall Thickness

PART NO.	NOMINAL ID	R VALUES	CTS	IPS	FT/BOX
I56058	5/8"	5.653	1/2"	3/8"	180'
I56075	3/4"	5.374	5/8"	1/2"	168'
I56078	7/8"	5.155	3/4"	1/2"	156'
I56118	1-1/8"	4.835	1"	3/4"	102'
I56138	1-3/8"	4.610	1-1/4"	1"	90'
I56158	1-5/8"	4.420	1-1/2"	1-1/4"	84'
I56218	2-1/8"	4.209	2"	-	54'

1" Wall Thickness

PART NO.	NOMINAL ID	R VALUES	CTS	IPS	FT/BOX
I57058	5/8"	8.189	1/2"	3/8"	108'
I57078	7/8"	7.435	3/4"	1/2"	90'
I57115	3/4"	7.767	5/8"	-	102'
I57118	1-1/8"	6.941	1"	-	90'
I57138	1-3/8"	6.588	1-1/4"	1"	72'
I57158	1-5/8"	6.323	1-1/2"	1-1/4"	60'
I57178	2"	6.115	-	1-1/2"	54'
I57218	2-1/8"	5.948	2"	-	56'
I57238	2-3/8"	5.810	-	2"	42'
I57258	2-5/8"	5.695	2-1/2"	-	36'

Poly Pipe Insulation Tees and Elbows



- 100% closed cell polyethylene
- Complete seal on hot or cold pipe
- Two strips of self-adhesive to seal easily
- UPS shippable cartons - CARTON QUANTITIES ONLY



SPECIFICATIONS:

Density: 1.5 lbs./cubic foot; Mold growth: None;
Temperature Range: -90° to 180°F; Flame/Smoke:
25/50; Water vapor permeability: less than .02
inches; Ozone resistance: Good

PART NO.	DESCRIPTION	WALL THICKNESS	CTN/MSTR
I59050	1/2" tee	3/8"	1/16
I59075	3/4" tee	3/8"	1/12
I59100	1" tee	3/8"	1/12
I59125	1-1/4" tee	3/8"	1/8
I59150	1/2" elbow	3/8"	1/32
I59175	3/4" elbow	3/8"	1/20
I59200	1" elbow	3/8"	1/16
I59225	1-1/4" elbow	3/8"	1/12

Insulation Contact Adhesive



- Brush top cans
- For use with rubber insulation only
- MOTOR FREIGHT ONLY/FLAMMABLE
- CARTON QUANTITIES ONLY

PART NO.	DESCRIPTION	CTN/MSTR
IA1050	Fast tack 1/2 pint	12/48
IA1100	Fast tack 1 pint	12/24
IA2050	Slow tack 1/2 pint	12/48
IA2100	Slow tack 1 pint	12/24

Insulation Protective Coating



- Clear

PART NO.	DESCRIPTION	CTN/MSTR
IPC004	1 gallon	1/4

Insulation Tape



- Gray
- Adhesive only on one side

PART NO.	DESCRIPTION	CTN/MSTR
INT001	1/8" x 2" x 30' cork tape	1/12
INT002	1/8" x 2" x 30' tape	1/12

Flanged Dielectric Union



- Temperature range: 180°F at 200 PSI
- Maximum temperature 200°F
- Lead free

PART NO.	FIP x COPPER SWEAT	CTN/MSTR
D06250	2-1/2" x 2-1/2"	1/4
D06300	3" x 3"	1/4
D06400	4" x 4"	1/2

Thermal Expansion Tank



- Designed for the protection of potable hot water systems
- Install between the backflow preventer and the water heater
- Six year warranty

SPECIFICATIONS:

Factory pre-charge: 35psi
System connection: 304 Stainless Steel
Diaphragm: Butyl Rubber
Liner Material: Food Grade Polypropylene
Max. Operating Temperature: 200°F
Max. Operating Pressure: 150psi

PART NO.	DESCRIPTION	CTN. QTY.	PALLET QTY.
R15202	2 gallon tank	1	150
R15204	4-1/2 gallon tank	1	80

Water Heater Grounding Kit



- Kit includes 2 bare bronze clamps
- Fits 1/2" to 1" pipe
- 6 gauge copper wire

PART NO.	DESCRIPTION	CTN/MSTR
J36500	Kit with 12" copper wire	1/6
J36501	Kit with 24" copper wire	1/6

Dielectric Union



Female x Sweat



Male x Sweat

- Zinc plated forged steel
- Prevents electrolysis or galvanic action when connecting dissimilar metals
- Residential or commercial use
- Solder ends conform to ANSI B16.19
- EPDM washer, ABS fiber sleeve
- Threads conform to ANSI B2.1
- Pressure rated at 250 PSI at 180°F
- Lead Free

Female x Sweat

PART NO.	FIP x COPPER SWEAT	OD	CTN/MSTR
D06050	1/2" x 1/2"	5/8"	24/144
D06075	3/4" x 3/4"	7/8"	24/96
D06100	1" x 1"	1-1/8"	12/96
D06125	1-1/4" x 1-1/4"	1-3/8"	6/48
D06150	1-1/2" x 1-1/2"	1-5/8"	6/48
D06200	2" x 2"	2-1/8"	6/18

Reducing

PART NO.	FIP x COPPER SWEAT	OD	CTN/MSTR
D06350	3/4" x 1/2"	5/8"	24/96

Male x Sweat

PART NO.	MIP x COPPER SWEAT	OD	CTN/MSTR
D06005	1/2" x 1/2"	7/8"	24/96
D06750	3/4" x 3/4"	7/8"	24/96

Reducing

PART NO.	MIP x COPPER SWEAT	OD	CTN/MSTR
D06755	3/4" x 1/2"	5/8"	24/72

Universal Copper Thermocouple



- All copper with brass fittings
- Adaptable to 5 different pilot valves
- Kit includes 2 clips and nuts
- Individually carded

PART NO.	DESCRIPTION	CTN/MSTR
J36118	18" copper thermocouple	10/100
J36124	24" copper thermocouple	10/100
J36130	30" copper thermocouple	1/10
J36136	36" copper thermocouple	1/10
J36148	48" copper thermocouple	1/10

Items marked with the Jones Stephens logo are "You Need It... We Got It" Items.

Gasket and Insert for Dielectric Union



Insert



Gasket

- For water
- 200°F temperature rating
- CARTON QUANTITIES ONLY

PART NO.	DESCRIPTION	CTN/MSTR
D06800	1/2" insert	1/1
D06801	3/4" insert	1/500
D06802	1" insert	1/100
D06803	1-1/4" insert	1/1
D06804	1-1/2" insert	1/1
D06805	2" insert	1/1
D06850	1/2" gasket	1/1000
D06875	3/4" gasket (EPDM rubber)	1/1000
D06900	1" gasket	1/1000
D06901	1-1/4" gasket	1/1000
D06902	1-1/2" gasket	1/1000
D06903	2" gasket	1/1000

Dielectric Nipple



- Electroplated steel casing with non-corrosion thermoplastic lining • 180° maximum temperature
- Prevents corrosion, lime and scale buildup
- Adds years of life to any water system
- For use on water heaters, dishwashers, water filtration systems

PART NO.	SIZE	CTN/MSTR
D06753	3/4" MIP x 3" length	50/100
D06450	1/2" MIP x 3" length	50/100
D06500	1" MIP x 3" length	25/50
D06510	1" MIP x 4" length	25/50
D06525	1-1/4" MIP x 4" length	25/50
D06550	1-1/2" MIP x 4" length	5/25
D06600	2" MIP x 4" length	5/25
D06650	2-1/2" MIP x 6" length	5/10
D06700	3" MIP x 6" length	5/10

Braided Stainless Steel Water Heater Connector

- UPC listed
- Lead Free



PART NO.	FIP x LENGTH	CTN/MSTR
S04350	3/4" x 12"	10/40
S04351	3/4" x 18"	10/40
S04352	3/4" x 24"	10/40



PART NO.	FIP x COMP x LENGTH	CTN/MSTR
S04353	3/4" x 3/4" x 12"	10/40
S04354	3/4" x 3/4" x 18"	10/40
S04355	3/4" x 3/4" x 24"	10/40



PART NO.	FIP x MIP x LENGTH	CTN/MSTR
S04356	3/4" x 3/4" x 12"	10/40
S04357	3/4" x 3/4" x 18"	10/40
S04358	3/4" x 3/4" x 24"	10/40



PART NO.	MIP x COMP x LENGTH	CTN/MSTR
S04359	3/4" x 3/4" x 12"	10/40
S04360	3/4" x 3/4" x 18"	10/50

Items marked with the Jones Stephens logo are "You Need It... We Got It" Items.

Corrugated Water Heater Connector

- Corrugated for easy flex on water heaters and softeners
- Includes rubber washers



Copper



PART NO.	FPT x LENGTH	CTN/MSTR
J34712	3/4" x 12"	1/50
J34715	3/4" x 15"	1/50
J34718	3/4" x 18"	1/50
J34724	3/4" x 24"	1/50



PART NO.	FIP x SWT x LENGTH	CTN/MSTR
J35712	3/4" x 3/4" x 12"	25/50
J35715	3/4" x 3/4" x 15"	25/50
J35718	3/4" x 3/4" x 18"	25/50
J35724	3/4" x 3/4" x 24"	25/50



PART NO.	FIP x MIP x LENGTH	CTN/MSTR
J36712	3/4" x 3/4" x 12"	1/25
J36715	3/4" x 3/4" x 15"	1/25
J36718	3/4" x 3/4" x 18"	1/25
J36724	3/4" x 3/4" x 24"	1/25

Stainless Steel



PART NO.	MIP x FIP x LENGTH	CTN/MSTR
J38712	3/4" x 3/4" x 12"	25/50
J38715	3/4" x 3/4" x 15"	25/50
J38718	3/4" x 3/4" x 18"	25/50
J38724	3/4" x 3/4" x 24"	25/50



PART NO.	FIP x FIP x LENGTH	CTN/MSTR
J39712	3/4" x 3/4" x 12"	25/50
J39715	3/4" x 3/4" x 15"	25/50
J39718	3/4" x 3/4" x 18"	25/50
J39724	3/4" x 3/4" x 24"	25/50

Push On Water Heater Connector

- Leak-free, tool-free & solvent free
- Approved for behind-the-wall installation
- Fittings may be reused if necessary
- Internal PEX tube insert provided for Perfect PEX connections
- For use with hot and cold potable water
- Operation temperature 0°F to 200°F. 200 PSI
- Lead Free



PART NO.	PF x FIP x LENGTH	CTN/MSTR
C76605LF	1/2" x 3/4" x 12"	10/80
C76606LF	1/2" x 3/4" x 15"	10/80
C76607LF	1/2" x 3/4" x 18"	10/80
C76608LF	1/2" x 3/4" x 24"	10/80
C76612LF	3/4" x 3/4" x 12"	10/80
C76613LF	3/4" x 3/4" x 15"	10/80
C76614LF	3/4" x 3/4" x 18"	10/80
C76615LF	3/4" x 3/4" x 24"	10/80
C76616LF	1/2" valve x 3/4" x 18"	1/10
C76617LF	3/4" valve x 3/4" x 18"	1/10

Stand-Rite Water Heater Stand



- 14 gauge galvanized steel
- Lab tested
- Heavy duty
- Corrosion resistant
- Top 21.5" x 21.5"
- Rated up to 650 pounds
- For water heaters up to 65 gallons
- Includes mounting clips for securing to wall/floor
- Quick assembly

PART NO.	DESCRIPTION	CTN/MSTR
J36400	Water heater stand	1/1

Water Heater Safety Pan



- High impact plastic
- 1" pan adapter (J34800) included
- 2-1/2" depth
- Southern Building Code and natural gas approved
- CARTON QUANTITIES ONLY

PART NO.	BOTTOM ID	TOP ID	CTN/MSTR
J36018	19"	20-1/2"	1/10
J36022	22"	22-1/2"	1/10
J36024	24"	25-1/2"	1/10
J36026	26"	27-1/2"	1/10
J36030	30"	31-1/2"	1/5

Galvanized Hot Water Heater Pan



- 24 gauge
- Flared sides
- 1" pan adapter (J34800) included

PART NO.	DESCRIPTION	CTN/MSTR
J37022	22" x 22" x 4" water heater pan	1/1
J37024	24" x 24" x 4" water heater pan	1/1
J37026	26" x 26" x 4" water heater pan	1/1
J37028	28" x 28" x 4" water heater pan	1/1
J37030	30" x 30" x 4" water heater pan	1/1

Water Heater Pan



Seamless Galvanized Corner



- Seamless galvanized water heater pans are folded not welded
- 1" pan adapter (J34800) included
- One piece stamped aluminum .032 mil (20 gauge)
- Aluminum pans comply with SBCCI, sec. 1213.7

PART NO.	DESCRIPTION	CTN/MSTR
J38020	20" round water heater pan (aluminum)	1/6
J38022	22" round water heater pan (aluminum)	1/6
J38024	24" round water heater pan (aluminum)	1/6
J38026	26" round water heater pan (aluminum)	1/6
J38030	30" round water heater pan (aluminum)	1/5
J39019	19" seamless water heater pan (galvanized)	1/1
J39023	23" seamless water heater pan (galvanized)	1/1
J39027	27" seamless water heater pan (galvanized)	1/1
J39030	30" seamless water heater pan (galvanized)	1/1

Water Heater Pan Adapter



- 1" PVC
- Washer and locknut
- Fits all Jones Stephens pans

PART NO.	DESCRIPTION	CTN/MSTR
J34800	1" Adapter	1/25

Run-Off Tube



- For water heaters
- Electroplated fittings
- 230°F temperature rating
- Hand tighten to T and P valve
- Meets AMSE A112.4.1
- UL listed
- J34970 is sold in CARTON QUANTITIES ONLY



PART NO.	DESCRIPTION	CTN/MSTR
J34975	3/4" NPT x 60" side mount	1/100
J34980	3/4" NPT top mount	1/25
J34970	3/4" NPT x 60" side mount	12/12

Gas Testing Equipment



- Large 4" face
- Class 1A gauge
- 5 lb. gas test gauge/15 lb. gas test gauge
- 1/10 # increments
- Inches of mercury scale
- External set hand
- Bellows design
- 1/4 NPT connection
- Gauge meets all requirements of the City of Houston code Word 94-108, Section 1204.3.2, revised January 18, 2001
- ALL SALES FINAL; NO WARRANTY; NO RETURN

PART NO.	DESCRIPTION	CTN/MSTR
G60055	15 lb. gas test gauge only	1/20
G60005	5 lb. gas test gauge only	1/20

Liquid Filled Pressure Gauge



- Polished 304 stainless steel case with vent plug
- 2-1/2" face (glass)
- +/- 1.5% accuracy
- Glycerin filled for use where vibration or pressure pulsation occur
- -50 to 150°F operating temperature
- 1/4" NPT bottom connection

PART NO.	DESCRIPTION	CTN/MSTR
J40553	0-30 PSI	1/50
J40554	0-60 PSI	1/50
J40555	0-100 PSI	1/50
J40556	0-200 PSI	1/50
J40557	0-300 PSI	1/50

Water Heater Stand



- Galvanized
- Snap-in legs
- Easy to assemble
- Rating approval at 2,000 lbs. static weight

PART NO.	DESCRIPTION	CTN/MSTR
J36200	18" square x 17" high water heater stand	1/4



- 3/4 tubular steel construction
- No assembly required
- Non-rust paint
- 800 lbs. static weight

PART NO.	DESCRIPTION	CTN/MSTR
J36300	25-1/2" x 19" high water heater stand	1/1
J36250	28-3/8" x 18-3/16" high water heater stand	1/1

Pressure Gauge



- Steel case
- Shatterproof face
- 1/4" MIP brass lower connection
- Applicable with air, water, oil and gas - anything which does not attack brass
- Not for use on oxygen service
- Class 2.5-2% accuracy
- Individually boxed

PART NO.	FACE SIZE	PRESSURE RATING	CTN/MSTR
G60015	2"	15 PSI	1/100
G60030	2"	30 PSI	1/100
G60060	2"	60 PSI	1/100
G60100	2"	100 PSI	1/100
G60160	2"	160 PSI	1/100
G60200	2"	200 PSI	1/100
G60300	2"	300 PSI	1/100
G61015	2-1/2"	15 PSI	1/100
G61030	2-1/2"	30 PSI	1/60
G61060	2-1/2"	60 PSI	1/100
G61100	2-1/2"	100 PSI	1/100
G61160	2-1/2"	160 PSI	1/100
G61200	2-1/2"	200 PSI	1/100
G61300	2-1/2"	300 PSI	1/100
G62030	3-1/2"	30 PSI	1/50
G62060	3-1/2"	60 PSI	1/50
G62100	3-1/2"	100 PSI	1/50
G62200	3-1/2"	200 PSI	1/50
G62300	3-1/2"	300 PSI	1/50

Pigtail Syphon



- Steel construction
- For use with gauges on steam line
- 1/4" MPT x 1/4" MPT

PART NO.	DESCRIPTION	CTN/MSTR
G60000	Straight	20/200
G60001	90° Angle	10/200

Water Test Gauge



- Steel case with 2-1/2" shatterproof face
- 3/4" female brass hose connection
- Individually boxed

PART NO.	DESCRIPTION	CTN/MSTR
J66300	300 PSI	1/50
J66301	300 PSI with indicator arm	1/50
J66302	160 PSI with indicator arm	1/50

Sillcock/Water or Gas Test Gauge Assembly



- Steel case with 2" shatterproof face
- Brass air valve
- Adapts to 3/4" male garden hose or 3/4" MIP
- Comes with garden hose adapter
- Individually boxed

PART NO.	DESCRIPTION	CTN/MSTR
G64101	200 PSI	1/50

Items marked with the Jones Stephens logo are "You Need It... We Got It" Items.

5 Pound Gas Test Gauge



- 1/4" NPT
- 2-1/2" diaphragm
- 1/10 # increments
- For building code inspection

PART NO.	DESCRIPTION	CTN/MSTR
G61005	5 lb. gas test gauge	1/100

Gas Test Gauge



- 2" steel case gauge on 15 lb.
- 5 lb. is marked in 1/10 lb. increments
- 15 lbs. is marked in 1/10 lb. increments
- Plated body with 3/4" FIP inlet
- 2 1/2" diaphragm on 5 lb.
- Adapts to 3/4" MPT
- Brass air valve
- Individually boxed

PART NO.	DESCRIPTION	CTN/MSTR
G64015	15 lb. gas test gauge assembly	1/50
G64005	5 lb. gas test gauge assembly	1/50

Test Gauge Assembly



- Bell type

PART NO.	DESCRIPTION	CTN/MSTR
G66015	15# x 3/4" FIP	1/50
G66030	30# x 3/4" FIP	1/50
G66060	60# x 3/4" FIP	1/50
G66100	100# x 3/4" FIP	1/24
G67015	15# x 1" FIP	1/50
G67030	30# x 1" FIP	1/50
G67060	60# x 1" FIP	1/50
G67100	100# x 1" FIP	1/100
G66000	3/4" Bell body (less air valve)	1/100
G66002	3/4" Bell body (with air valve)	1/100
G67000	1" Bell body (less air valve)	1/59
G67002	1" Bell body (with air valve)	1/80

Gas Test Gauge Assembly



- 4" face and pressure snubber
- Regulates air to an even flow
- Over pressurization will void the warranty
- Protects the diaphragm from compressed air damage
- Class 1A gauge

PART NO.	DESCRIPTION	CTN/MSTR
G64155	5 lb. test gauge assembly	1/20
G65155	15 lb. test gauge assembly	1/20

Gas Test Gauge Assembly



- Steel case with 2" shatterproof face
- Adapts to 3/4" MPT
- Plated body with 3/4" FIP inlet
- Brass air valve
- Individually boxed

PART NO.	DESCRIPTION	CTN/MSTR
G64030	30 PSI	1/50
G64060	60 PSI	1/50
G64100	100 PSI	1/50
G64160	160 PSI	1/50
G64200	200 PSI	1/50
G64333	300 PSI	1/50
G64000	1/4" air valve and cap	50/500
G64001	Gas test body only	1/100
G64002	1/8" air valve and cap	500/1000
G64020	Gas test body and air valve assembly	1/100

Tridicator



- 0-55 PSI
- 70°F to 250°F temperature range
- Back mount

PART NO.	DESCRIPTION	CTN/MSTR
J40550	2 1/2" face angle 2 1/4" stem (1/4" NPT)	1/50
J40551	2 1/2" face angle 2 1/2" stem (1/4" NPT)	1/50
J40558	2 1/2" face angle 1" stem (1/4" NPT)	1/50
J40560	3 1/2" face angle 2 3/4" stem (1/2" NPT)	1/50

Dual Scale Boiler Gauge



- 0-75 PSI
- 1/4" MIP connection
- -60-320° F, 20-160° C
- Center back mount
- 3-1/2" face

PART NO.	DESCRIPTION	CTN/MSTR
J40575	Dual scale boiler gauge	1/100

Vacuum Gauge



- 1/4" brass lower connection
- -30 to 0 inch Hg
- Black steel case with bronze internals
- 2" face

PART NO.	DESCRIPTION	CTN/MSTR
G63001	Vacuum gauge	1/100

Pressure Snubber



- Bronze body and core
- Use on lines with noticeable pressure changes/oscillations
- 1000 PSI maximum

PART NO.	DESCRIPTION	CTN/MSTR
G64300	1/4" NPT for air or gas	1/500
G64301	1/4" NPT for oil, steam or water	1/200

Needle Valve for Pressure Gauge



- Brass body, seat, stem and handle
- 1/4" NPT
- 300°F maximum temperature
- Female x female
- Teflon packing
- 2000 PSI

PART NO.	DESCRIPTION	CTN/MSTR
G64004	1/4" needle valve	1/125

Hot Water/Refrigerant Line Thermometer

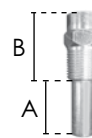

- Straight or angle pattern
- Steel or brass well included
- 40°-280°F x 5°F (5-120°C x 2°C)
- 1/2" NPT; 1" stem

PART NO.	DESCRIPTION	DIM (A)	DIM (B)	CTN/MSTR
J40500	Straight pattern with steel well	1"	1/2" NPT	1/50
J40501	Straight pattern with brass well	1"	1/2" NPT	1/50
J40502	Angle pattern with steel well	1"	1/2" NPT	1/50
J40503	Angle pattern with brass well	1"	1/2" NPT	1/50

Dial Thermometer



- 2-1/2" face
- 5° increments
- Dual scale: 40°-240°/0°-120°C
- Brass wells/removable thermometers
- Thermometers are not supplied with wells

PART NO.	DESCRIPTION	CTN/MSTR
J40702	3/4" SWT connection	1/50
J40703	1/2" MIP connection	1/100
J40704	3/4" SWT well	1/100
J40705	1/2" MIP well	1/100

Weksler Industrial Multi-Angle Thermometer

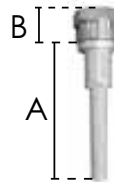

- Must have well - no well provided; order wells separately
- 9" scale, red-reading mercury tubes
- Molded cyclocac case with glass window
- Adjustable to any angle
- Accurate to +/- one scale division
- Must have well

PART NO.	DESCRIPTION	DIM (A)	DIM (B)	CTN/MSTR
J40505	Hot water 30°-240°F	3-1/2" stem	1" NPSM	1/50
J40506	Cold water 0°-120°F	3-1/2" stem	1" NPSM	1/25
J40510	Standard brass well	2-1/2" stem	3/4" NPT	1/100
J40511	Extended well	1-3/4" stem	3/4" NPT	1/100

Items marked with the Jones Stephens logo are "You Need It... We Got It" Items.

Bi-Metal Dial Thermometer

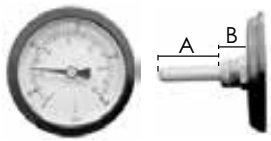

- For commercial or home heating systems
- 1/2" NPT
- 20°-240°F temperature range
- 3" dial in steel case
- Angle has back connection; straight has bottom connection

PART NO.	DESCRIPTION	DIM (A)	DIM (B)	CTN/MSTR
J40561	Angle outlet with brass well	2-3/8" stem	1/2" NPT	1/50
J40562	Straight outlet with brass well	2-3/8" stem	1/2" NPT	1/50



- Solid brass construction
- 1-1/2" stem
- 1/2" MPT x 1/4" FPT threads

PART NO.	DESCRIPTION	CTN/MSTR
J40563	Brass well for J40562	1/200

Pocket Test Thermometer



- 2% accuracy for hot and cold
- Pocket clip on sheath; 5" stem

PART NO.	DESCRIPTION	CTN/MSTR
J40700	Cold thermometer (-40° to 160°F)	1/80
J40701	Hot thermometer (0° to 220°F)	1/80

Natural Polyethylene Tubing



- Non-toxic, 100% virgin material
- 100' coil in dispenser box
- FDA grade
- -40°F to +135°F
- Low density

PART NO.	OD	ID	PSI	WALL	FT/BOX	CTN/MSTR
T25250	1/4"	.170"	120	.040	100'	1/1
T25312	5/16"	.187"	150	.040	100'	1/1
T25375	3/8"	.250"	125	.062	100'	1/1
T25500	1/2"	.375"	95	.062	100'	1/1
T25625	5/8"	.500"	75	.500	100'	1/1

Clear Vinyl Tubing



- 75 duro clear
- 100' coil in dispenser box
- -5°F to +125°F
- Self-dispensing cartons
- FDA grade

PART NO.	OD	ID	WALL	WPPSI	FT/BOX	CTN/MSTR
T26124	3/16"	1/8"	1/32"	50	100'	1/1
T26125	1/4"	1/8"	1/16"	80	100'	1/1
T26186	1/4"	3/16"	1/32"	40	100'	1/1
T26187	5/16"	3/16"	1/16"	60	100'	1/1
T26250	3/8"	1/4"	1/16"	55	100'	1/1
T26252	1/2"	1/4"	1/8"	90	100'	1/1
T26312	7/16"	5/16"	1/16"	50	100'	1/1
T26313	1/2"	5/16"	3/32"	60	100'	1/1
T26375	1/2"	3/8"	1/16"	45	100'	1/1
T26376	9/16"	3/8"	3/32"	55	100'	1/1
T26377	5/8"	3/8"	1/8"	65	100'	1/1
T26498	5/8"	1/2"	1/16"	30	100'	1/1
T26500	3/4"	1/2"	1/8"	45	100'	1/1
T26626	3/4"	5/8"	1/16"	30	100'	1/1
T26625	7/8"	5/8"	1/8"	40	100'	1/1
T26750	1"	3/4"	1/8"	35	100'	1/1
T26875	1 1/8"	7/8"	1/8"	30	50'	1/1
T26000	1 1/4"	1"	1/8"	28	50'	1/1

Soft Aluminum Tubing



- 50' coils
- Alloy 3003-0, ASTM B-483

PART NO.	OD	WALL	CTN/MSTR
T27125	1/8"	.025	1/10
T27188	3/16"	.028	1/10
T27250	1/4"	.032	1/10
T27313	5/16"	.035	1/10
T27375	3/8"	.035	1/10
T27438	7/16"	.035	1/10
T27500	1/2"	.035	1/10
T27625	5/8"	.035	1/10

Items marked with the Jones Stephens logo are "You Need It...We Got It" Items.

Stud Protectors and Plate



- Protects piping and wiring from nails
- CARTON QUANTITIES ONLY

MADE IN THE
USA

PART NO.	DESCRIPTION	GAUGE	CTN/MSTR
S33001	1-1/2" x 6"	18	100/100
S33002	1-1/2" x 3"	18	100/100
S33003	5" x 8" (not self nailed)	16	50/50
S33005	1-1/2" x 6"	16	100/100
S33006	1-1/2" x 5"	18	100/100
S33010	1-1/2" x 6"	22	100/100
S33011	1-1/2" x 3"	22	100/100
S33012	3-1/2" x 6" (not self nailed)	16	100/100

C

Interlocking Stud Guard



- CARTON QUANTITIES ONLY

MADE IN THE
USA

PART NO.	DESCRIPTION	GAUGE	CTN/MSTR
S33004	1-1/2" x 6"	20	100/100
S33007	1-1/2" x 6"	16	100/100
S33016	3-1/2" x 6"	16	25/25

Stud Shoe



- 18 gauge galvanized
- 4 nail holes on each side
- Pipe opening accommodates 2" IPS or smaller pipe
- Stud/joist reinforcement when drilling or notching for pipe runs
- CARTON QUANTITIES ONLY

MADE IN THE
USA

PART NO.	DESCRIPTION	CTN/MSTR
S33021	Single stud shoe	50/50
S33022	Double stud shoe	25/25
S33023	Triple stud shoe	10/10

Stud Guard



- 6 holes, 2 nailers
- Self-nailing
- Protects pipes
- CARTON QUANTITIES ONLY

MADE IN THE
USA

PART NO.	DESCRIPTION	GAUGE	CTN/MSTR
S33013	5" x 8" stud guard	16	25/25



- CARTON QUANTITIES ONLY

MADE IN THE
USA

PART NO.	DESCRIPTION	GAUGE	CTN/MSTR
S33318	3-1/2" x 18" stud guard	16	25/25



- 20 holes
- CARTON QUANTITIES ONLY

MADE IN THE
USA

PART NO.	DESCRIPTION	GAUGE	CTN/MSTR
S33518	5" x 18" stud guard	16	15/15

Stud Guard

MADE IN THE
USA



S180032



S16006



S163566

- CARTON QUANTITIES ONLY

Self Nailing Stud Guard with 2 Holes Centered

PART NO.	SIZE	GAUGE	CTN/MSTR
S180032	1-1/2" x 3"	18	200/200

2 Hole Stud Guard

PART NO.	SIZE	GAUGE	CTN/MSTR
S16006	1-1/2" x 6"	16	100/100

6 Hole Stud Guard

PART NO.	SIZE	GAUGE	CTN/MSTR
S163566	3-1/2" x 6"	16	25/25

Self Nailed Stud Guard

PART NO.	SIZE	GAUGE	CTN/MSTR
S16009	1-1/2" x 9"	16	100/100
S16012	1-1/2" x 12"	16	100/100
S16018	1-1/2" x 18"	16	50/50
S16024	1-1/2" x 24"	16	25/25
S20012	1-1/2" x 12"	20	100/100
S20009	1-1/2" x 9"	20	100/100
S16005	1-1/2" x 5"	16	100/100
S16003	1-1/2" x 3"	16	100/100

F.H.A. Strap - Galvanized Steel



- Tie plates
- CARTON QUANTITIES ONLY

MADE IN THE
USA

PART NO.	SIZE	GAUGE	CTN/MSTR
F12009	1-1/2" x 9"	12	50/50
F18009	1-1/2" x 9"	18	100/100
F12012	1-1/2" x 12"	12	50/50
F18012	1-1/2" x 12"	18	100/100
F12018	1-1/2" x 18"	12	50/50
F18018	1-1/2" x 18"	18	100/100
F12024	1-1/2" x 24"	12	50/50
F18024	1-1/2" x 24"	18	100/100

F.H.A. Strap



- CARTON QUANTITIES ONLY

MADE IN THE
USA

PART NO.	SIZE	GAUGE	CTN/MSTR
F18309	3" x 9"	18	50/50
F18312	3" x 12"	18	50/50
F18318	3" x 18"	18	50/50
F18324	3" x 24"	18	50/50

Items marked with the Jones Stephens logo are "You Need It...We Got It" Items.

F.H.A. Strap

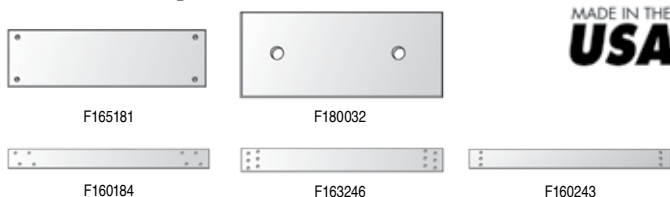

MADE IN THE
USA

• CARTON QUANTITIES ONLY

One Hole in Each Corner

PART NO.	SIZE	GAUGE	CTN/MSTR
F165181	5" x 18"	16	15/15

2 Holes

PART NO.	SIZE	GAUGE	CTN/MSTR
F180032	1-1/2" x 3"	18	200/200

3 Holes Vertically Aligned

PART NO.	SIZE	GAUGE	CTN/MSTR
F160123	1-1/2" x 12"	16	50/50
F160183	1-1/2" x 18"	16	50/50
F160243	1-1/2" x 24"	16	50/50
F160363	3" x 6"	16	50/50
F160393	3" x 9"	16	50/50
F160063	1-1/2" x 6"	16	50/50
F160093	1-1/2" x 9"	16	50/50

Standard F.H.A. with 4 Offset Holes

PART NO.	SIZE	GAUGE	CTN/MSTR
F14012	1-1/2" x 12"	14	50/50
F16012	1-1/2" x 12"	16	50/50
F160184	1-1/2" x 18"	16	50/50
F160094	1-1/2" x 9"	16	50/50

Standard F.H.A. with 6 Offset Holes

PART NO.	SIZE	GAUGE	CTN/MSTR
F160126	1-1/2" x 12"	16	50/50
F16016	1-1/2" x 16"	16	50/50
F160186	1-1/2" x 18"	16	50/50
F160246	1-1/2" x 24"	16	50/50
F163186	3" x 18"	16	50/50
F163246	3" x 24"	16	50/50
F165186	5" x 18"	16	15/15

Galvanized Bracket

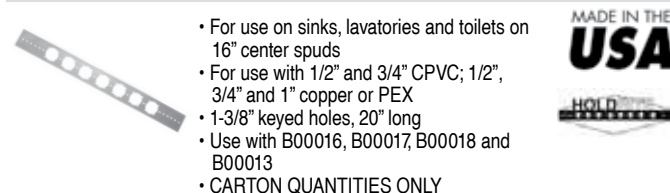

MADE IN THE
USA

- For use on sinks, lavatories and toilets on 16" center spuds
- For use with 1/2" and 3/4" CPVC; 1/2", 3/4" and 1" copper or PEX
- 1-3/8" keyed holes, 20" long
- Use with B00016, B00017, B00018 and B00013
- CARTON QUANTITIES ONLY

PART NO.	DESCRIPTION	HR #	CTN/MSTR
B00001	1/2" - 1" x 20"	103-18	50/50

Items marked with the Jones Stephens logo are "You Need It...We Got It" Items.

Flat Copper Plated Bracket

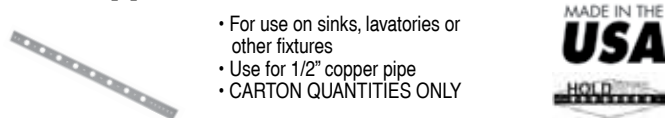

MADE IN THE
USA

- For use on sinks, lavatories or other fixtures
- Use for 1/2" copper pipe
- CARTON QUANTITIES ONLY

PART NO.	DESCRIPTION	HR #	CTN/MSTR
B00003	1/2" x 20"	101-18	50/50
B00021	1/2" x 26"	101-26	50/50

Flat Copper Plated Bracket

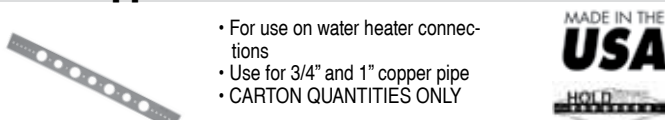

MADE IN THE
USA

- For use on water heater connections
- Use for 3/4" and 1" copper pipe
- CARTON QUANTITIES ONLY

PART NO.	DESCRIPTION	HR #	CTN/MSTR
B00004	3/4" - 1" x 20"	102-18	50/50

Flat Copper Plated Bracket

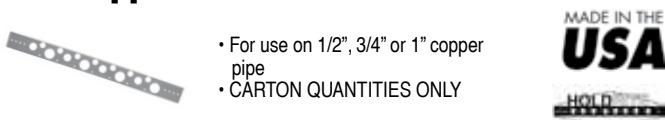

MADE IN THE
USA

- For use on 1/2", 3/4" or 1" copper pipe
- CARTON QUANTITIES ONLY

PART NO.	DESCRIPTION	HR #	CTN/MSTR
B00005	1/2" - 1" x 20"	107-18	50/50

Flat Copper Plated Bracket

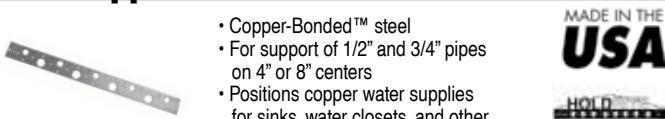

MADE IN THE
USA

- Copper-Bonded™ steel
- For support of 1/2" and 3/4" pipes on 4" or 8" centers
- Positions copper water supplies for sinks, water closets, and other fixtures
- 25 lb. load rating
- CARTON QUANTITIES ONLY

PART NO.	DESCRIPTION	HR #	CTN/MSTR
B00025	1/2" - 3/4" x 20"	150-20	50/50

Copper Plated Carrier Bracket

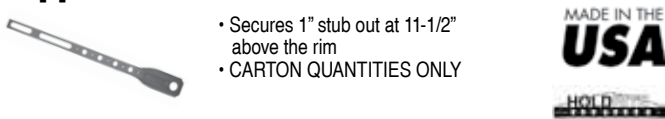

MADE IN THE
USA

- Secures 1" stub out at 11-1/2" above the rim
- CARTON QUANTITIES ONLY

PART NO.	DESCRIPTION	HR #	CTN/MSTR
B00022	Carrier bracket	114-C	6/6

Pipe Bracket

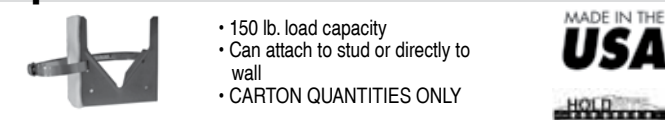

MADE IN THE
USA

- 150 lb. load capacity
- Can attach to stud or directly to wall
- CARTON QUANTITIES ONLY

PART NO.	DESCRIPTION	HR #	CTN/MSTR
B00024	Pipe bracket	V2	25/25

Extruded Hole Copper Plated Bracket



- For use on 1/2", 3/4" or 1" copper pipe
- Extruded holes
- CARTON QUANTITIES ONLY



PART NO.	DESCRIPTION	HR #	CTN/MSTR
B00006	1/2" - 1" x 20"	108-20	50/50
B00019	1/2" - 1" x 26"	108-26	50/50

Extruded Notches Copper Plated Bracket



- For use on 1/2", 3/4" or 1" copper pipe
- Extruded holes
- CARTON QUANTITIES ONLY



PART NO.	DESCRIPTION	HR #	CTN/MSTR
B00007	1/2" - 3/4" x 20"	140	50/50

Galvanized Lockright Pipe Bracket for CPVC



- For use on sinks or lavatories using CPVC
- 20 gauge galvanized steel with 1" holes on 2" centers
- Use with B00014 and B00015
- CARTON QUANTITIES ONLY



PART NO.	DESCRIPTION	HR #	CTN/MSTR
B00008	1/2" - 3/4" x 20"	601-20	50/50

Galvanized Lockright Bracket



- CARTON QUANTITIES ONLY



PART NO.	DESCRIPTION	HR #	CTN/MSTR
B00020	1/2" - 3/4" x 26"	601-26	50/50

Copper Plated Bracket for Water Closet



- For use on 1/2" copper pipe
- For use with water closets or hose bibbs
- CARTON QUANTITIES ONLY



PART NO.	DESCRIPTION	HR #	CTN/MSTR
B00002	1/2"	109-N-6	50/50

Galvanized L Bracket for PEX



- For use with PEX on overhead and side runs
- Use with B00013, B00016, B00017 and B00018 inserts
- CARTON QUANTITIES ONLY



PART NO.	DESCRIPTION	HR #	CTN/MSTR
B00009	Bracket with 1 3/8" keyed holes-PEX	709L	50/50

Turnout Bend Support for PEX



- PEX turnout bend support for potable water installations
- CARTON QUANTITIES ONLY



PART NO.	DESCRIPTION	HR #	CTN/MSTR
B00013	3/8" - 1/2"	704	25/100

Insert for CPVC



- Fire retardant plastic
- CARTON QUANTITIES ONLY



PART NO.	DESCRIPTION	HR #	CTN/MSTR
B00014	1/2" insert	604	100/100

Metal Stud Insulator



- Fire retardant plastic
- Use for copper pipe
- CARTON QUANTITIES ONLY



PART NO.	DESCRIPTION	HR #	CTN/MSTR
B00016	1/2" insulator	404-R	100/100
B00017	3/4" insulator	405-R	100/100
B00018	1" insulator	406-R	100/100

Schedule 40 Pipe Hanger



- Alternating screw and nail holes
- Load rating 250# max

PART NO.	DESCRIPTION	CTN/MSTR
H30001	1-1/2" galvanized pipe hanger	1/50
H30002	2" galvanized pipe hanger	1/50
H30003	3" galvanized pipe hanger	1/50
H30004	4" galvanized pipe hanger	1/50
H30011	1-1/2" vinyl coated pipe hanger	1/100
H30022	2" vinyl coated pipe hanger	1/50
H30033	3" vinyl coated pipe hanger	1/50
H30044	4" vinyl coated pipe hanger	1/50

Plastic Coated Pipe Hook



- Steel pipe hook with plastic insulation
- Coated black

MADE IN THE USA

PART NO.	DESCRIPTION	CTN/MSTR
H12054	1/2" x 4" pipe hook	50/1000
H12056	1/2" x 6" pipe hook	50/1000
H12074	3/4" x 4" pipe hook	50/1000
H12076	3/4" x 6" pipe hook	50/1000
H12106	1" x 6" pipe hook	50/1000

"Copper Boy" Pipe Hook



- CARTON QUANTITIES ONLY

MADE IN THE USA

PART NO.	DESCRIPTION	CTN/MSTR
H10052	1/2" x 2-1/2" copper clad pipe hook	50/2200
H10072	3/4" x 2-1/2" copper clad pipe hook	50/500

Drive J-Hook



- Copper clad
- CARTON QUANTITIES ONLY

MADE IN THE USA

PART NO.	DESCRIPTION	CTN/MSTR
H23050	1/2" x 3/4" CTS drive j-hook	100/100

Pipe Hook



Plain Steel



Copper Clad

- 10 gauge
- CARTON QUANTITIES ONLY

MADE IN THE USA

PART NO.	SIZE	MATERIAL	CTN/MSTR
H10054	1/2" x 4"	Plain Steel	50/500
H10056	1/2" x 6"	Plain Steel	50/500
H10058	1/2" x 8"	Plain Steel	50/500
H10074	3/4" x 4"	Plain Steel	50/500
H10076	3/4" x 6"	Plain Steel	50/500
H10078	3/4" x 8"	Plain Steel	50/500
H10080	3/4" x 10"	Plain Steel	50/500
H10106	1" x 6"	Plain Steel	50/500
H10108	1" x 8"	Plain Steel	50/500
H10110	1" x 10"	Plain Steel	50/500
H10126	1-1/4" x 6"	Plain Steel	50/500
H10128	1-1/4" x 8"	Plain Steel	50/500
H10156	1-1/2" x 6"	Plain Steel	50/500
H10158	1-1/2" x 8"	Plain Steel	50/500
H10208	2" x 8"	Plain Steel	50/500
H11054	1/2" x 4"	Copper Clad	50/500
H11056	1/2" x 6"	Copper Clad	50/500
H11058	1/2" x 8"	Copper Clad	50/500
H11074	3/4" x 4"	Copper Clad	50/500
H11076	3/4" x 6"	Copper Clad	50/500
H11078	3/4" x 8"	Copper Clad	50/500
H11080	3/4" x 10"	Copper Clad	50/500
H11106	1" x 6"	Copper Clad	50/500
H11108	1" x 8"	Copper Clad	50/500
H11126	1-1/4" x 6"	Copper Clad	50/500
H11156	1-1/2" x 6"	Copper Clad	50/500
H11208	2" x 8"	Copper Clad	50/500
H11210	2" x 10"	Copper Clad	50/500

C

J-Hook for CTS Water System



- Fabricated of durable ABS plastic
- Nail holes on all four sides - nails are included!
- No heat distortion even at 250°
- Eliminates corrosion and electrolysis on copper pipe
- FULL BAG QUANTITIES ONLY

Baby J-Hooks

PART NO.	DESCRIPTION	BAG/CTN QTY
J01050	1/2" CTS x 4" length	25/300
J01075	3/4" CTS x 4" length	25/300
J01100	1" CTS x 4" length	25/200

Long Baby J-Hooks

PART NO.	DESCRIPTION	BAG/CTN QTY
J01057	1/2" CTS x 7-1/2" length	25/200
J01077	3/4" CTS x 7-1/2" length	25/200

J-Hook for Drain Pipe System



- Fabricated of durable ABS plastic
- Nails included
- Reduces installation time
- Glueable with universal cement
- Designed for PVC and ABS pipe
- Calibrated for 1/8" fall per foot - no more measuring & adjusting for fall
- UPC listed
- FULL BAG QUANTITIES ONLY



PART NO.	DESCRIPTION	BAG/CTN QTY
J01150	1-1/2" DWV x 7" length	25/300
J01200	2" DWV x 7" length	25/300
J01300	3" DWV x 7" length	25/300
J01400	4" DWV x 7" length	25/300

Pipe Strap



- Priced each
- CARTON QUANTITIES ONLY



PART NO.	SIZE	MATERIAL	# HOLES	CTN/MSTR
H13038	3/8" IPS	Galvanized	2	200/200
H13050	1/2" IPS	Galvanized	2	150/150
H13075	3/4" IPS	Galvanized	2	50/50
H13100	1" IPS	Galvanized	2	50/50
H13125	1-1/4" IPS	Galvanized	2	50/50
H13150	1-1/2" IPS	Galvanized	2	25/25
H13200	2" IPS	Galvanized	2	25/25
H13250	2-1/2" IPS	Galvanized	2	25/25
H13300	3" IPS	Galvanized	2	10/10
H13400	4" IPS	Galvanized	2	10/10
H15050	1/2" CTS	Copper Clad	2	100/100
H15075	3/4" CTS	Copper Clad	2	100/100
H15100	1" CTS	Copper Clad	2	100/100
H15125	1-1/4" CTS	Copper Clad	2	100/100
H15150	1-1/2" CTS	Copper Clad	2	100/100
H15200	2" CTS	Copper Clad	2	100/100
H16038	3/8" CTS	Solid Copper	2	100/100
H16050	1/2" CTS	Solid Copper	2	100/100
H16075	3/4" CTS	Solid Copper	2	100/100
H16100	1" CTS	Solid Copper	2	100/100
H18050	1/2" IPS	Galvanized	1	100/100
H18075	3/4" IPS	Galvanized	1	100/100

Copper Clad Nail



- CARTON QUANTITIES ONLY



PART NO.	DESCRIPTION	CTN/MSTR
H15001	1-1/4" copper clad nail	200/2000

Copper Coated J-Nails



- CARTON QUANTITIES ONLY



PART NO.	DESCRIPTION	CTN/MSTR
H22050	1/2" copper coated j-nail	100/1300
H22075	3/4" copper coated j-nail	100/1300

Full Clamp



- Plastic clamp with preloaded nail for copper, CPVC, polybutylene tubing
- CARTON QUANTITIES ONLY

PART NO.	TUBING SIZE	CTN/MSTR
H25050	1/2"	100/4000
H25075	3/4"	50/2000
H25100	1"	25/1025

Half Clamp



- Plastic clamp with preloaded nail for copper, CPVC, polybutylene tubing
- CARTON QUANTITIES ONLY

PART NO.	TUBING SIZE	CTN/MSTR
H24038	3/8"	100/7500
H24050	1/2"	50/1000
H24075	3/4"	50/1000
H24100	1"	50/2000

Insulating/Suspension Clamp



- Plastic insulating and suspension clamp in one
- Eliminates noise from tubing expansion and contraction
- For copper, CPVC and polybutylene tubing
- CARTON QUANTITIES ONLY

PART NO.	TUBING SIZE	CTN/MSTR
H26050	1/2"	50/1000
H26075	3/4"	50/1000
H26100	1"	50/600
H26125	1 1/4"	50/500
H26150	1 1/2"	25/500
H26200	2"	25/350

Pipe Insulator



- Plastic insulator eliminates noise from expansion and contraction
- For copper, CPVC and polybutylene tubing
- Drill hole size 1 3/8"
- UPC listed
- CARTON QUANTITIES ONLY



PART NO.	TUBING SIZE	CTN/MSTR
H27050	1/2"	25/1000
H27075	3/4"	25/1000
H27100	1"	25/1000

Items marked with the Jones Stephens logo are "You Need It... We Got It" Items.

2-Hole Pipe Clamp



- Plastic clamp eliminates noise from tubing expansion and contraction
- Supports copper, CPVC and polybutylene tubing
- CARTON QUANTITIES ONLY

PART NO.	TUBING SIZE	CTN/MSTR
H28050	1/2"	100/1000
H28075	3/4"	100/1000
H28100	1"	50/500
H28125	1 1/4"	50/750
H28150	1 1/2"	25/500
H28200	2"	25/250

F.H.A. Tub Hanger



- 12 gauge galvanized steel
- Adjustable on stud
- CARTON QUANTITIES ONLY

PART NO.	DESCRIPTION	CTN QTY
T12001	Tub Hanger	100

Metal Stud Pipe Insulator



- CARTON QUANTITIES ONLY

PART NO.	DESCRIPTION	CTN/MSTR
H29000	3/8", 1/2", 3/4"	50/500
H29010	1"	50/500

Earthquake Strap



- Holes are spread 1" apart on center

PART NO.	SIZE	GAUGE	CTN/MSTR
H20500	2" x 10'	22	1/10

Perforated Hanger Iron



- Alternating holes (bolt and nail)
- CARTON QUANTITIES ONLY

PART NO.	DESCRIPTION	GAUGE	CTN/MSTR
H20001	3/4" x 10' galvanized	20 (heavy)	50/50
H20002	3/4" x 10' galvanized	24 (medium)	50/50
H20003	3/4" x 10' galvanized	28 (light)	50/50
H20005	3/4" x 50' galvanized	20 (heavy)	10/10
H20006	3/4" x 50' galvanized	24 (medium)	10/10
H20007	3/4" x 50' galvanized	28 (light)	10/10
H20010	3/4" x 100' galvanized	20 (heavy)	5/5
H20011	3/4" x 100' galvanized	24 (medium)	10/10
H20012	3/4" x 100' galvanized	28 (light)	10/10
H20100	3/4" x 10' copper clad	22 (heavy)	50/50
H20150	3/4" x 50' copper clad	22 (heavy)	10/10

Items marked with the Jones Stephens logo are "You Need It...We Got It" Items.

Plastic Hanger Tape



- Flexible, non-conductive polypropylene
- 3/4" wide, .050 thick
- 1/8" diameter holes every 3/4"
- 125 lb. ultimate load ASTM A-370-77
- Can be cut with scissors or utility knife
- Uses: pipe hanger, duct hanger and tubing utility strapping

MADE IN THE USA

PART NO.	DESCRIPTION	CTN/MSTR
H21010	10' roll poly bagged	1/200
H21025	25' roll poly bagged	1/50
H21050	50' roll poly bagged	1/20
H21100	100' roll poly bagged	1/30
H21101	100' roll dispenser box	1/25

Plastic Hanger Tape



- 125# max load
- 1/8" diameter holes every 3/4"
- 2" wide; .05 thickness; cuts with scissors

MADE IN THE USA

PART NO.	DESCRIPTION	CTN/MSTR
H21200	2" x 100' hanger tape	1/5

Nylon Line Reel



- Twisted nylon
- Carded

PART NO.	DESCRIPTION	CTN/MSTR
J40125	#18 x 270' nylon line reel	6/36

Mason's Nylon Twine



- Twisted yellow twine
- Approximately 165 lb. break strength

PART NO.	DESCRIPTION	CTN/MSTR
T60001	#18 x 225' nylon twine	24/192
T60000	#18 x 1100' nylon twine	12/72

10 lb. Tying Twine with Dispenser Box



- 650/1
- 10 lbs.
- Includes dispenser box

PART NO.	DESCRIPTION	CTN/MSTR
T60004	10 lb. dispenser	1/1

Candle Wick Packing



- Medium packing in 2 ounce balls

PART NO.	DESCRIPTION	CTN/MSTR
T60003	Candle wick packing	12/396

Graphite Packing



- Non-asbestos material in resealable spoos
- Up to 150°F

PART NO.	DESCRIPTION	CTN/MSTR
T60005	1/8" diameter x 12' spool	12/120
T60006	1/4" diameter x 8' spool	12/120

Oakum

C



- The original Oakum with benonite-expands over 10 times when wet
- Baled in coils or cut length for easy use
- No tar in brown oakum
- CARTON QUANTITIES ONLY (except 1 lb. bags)

PART NO.	DESCRIPTION	INNER PACK	CTN/MSTR
O15001	Brown random cut	10 - 5 lb. bags	10/10
O15002	White 3/8" cord	6 - 10 lb. coils	6/10
O15003	White 3/8" cord (27" cut length)	10 - 5 lb. bags	10/10
O15006	Brown random cut	1 lb. bags	1/20
O15007	White 3/8" cord (27" cut length)	1 lb. bags	1/20

Lead Wool



- Five pound box

PART NO.	DESCRIPTION	CTN/MSTR
L40001	5 lbs. lead wool	1/10

Lead Ingot



L42002



L42052

PART NO.	DESCRIPTION	CTN/MSTR
L40002	25 lbs. (Handle with four 5 lb. plugs)	1/1
L42052	5 lbs.	1/1

Lead Melting Pot



- Wire handle

PART NO.	DESCRIPTION	CTN/MSTR
L42006	6" depth pot	1/1
L42008	8" depth pot	1/1

Lead Pouring Ladle



- Wrought steel

PART NO.	DESCRIPTION	CTN/MSTR
L42102	3" ladle	1/100
L42103	3-1/2" ladle	1/50
L42104	4" ladle	1/50

Drum Trap Cover



- Flanged, plated die cast
- Cover supplied with gasket
- D02002 - CARTON QUANTITIES ONLY

PART NO.	DESCRIPTION	CTN/MSTR
D02001	Cover and gasket	25/100
D02002	Gasket only	25/100
P55300	Rough brass cover	1/60

Trap Covers



C98001



C98002

- Stainless steel

PART NO.	DESCRIPTION	CTN/MSTR
C98001	5-3/4" flat SS trap cover	150/300
C98002	5-3/4" raised SS trap cover	50/200

Wet-R-Dri Roofing Cement



- All-weather plastic
- Chemically fortified to bond to water-covered, damp or dry surfaces
- Great for emergency repairs under wet conditions

PART NO.	DESCRIPTION	CTN/MSTR
C09000	5 gallon can	1/1
C09001	1 gallon can	1/6
C09002	10.5 ounce cartridge	1/12

Foundation and Roof Coating



- Non-fibered liquid damp-proof seal
- All weather plastic
- Chemically fortified to bond to water covered, damp or dry surfaces
- Great for emergency repairs under wet conditions

PART NO.	DESCRIPTION	CTN/MSTR
C09003	1 gallon can	1/6

Sewage Ejector/Sump Pump Check Valve



- Couplings are sized for IPS ID hose
- Combination unit for 1-1/2" and 1-1/4" IPS, 1-1/2" copper

PART NO.	DESCRIPTION	CTN/MSTR
C29150	1-1/2" slip x 1-1/2" slip	1/50
C29200	2" slip x 2" slip	1/50
C29126	1-1/4" slip x 1-1/2" slip	1/50

Flexible Discharge Hose



- Ideal for sump pumps, centrifugal pumps, and submersible pumps
- Kits include 24' hose, threaded adapter and steel clamp

PART NO.	DESCRIPTION	CTN/MSTR
C29123	1-1/2" flex discharge hose kit	1/5
C29124	1-1/4" flex discharge hose kit	1/5

Roofite® Hi-Heat Silicone Flashing



- Silicone range is designed for high temperature applications up to 390°F
- Ideal for corrugated metal roofs
- Can be used on flat roofs
- Pipe diameter markings
- For plumbing, heating, air conditioning, electrical or exhaust vents
- Pleated cone adjusts to any pitch up to 45° F
- Ozone and UV resistant

PART NO.	DESCRIPTION	CTN/MSTR
R16100	0" - 2-3/4"	1/25
R16101	2" - 6-1/8"	1/20
R16107	6" - 10-1/32"	1/10
R16108	9-1/2" - 14-3/4"	1/10

Roofite® Roof Flashing



- Made of EPDM with flexible aluminum base
- -30°F to +250°F
- Ideal for corrugated metal roofs
- Can be used on flat roofs
- Pipe diameter markings
- For plumbing, heating, air conditioning, electrical or exhaust vents
- Pleated cone adjusts to any pitch
- Ozone and UV resistant

PART NO.	DESCRIPTION	CTN/MSTR
R15109	0" - 1-1/4"	1/20
R15100	0" - 2-3/4" pipe	1/20
R15101	2" - 6-1/8" pipe	1/20
R15107	6" - 10-1/32" pipe	1/10
R15108	9-1/2" - 14-3/4" pipe	1/10

Galvanized Roof Flashing



- Double seal neoprene collar
- UPC listed, BOCA and SBCCI approved



PART NO.	DESCRIPTION	FLANGE	CTN/MSTR
R40150	1-1/4" and 1-1/2"	8-3/4" x 12-1/2"	1/12
R40200	2"	8-3/4" x 12-1/2"	1/12
R40300	3"	10-3/4" x 14-1/2"	1/12
R40400	4"	12" x 16"	1/12

Aluminum Roof Flashing



- Double seal neoprene collar



PART NO.	DESCRIPTION	FLANGE	CTN/MSTR
R45150	1-1/4" and 1-1/2"	8-3/4" x 12-1/2"	1/12
R45200	2"	8-3/4" x 12-1/2"	1/12
R45300	3"	10-3/4" x 14-1/2"	1/12
R45400	4"	12" x 16"	1/12

All Neoprene Roof Flashing



- Double seal neoprene collar



PART NO.	DESCRIPTION	FLANGE	CTN/MSTR
R50150	1-1/4" and 1-1/2"	9" x 11-3/8"	1/20
R50200	2"	9" x 11-3/8"	1/20
R50300	3"	10" x 13-1/4"	1/20
R50400	4"	12" x 14-3/4"	1/20

Neo-poly Roof Flashing



- Poly vinyl base
- Neoprene collar



PART NO.	DESCRIPTION	FLANGE	CTN/MSTR
R57150	1-1/4" and 1-1/2"	9-1/4" x 13"	1/12
R57200	2"	9-1/4" x 13"	1/12
R57300	3"	11-1/8" x 15"	1/12
R57400	4"	12" x 15-1/2"	1/12

Lead Roof Flashing



- Southeastern Code
- 2-1/2 pounds
- Multi-pitch from flat to 7/12"
- CARTON QUANTITIES ONLY



PART NO.	DESCRIPTION	FLANGE	CTN/MSTR
R70150	1-1/2"	8-1/2" x 10-1/2"	12/12
R70200	2"	8-1/2" x 10-1/2"	12/12
R70300	3"	10-1/2" x 11-1/2"	6/6
R70400	4"	10-1/2" x 11-1/4"	6/6

Instant Sealant



- Flame resistant
- Fills holes and cracks
- Deadens sound
- Insulates against air conditioning and heat loss
- Prevents passage of dirt, water and insects
- Both 12 and 24 oz. cans spray in any position
- UPS GROUND AND MOTOR FREIGHT ONLY
- CARTON QUANTITIES ONLY

MADE IN THE
USA

PART NO.	DESCRIPTION	CTN/MSTR
S30012	12 oz. cans	12/12
S30024	24 oz. cans	12/12

Hose and Hose Bracket for Service Sink



- Heavy duty 300 cloth-reinforced 5/8" rubber hose (2-1/2" long)
- 3/4" brass hose coupling at one end
- 5" x 3" stainless steel bracket with rubber grip

PART NO.	DESCRIPTION	CTN/MSTR
M05001	Hose with bracket	1/1
M05005	Bracket only	1/100

Mop Hanger for Service Sink



- 24" x 3" stainless steel hanger with three rubber tool grips
- Anchors included

PART NO.	DESCRIPTION	CTN/MSTR
M05003	Mop hanger	1/5

Stove Bolt with Nut



- Zinc plated
- CARTON QUANTITIES ONLY

PART NO.	SIZE	CTN/MSTR
F33009	3/16" x 3/4"	100/100
F33010	1/4" x 3/4"	100/100
F33011	1/4" x 1"	100/100
F33012	1/4" x 1-1/4"	100/100
F33013	1/4" x 1-1/2"	100/100
F33014	1/4" x 2"	100/100

Flat Phillips Head Brass Wood Screw



- Solid brass construction
- Flat Phillips head
- CARTON QUANTITIES ONLY

PART NO.	SIZE	CTN/MSTR
F33300	#12 x 1-1/4"	100/100
F33301	#12 x 1-1/2"	100/100
F33302	#12 x 2"	100/100
F33303	#14 x 1-1/4"	100/100

Phillips Head Wood Screw



- Zinc plated
- CARTON QUANTITIES ONLY

PART NO.	SIZE	CTN/MSTR
F33030	#10 x 1-1/2"	100/100
F33031	#12 x 1"	100/100
F33032	#12 x 1-1/4"	100/100
F33033	#12 x 1-1/2"	100/100
F33034	#12 x 2"	100/100
F33035	#12 x 2-1/2"	100/100
F33036	#12 x 3"	100/100
F33037	#14 x 1-1/4"	100/100
F33038	#14 x 1-1/2"	100/100
F33039	#14 x 2"	100/100
F33040	#14 x 2-1/2"	100/100
F33041	#14 x 3"	100/100

Hex Head Lag Screw



- CARTON QUANTITIES ONLY

PART NO.	SIZE	CTN/MSTR
F33140	3/8" x 1"	100/100
F33141	3/8" x 1-1/2"	100/100
F33142	3/8" x 2"	100/100
F33143	3/8" x 2-1/2"	50/50
F33144	3/8" x 3"	50/50

E-Z Anchor/Self-Drilling Wall Board



- Die cast zinc
- Installs with #2 Phillips screwdriver
- CARTON QUANTITIES ONLY

PART NO.	DESCRIPTION	CTN/MSTR
A33010	E-Z Anchor with 1-1/4" screws	10/10

Toggle Bolt



Toggle Bolt



Toggle Wing

- Zinc plated
- Spring loaded wing
- CARTON QUANTITIES ONLY

PART NO.	DESCRIPTION	CTN/MSTR
F33060	3/16" x 4" toggle bolt	50/50
F33061	1/4" x 3" toggle bolt only	50/50
F33062	1/4" x 4" toggle bolt only	50/50
F33063	1/4" x 6" toggle bolt only	50/50
F33064	3/8" x 4" toggle bolt only	50/50
F33065	3/8" x 6" toggle bolt only	50/50
F33066	3/16" toggle wing only	100/100
F33067	1/4" toggle wing only	100/100
F33068	3/8" toggle wing only	100/100
F33069	1/2" toggle wing only	100/100

Items marked with the Jones Stephens logo are "You Need It...We Got It" Items.

Hex Head Tapping Screw



- Zinc plated
- CARTON QUANTITIES ONLY

PART NO.	SIZE	CTN/MSTR
F33101	#7 x 1/2"	100/100
F33102	#7 x 1/2"	1000/1000
F33103	#8 x 1/2"	100/100
F33104	#8 x 1/2"	1000/1000
F33105	#8 x 3/4"	100/100
F33106	#8 x 3/4"	1000/1000
F33107	#8 x 1"	100/100
F33108	#8 x 1"	500/500
F33109	#8 x 1-1/2"	50/50
F33110	#8 x 1-1/2"	500/500
F33111	#8 x 2"	50/50
F33112	#8 x 2"	250/250
F33113	#10 x 3/4"	100/100
F33114	#10 x 3/4"	1000/1000
F33115	#10 x 1"	100/100
F33116	#10 x 1"	500/500

Drill Point Tech Screw



- CARTON QUANTITIES ONLY

PART NO.	SIZE	CTN/MSTR
F33120	#8 x 1/2"	100/100
F33121	#8 x 1/2"	500/500
F33122	#8 x 3/4"	100/100
F33123	#8 x 3/4"	500/500
F33124	#10 x 3/4"	100/100
F33125	#10 x 3/4"	500/500
F33126	#10 x 1"	100/100
F33127	#10 x 1"	500/500
F33128	#10 x 1-1/2"	100/100
F33129	#12 x 3/4"	100/100
F33130	#12 x 1"	100/100
F33131	#12 x 1-1/2"	100/100
F33132	#12 x 2"	100/100

Hex Nut



- Zinc plated
- CARTON QUANTITIES ONLY

PART NO.	SIZE	CTN/MSTR
F33080	1/4" - 20	100/100
F33081	5/16" - 18	100/100
F33082	3/8" - 16	100/100
F33083	1/2" - 13	50/50

Items marked with the Jones Stephens logo are "You Need It...We Got It" Items.

Anchor Bolt Kit



- Includes anchors, hex head screws and drill bit

PART NO.	SIZE	PIECES	DRILL BIT	CTN/MSTR
A33001	#8 x 1"	100	3/16"	1/50
A33002	#10 x 1-1/4"	100	1/4"	1/36
A33005	#14 x 1-1/2"	50	5/16"	1/36

Hollow Wall Anchor Kit



- 100 pieces
- 4 sizes and styles
- Anchors, screws and toggle bolts
- Reclosable, reusable, divided plastic container

PART NO.	DESCRIPTION	CTN/MSTR
A33006	100 piece hollow wall anchor kit	12/72

Fender Washer



- Zinc plated
- CARTON QUANTITIES ONLY

PART NO.	SIZE	OD	CTN/MSTR
F33098	1/4"	1-1/2"	100/100
F33096	3/8"	1-1/2"	100/100
F33097	1/2"	2"	100/100

Flat Washer



- Zinc plated
- CARTON QUANTITIES ONLY

PART NO.	SIZE	OD	CTN/MSTR
F33094	3/8"	1"	100/100
F33095	1/2"	1-3/8"	100/100

Carrier Nuts and Washer Set



- 4 aluminum nuts and plastic washers
- 5/8 - 11 threads
- Much lower cost than specification companies

PART NO.	DESCRIPTION	CTN/MSTR
C56100	Carrier nuts and washer set (4-pack)	1/100

Universal Beam Clamp



- 3/8" UNC bolt thread
- Steel set screw

PART NO.	SIZE	ROD SIZE	CTN/MSTR
H60375	3/8"	3/8"	1/25
H60050	1/2"	1/2"	1/25
H60625	5/8"	5/8"	1/25

Copper Pipe Hanger - Bell & Milford Types



• Copper clad

PART NO.	DESCRIPTION	CTN/MSTR
H83050 	1/2" bell type	25/500
H83075	3/4" bell type	25/500
H83100	1" bell type	25/500
H84050	1/2" x 6" milford type	1/25
H84075	3/4" x 6" milford type	1/25
H84100	1" x 6" milford type	1/25
H85050	1/2" x 12" milford type	1/25
H85075	3/4" x 12" milford type	1/25

Conduit Hanger



• Packed with bolts and nuts
• CARTON QUANTITIES ONLY

Zinc Plated				
PART NO.	CODE NO.	RIGID	THIN WALL	CTN/MSTR
H14050	0	1/2"-3/8"	1/2"	1/100
H14075	1	3/4"	3/4"	1/50
H14100	2	1"	1"	1/50
H14125	3	1-1/4"	-	1/50
H14150	4	1-1/2"	1-1/2"	1/25
H14200	5	2"	2"	1/25
H14250	6	2-1/2"	-	1/10
H14300	7	3"	-	1/10
H14400	9	4"	-	1/10

Copper Plated				
PART NO.	CODE NO.	RIGID	THIN WALL	CTN/MSTR
H17050	0	1/2"-3/8"	1/2"	1/100
H17075	1	3/4"	3/4"	1/100
H17100	2	1"	1"	1/50
H17125	3	1-1/4"	-	1/50
H17150	4	1-1/2"	1-1/2"	1/25
H17200	5	2"	2"	1/25
H17250	6	2-1/2"	-	1/25
H17300	7	3"	-	1/25
H17350	8	3-1/2"	-	1/25
H17400	9	4"	-	1/25

Swivel Ring



• Supplied with nuts

Zinc Plated			
PART NO.	SIZE	ROD SIZE	CTN/MSTR
H65050	1/2"	3/8"	1/25
H65075	3/4"	3/8"	1/25
H65100	1"	3/8"	1/25
H65125	1-1/4"	3/8"	1/25
H65150	1-1/2"	3/8"	1/25
H65200	2"	3/8"	1/20
H65250	2-1/2"	3/8"	1/20
H65300	3"	3/8"	1/10
H65400	4"	3/8"	1/10
H65500	5"	1/2"	1/5
H65600	6"	1/2"	1/5

Copper Plated			
PART NO.	SIZE	ROD SIZE	CTN/MSTR
H66050	1/2"	3/8"	1/25
H66075	3/4"	3/8"	1/25
H66100	1"	3/8"	1/25
H66125	1-1/4"	3/8"	1/25
H66150	1-1/2"	3/8"	1/25
H66200	2"	3/8"	1/20
H66250	2-1/2"	3/8"	1/20
H66300	3"	3/8"	1/10
H66400	4"	3/8"-	1/10

Zinc Plated Clevis Hanger



Standard - 401# Steel			
PART NO.	SIZE	ROD SIZE	CTN/MSTR
H68050	1/2"	3/8"	1/25
H68075	3/4"	3/8"	1/25
H68100	1"	3/8"	1/25
H68125	1-1/4"	3/8"	1/25
H68150	1-1/2"	3/8"	1/25
H68200	2"	3/8"	1/20
H68250	2-1/2"	1/2"	1/20
H68300	3"	1/2"	1/10
H68350	3-1/2"	1/2"	1/10
H68400	4"	5/8"	1/10
H68500	5"	5/8"	1/5
H68600	6"	3/4"	1/5
H68800	8"	7/8"	1/5

Light Duty - 400# Steel			
PART NO.	SIZE	ROD SIZE	CTN/MSTR
H69050	1/2"	3/8"	1/25
H69075	3/4"	3/8"	1/25
H69100	1"	3/8"	1/25
H69150	1-1/2"	3/8"	1/25
H69200	2"	3/8"	1/20
H69250	2-1/2"	1/2"	1/20
H69300	3"	1/2"	1/10
H69400	4"	5/8"	1/10

 Items marked with the Jones Stephens logo are "You Need It...We Got It" Items.

Riser Clamp



• For Schedule 40 iron pipe only - Not for soil pipe

PART NO.	SIZE	OVERALL WIDTH	CTN/MSTR
H70050	1/2"	9-3/8"	1/25
H70075	3/4"	9-3/8"	1/25
H70100	1"	9-3/8"	1/25
H70125	1-1/4"	10"	1/25
H70150	1-1/2"	10-3/8"	1/25
H70200	2"	10-7/8"	1/25
H70250	2-1/2"	11-1/4"	1/25
H70300	3"	11-3/4"	1/10
H70350	3-1/2"	13-1/4"	1/10
H70400	4"	13-1/2"	1/10

Hinged Split Ring



Zinc Plated for Iron Pipe

PART NO.	SIZE	ROD SIZE	CTN/MSTR
H72375	3/8"	3/8"	1/25
H72050	1/2"	3/8"	1/25
H72075	3/4"	3/8"	1/25
H72100	1"	3/8"	1/25
H72125	1-1/4"	3/8"	1/25
H72150	1-1/2"	3/8"	1/25
H72200	2"	3/8"	1/20
H72250	2-1/2"	1/2"	1/20
H72300	3"	1/2"	1/10
H72400	4"	1/2"	1/10

Copper Plated for Copper Tube

PART NO.	SIZE	ROD SIZE	CTN/MSTR
H73375	3/8"	3/8"	1/25
H73050	1/2"	3/8"	1/25
H73075	3/4"	3/8"	1/25
H73100	1"	3/8"	1/25
H73125	1-1/4"	3/8"	1/25
H73150	1-1/2"	3/8"	1/25
H73200	2"	3/8"	1/10

Ceiling Flange

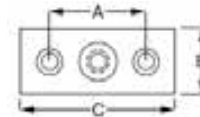

DIMENSIONS		
A	B	C
2"	1-3/8"	2-3/4"

PART NO.	SIZE	CTN/MSTR
H80375	3/8" plain finish (black)	1/25
H80050	1/2" plain finish (black)	1/25
H81375	3/8" zinc finish (galvanized)	1/25
H81050	1/2" zinc finish (galvanized)	1/25
H82375	3/8" copper finish	1/25
H82050	1/2" copper finish	1/25

Threaded Steel Rod



• Priced per rod
• CARTON QUANTITIES ONLY

PART NO.	DESCRIPTION	CTN/MSTR
T38006	3/8" x 6' plain finish (black)	1/25
T38010	3/8" x 10' plain finish (black)	1/25
T12006	1/2" x 6' plain finish (black)	1/12
T12010	1/2" x 10' plain finish (black)	1/12
T38106	3/8" x 6' zinc finish (galvanized)	1/25
T38110	3/8" x 10' zinc finish (galvanized)	1/25
T12106	1/2" x 6' zinc finish (galvanized)	1/12
T12110	1/2" x 10' zinc finish (galvanized)	1/12

Drop-In Concrete Anchor



• Priced per rod
• CARTON QUANTITIES ONLY

PART NO.	DESCRIPTION	CTN/MSTR
T38038	3/8" drop-in anchor	100/900
T12050	1/2" drop-in anchor	50/500

Rod Coupling Nut



• Hex, zinc plated, carbon steel

PART NO.	DESCRIPTION	CTN/MSTR
R60001	1/4" x 7/8" rod coupling nut	50/1000
R60002	3/8" x 1-3/4" rod coupling nut	50/1000
R60003	1/2" x 1-3/4" rod coupling nut	50/1000
R60004	5/8" x 2-1/8" rod coupling nut	50/200

Water Meter Box Keys and Covers



M07001



M07002



M25900



M25900 bottom view

PART NO.	DESCRIPTION	CTN/MSTR
M07001	Meter box key	1/100
M07002	Combination key and wrench	1/50
M25900	Penta head meter box and roadway box wrench	1/100

C

Water Meter Coupling Complete



- Heavy cast brass
- Complete with gasket
- Lead Free

PART NO.	SIZE	NPSM	LENGTH	NPT	CTN/MSTR
M20058	1/2"	3/4"	2-3/8"	1/2"	25/100
M20075	3/4"	1"	2-1/2"	3/4"	25/100
M20100	1"	1-1/4"	2-5/8"	1"	25/100

Gasket Only for Water Meter Couplings



- 3/32" thick
- CARTON QUANTITIES ONLY

PART NO.	DESCRIPTION	CTN/MSTR
M20581	5/8" gasket for coupling	25/25
M20751	3/4" gasket for coupling	25/25
M20101	1" gasket for coupling	25/25

10" Economy Plastic Water Meter Box



- Snap-in green lid
- 96 per pallet
- Drop in reader cover

PART NO.	DESCRIPTION	CTN/MSTR
M06001	10" rectangular box and green lid	1/96
M06002	10" green snap-in lid only	1/360

Note: All items shown are for non-vehicular applications. Concrete and asphalt installations are not recommended for plastic parts.

Items marked with the Jones Stephens logo are "You Need It...We Got It" Items.

12" Plastic Water Meter Box

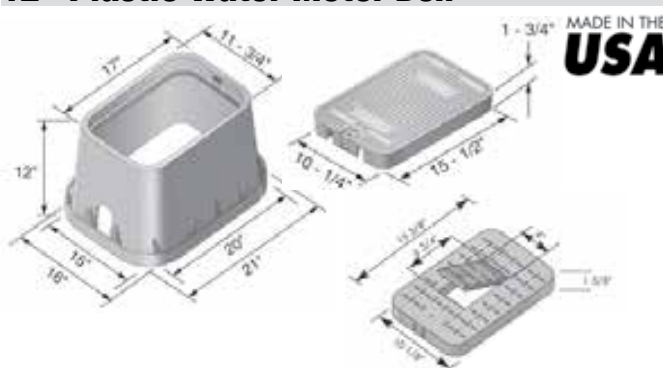

PART NO.	DESCRIPTION	CTN/MSTR
M12001	12" box and solid green lid	1/72
M12002	12" box and black reader lid	1/72
M12022	12" box and black lid marked "sewer"	1/72
M12003	6" extension	1/42
M12005	12" solid green lid only	1/216
M12006	12" black reader lid only	1/216
M12009	12" box and solid black lid	1/72

Note: All items shown are for non-vehicular applications. Concrete and asphalt installations are not recommended for plastic parts.

12" Plastic Water Meter Box with Solid Cast Iron Lid



- Drop in solid lid

PART NO.	DESCRIPTION	CTN/MSTR
M12100	12" box with black solid cast iron lid	1/72
M12085	Black cast iron lid only	1/230

Note: All items shown are for non-vehicular applications. Concrete and asphalt installations are not recommended for plastic parts.

12" Plastic Standard Water Meter Box with Plastic Lid and Cast Iron Reader



- 72 per pallet
- Drop in reader lid

PART NO.	DESCRIPTION	CTN/MSTR
M12004	12" box with plastic lid & black cast iron reader	1/72

Note: All items shown are for non-vehicular applications. Concrete and asphalt installations are not recommended for plastic parts.

12" Plastic Irrigation Box

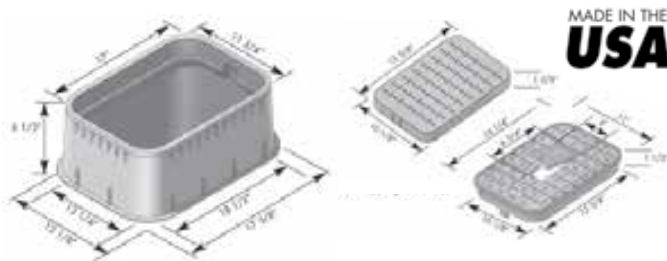

- 6" deep
- Drop in solid lid or overlapping reader lid available

PART NO.	DESCRIPTION	CTN/MSTR
M12007	12" box with green lid	1/1
M12005	12" solid green lid only	1/1
M12006	12" black reader lid only	1/1

Note: All items shown are for non-vehicular applications. Concrete and asphalt installations are not recommended for plastic parts.

15" Jumbo Water Meter Box

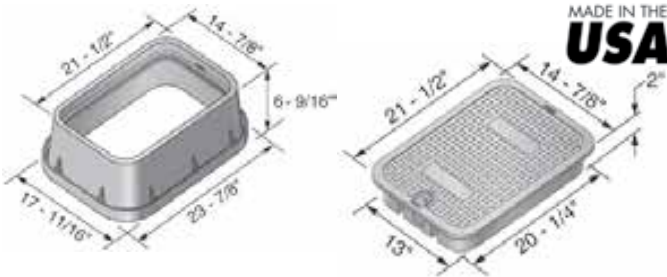

PART NO.	DESCRIPTION	CTN/MSTR
M15001	15" box and green solid lid	1/48
M15009	6" extension for M15001	1/36
M15002	15" box and black reader lid	1/48
M15005	15" black reader lid only	1/96

Note: All items shown are for non-vehicular applications. Concrete and asphalt installations are not recommended for plastic parts.

6" Residential Valve Box

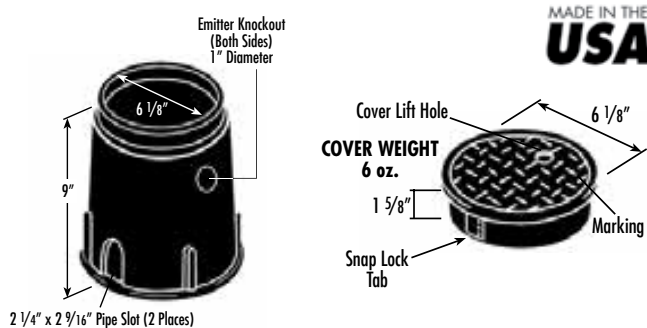

- 9" deep
- Snap-in green lid
- Overlapping cover keeps dirt or grass from between body and lid
- Valve box can be extended with any 6" plastic or iron pipe

PART NO.	DESCRIPTION	CTN/MSTR
M06006	6" valve box with green lid	1/36
M06007	6" green snap-in lid only	1/10

Note: All items shown are for non-vehicular applications. Concrete and asphalt installations are not recommended for plastic parts.

10" Round Valve Box

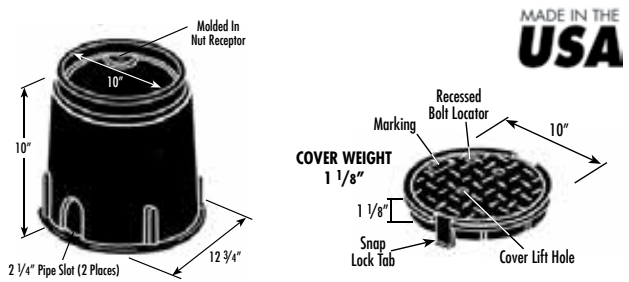

- Snap-in green lid
- Overlapping cover keeps dirt or grass from between body and lid
- 96 per pallet

PART NO.	DESCRIPTION	CTN/MSTR
M06010	10" round body and snap-in green lid	1/96

Note: All items shown are for non-vehicular applications. Concrete and asphalt installations are not recommended for plastic parts.

Shipping Boxes

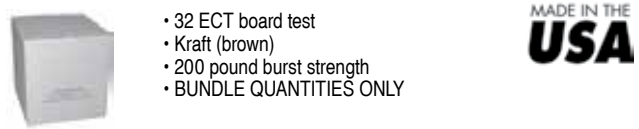

- 32 ECT board test
- Kraft (brown)
- 200 pound burst strength
- BUNDLE QUANTITIES ONLY

PART NO.	SIZE	CTN/MSTR
BOX011	11-1/8"L x 11-1/8"W x 9-1/8"D	1/20
BOX008	8"L x 8"W x 8"D	1/20
BOX006	6"L x 6"W x 8"D	1/20

Bin Boxes



PART NO.	SIZE	CTN/MSTR
BIN004	4-1/4"W x 12-1/2"L x 6-1/2"H	1/20
BIN005	5-1/2"W x 12"L x 6"H	1/20
BIN008	9"W x 12-1/2"L x 8"H	1/20
BIN012	12-3/4"W x 12-1/2"L x 9-1/4"H	1/20

Plastic Tub Box



PART NO.	SIZE	CTN/MSTR
T40001	13"L x 13"W x 7"D	1/100
T40002	12"L x 8-1/8"W x 6-1/2"D	1/150

Cardboard Tub Box



PART NO.	SIZE	CTN/MSTR
T40003	12"L x 8"W x 8-1/2"D wax coated	1/10
T40004	14-1/2"L x 11-5/16"W x 6"D wax coated	1/10
T40005	15"L x 12"W x 9"D non-coated	1/10
T40007	12"L x 12"W x 9"D non-coated	1/10
T40008	12"L x 12"W x 12"D non-coated	1/10

FITTINGS & VALVES

Brass Compression Fittings	135-136
Chrome Plated Compression Fittings	136
45° Flare Tube Fittings	137-138
Space Heater & Gas Range Fittings	139
Yellow Brass Pipe Fittings	140-141
PEX Fittings	142-144
Push On Fittings	145-147
Red Brass Pipe Fittings	148-149
Bronze Pipe Fittings	151
Chrome Plated Pipe Nipples & Fittings	152-153
Brass Garden Hose Fittings	154-155
Brass Hose Barbs	156
Nylon Fittings.....	157-158
Poly Insert Fittings.....	159
Red Brass Insert Fittings.....	160
Galvanized Insert Fittings.....	161
Brass Needle Valves	162
Shut-Off Valves	163
Drain Cocks/Air Cocks.....	164
Ball Valves	165-167
Radiator Accessories	167-168
Valves	168
Hose Bibbs	169
Gear Clamps	169-170
Flange Connection Gaskets & Kits	171-172
Rubber Sheet/Gasket Material	172
Water Hammer Arresters	173

*Published March 2017. List prices can be found in list price book and on our website.



Compression Cap

Style 61C



PART NO.	TUBE SIZE	CTN/MSTR
C74001LF	1/4"	500/1000
C74002LF	3/8"	500/1000
C74147LF	1/2"	1/1
C74155LF	5/8"	1/1

Compression Sleeve

Style 60



PART NO.	TUBE SIZE	CTN/MSTR
C74003	1/8"	10/2000
C74004	3/16"	10/2000
C74005	1/4"	10/2000
C74006	5/16"	10/2000
C74007	3/8"	5/2000
C74008	1/2"	5/2000
C74009	5/8"	5/2000
C74010	3/4"	5/1000
C74011	7/8"	3/1005

Compression Nut

Style 61



• CARTON QUANTITIES ONLY

PART NO.	TUBE SIZE	CTN/MSTR
C74012	1/8"	10/1000
C74013	3/16"	10/1000
C74014	1/4"	10/2000
C74015	5/16"	10/1000
C74016	3/8"	5/2000
C74152	7/16"	1/25
C74017	1/2"	5/1000
C74018	5/8"	5/1000
C74019	3/4"	5/400
C74020	7/8"	3/300

Delrin Compression Sleeve

Style 60P



• CARTON QUANTITIES ONLY

PART NO.	TUBE SIZE	CTN/MSTR
C74096	1/4"	100/100
C74097	3/8"	100/100
C74098	1/2"	100/100
C74099	5/8"	50/50

Compression Insert

Style 63P



• Lead Free

PART NO.	TUBE SIZE	CTN/MSTR
C74100LF	1/4"	100/2000
C74101LF	3/8"	100/2000
C74102LF	1/2"	10/2000
C74103LF	5/8"	10/2000

Compression Union

Style 62



• Lead Free

PART NO.	TUBE SIZE	CTN/MSTR
C74021LF	1/8"	10/300
C74022LF	3/16"	10/300
C74023LF	1/4"	10/500
C74025LF	3/8"	5/500
C74026LF	1/2"	100/400
C74027LF	5/8"	5/250
C74029LF	7/8"	3/102
C74030LF	3/8" x 1/4"	10/300
C74031LF	1/2" x 3/8"	5/300
C74032LF	5/8" x 3/8"	5/300
C74033LF	5/8" x 1/2"	5/300

Compression Tee

Style 64



• Lead Free

PART NO.	TUBE SIZE	CTN/MSTR
C74034LF	1/4"	10/300
C74036LF	3/8"	5/300
C74037LF	3/8" x 3/8" x 1/4"	10/300
C74038LF	1/2"	50/200
C74039LF	5/8"	5/200

Compression x FIP Branch Tee

Style 78



• Lead Free

PART NO.	TUBE x FIP	CTN/MSTR
C74091LF	3/8" x 1/8"	1/1

Compression x Sweat Adapter

Style 666



• Lead Free

PART NO.	TUBE x OD	CTN/MSTR
C74093LF	3/8" x 5/8" (1/2" swt)	5/200

Compression x FIP Connector

Style 66



• Lead Free

PART NO.	TUBE x FIP	CTN/MSTR
C74045LF	1/4" x 1/8"	10/200
C74046LF	1/4" x 1/4"	10/200
C74113LF	1/4" x 3/8"	10/200
C74114LF	1/4" x 1/2"	10/200
C74048LF	3/8" x 1/8"	200/800
C74049LF	3/8" x 1/4"	10/200
C74050LF	3/8" x 3/8"	5/200
C74051LF	3/8" x 1/2"	5/200
C74052LF	1/2" x 3/8"	100/400
C74053LF	1/2" x 1/2"	100/400
C74054LF	5/8" x 1/2"	5/200
C74118LF	5/8" x 3/4"	3/201
C74055LF	7/8" x 3/4"	3/201

Compression x MIP Connector

Style 68



• Lead Free

PART NO.	TUBE x MIP	CTN/MSTR
C74121LF	1/8" x 1/8"	10/200
C74058LF	1/4" x 1/8"	10/200
C74059LF	1/4" x 1/4"	250/1000
C74060LF	1/4" x 3/8"	10/200
C74123LF	1/4" x 1/2"	10/200
C74063LF	3/8" x 1/8"	10/200
C74064LF	3/8" x 1/4"	10/200
C74065LF	3/8" x 3/8"	5/200
C74066LF	3/8" x 1/2"	5/200
C74067LF	3/8" x 3/4"	3/201
C74068LF	1/2" x 1/4"	5/200
C74069LF	1/2" x 3/8"	5/200
C74070LF	1/2" x 1/2"	5/200
C74146LF	5/8" x 3/8"	5/200
C74071LF	5/8" x 1/2"	5/200
C74072LF	5/8" x 3/4"	3/201
C74149LF	7/8" x 1/2"	3/120
C74073LF	7/8" x 3/4"	3/201

Compression Elbow

Style 65



• Lead Free

PART NO.	TUBE SIZE	CTN/MSTR
C74040LF	1/4"	10/300
C74041LF	3/8"	5/300
C74042LF	1/2"	5/200
C74043LF	5/8"	5/200
C74044LF	5/8" x 3/8"	100/200
C74112LF	7/8"	50/100

Compression x FIP Elbow

Style 70



• Lead Free

PART NO.	TUBE x FIP	CTN/MSTR
C74078LF	3/8" x 1/2"	5/200
C74131LF	1/2" x 3/8"	5/200

Compression x MIP Elbow

Style 69



• Lead Free

PART NO.	TUBE x MIP	CTN/MSTR
C74081LF	1/4" x 1/8"	10/200
C74082LF	1/4" x 1/4"	10/200
C74135LF	1/4" x 3/8"	10/200
C74136LF	1/4" x 1/2"	10/200
C74085LF	3/8" x 1/4"	10/200
C74086LF	3/8" x 3/8"	5/200
C74087LF	3/8" x 1/2"	5/200
C74088LF	1/2" x 3/8"	5/200
C74089LF	1/2" x 1/2"	125/250
C74090LF	5/8" x 1/2"	100/200

Pilot Line Breakaway Nut



• Lead Free

PART NO.	DESCRIPTION	CTN/MSTR
C74158LF	1/4" OD	10/200

Chrome Plated Compression Nut



• Lead Free

PART NO.	SIZE	CTN/MSTR
C74095	1/2"	50/400

Chrome Plated Compression Union



• Lead Free

PART NO.	TUBE SIZE	CTN/MSTR
N62006LF	3/8"	250/500
N62086LF	1/2" x 3/8"	100/400
N62106LF	5/8" x 3/8"	50/200

Chrome Plated Compression Elbow



• Lead Free

PART NO.	TUBE SIZE	CTN/MSTR
N65106LF	5/8" x 3/8"	50/200

Chrome Plated Compression x FIP Connector



• Lead Free

PART NO.	TUBE x FIP	CTN/MSTR
N66066LF	3/8" x 3/8"	200/800
N66068LF	3/8" x 1/2"	100/400
N66088LF	1/2" x 1/2"	125/250

Chrome Plated Compression x MIP Connector



• Lead Free

PART NO.	TUBE x MIP	CTN/MSTR
N68066LF	3/8" x 3/8"	125/500
N68068LF	3/8" x 1/2"	100/400
N68088LF	1/2" x 1/2"	100/400

Chrome Plated Compression x Sweat Adapter



• Lead Free

PART NO.	TUBE x OD	CTN/MSTR
N66610LF	3/8" x 5/8" (1/2" swt)	100/200

Chrome Plated Compression x FIP Elbow



• Lead Free

PART NO.	TUBE x FIP	CTN/MSTR
N70066LF	3/8" x 3/8"	100/400
N70068LF	3/8" x 1/2"	100/400
N70086LF	1/2" x 3/8"	100/400

Chrome Plated Compression x MIP Elbow



• Lead Free

PART NO.	TUBE x MIP	CTN/MSTR
N69066LF	3/8" x 3/8"	100/400
N69068LF	3/8" x 1/2"	100/400

3' Chrome Plated Brass Cover Tubes



• Plain ends
(no threads)
• 20 gauge

PART NO.	DESCRIPTION	CTN/MSTR
T73125	1-1/4" OD x 3' tube	1/25
T73138	1-3/8" OD x 3' tube	1/25
T73150	1-1/2" OD x 3' tube	1/25
T73175	1-3/4" OD x 3' tube	1/25
T73200	2" OD x 3' tube	1/20

Short Flare Nut

Style 41S



PART NO.	TUBE SIZE	CTN/MSTR
F40001	3/16"	10/3000
F40002	1/4"	10/2000
F40003	5/16"	5/1000
F40004	3/8"	5/850
F40005	1/2"	5/750
F40006	5/8"	5/450
F40007	3/4"	3/201
F40126	7/8"	3/99

Long Flare Nut

Style 141L



PART NO.	TUBE SIZE	CTN/MSTR
F40008	3/8"	5/750
F40131	1/4"	10/1000
F40132	1/2"	5/400
F40133	5/8"	5/300

Short Forged Flare Nut

Style 141S



PART NO.	TUBE SIZE	CTN/MSTR
F40009	1/4"	10/1500
F40010	3/8"	5/800
F40011	1/2"	5/600
F40012	5/8"	5/400
F40013	3/8"x 1/4"	5/800
F40014	1/2"x 3/8"	5/450
F40119	5/8"x 1/2"	5/300

Flare Plug

Style 39



PART NO.	TUBE SIZE	CTN/MSTR
F40015	1/4"	10/1200
F40016	3/8"	5/600
F40017	1/2"	5/500
F40018	5/8"	5/250

Flare Cap

Style 40



PART NO.	TUBE SIZE	CTN/MSTR
F40019	1/4"	10/1000
F40098	5/16"	5/500
F40020	3/8"	5/1500
F40021	1/2"	5/600
F40022	5/8"	5/600

Flare Tee

Style 44



PART NO.	TUBE SIZE	CTN/MSTR
F40033	1/4"	10/500
F40034	5/16"	5/500
F40035	3/8"	5/400
F40036	1/2"	5/250
F40037	5/8"	5/100
F40038	3/8"x 3/8"x 1/4"	5/300
F40039	1/2"x 1/2"x 3/8"	5/150
F40120	5/8"x 5/8"x 1/2"	5/150

Flare x MIP Branch Tee

Style 45



PART NO.	TUBE x MIP	CTN/MSTR
F40040	3/8"x 1/4"	5/400
F40041	3/8"x 3/8"	5/400

Female Flare Swivel

Style 70



PART NO.	TUBE SIZE	CTN/MSTR
F40125	1/4"	10/400
F40095	3/8"	10/350
F40096	1/2"	5/200
F40097	5/8"	5/150

Flare Union

Style 42



PART NO.	TUBE SIZE	CTN/MSTR
F40023	1/4"	10/800
F40024	5/16"	5/700
F40025	3/8"	5/400
F40026	1/2"	5/350
F40027	5/8"	5/300
F40100	3/4"	5/200
F40127	7/8"	3/100
F40028	3/8"x 1/4"	5/400
F40029	1/2"x 1/4"	5/500
F40030	1/2"x 3/8"	5/500
F40031	5/8"x 3/8"	5/300
F40032	5/8"x 1/2"	5/300

Flare x MIP Half Union

Style 48



PART NO.	TUBE x MIP	CTN/MSTR
F40063	1/4" x 1/8"	10/200
F40064	1/4" x 1/4"	10/1500
F40107	1/4" x 3/8"	5/600
F40108	1/4" x 1/2"	5/600
F40065	5/16" x 1/8"	5/800
F40066	5/16" x 1/4"	5/700
F40067	3/8" x 1/8"	5/600
F40068	3/8" x 1/4"	5/700
F40069	3/8" x 3/8"	5/600
F40070	3/8" x 1/2"	5/450
F40071	3/8" x 3/4"	3/250
F40072	1/2" x 1/4"	5/300
F40073	1/2" x 3/8"	3/201
F40074	1/2" x 1/2"	5/350
F40075	1/2" x 3/4"	3/201
F40109	5/8" x 3/8"	5/300
F40076	5/8" x 1/2"	5/300
F40077	5/8" x 3/4"	3/201
F40110	3/4" x 1/2"	3/200
F40112	3/4" x 3/4"	3/201
F40122	7/8" x 3/4"	3/99

D

Flare Elbow

Style 55



PART NO.	TUBE SIZE	CTN/MSTR
F40078	1/4"	10/1000
F40079	3/8"	10/500
F40080	1/2"	10/550
F40081	5/8"	5/150

Flare x FIP Elbow

Style 50



PART NO.	TUBE x FIP	CTN/MSTR
F40104	1/4" x 1/4"	10/700
F40105	1/4" x 3/8"	5/700
F40056	3/8" x 1/4"	5/600
F40057	3/8" x 3/8"	5/650
F40058	3/8" x 1/2"	5/200
F40059	1/2" x 3/8"	5/400
F40060	1/2" x 1/2"	5/300
F40061	5/8" x 1/2"	5/250
F40106	5/8" x 3/4"	3/201
F40135	1/2" x 3/4"	3/201

Flare x FIP Coupling

Style 46



PART NO.	TUBE x FIP	CTN/MSTR
F40042	1/4" x 1/8"	10/1500
F40043	1/4" x 1/4"	10/1000
F40117	1/4" x 3/8"	5/700
F40118	1/4" x 1/2"	5/500
F40044	5/16" x 1/8"	5/1000
F40045	5/16" x 1/4"	5/1000
F40047	3/8" x 1/4"	5/800
F40048	3/8" x 3/8"	5/500
F40049	3/8" x 1/2"	5/500
F40050	3/8" x 3/4"	3/300
F40051	1/2" x 1/4"	5/500
F40052	1/2" x 3/8"	5/500
F40053	1/2" x 1/2"	5/400
F40054	1/2" x 3/4"	3/300
F40055	5/8" x 1/2"	5/300
F40101	5/8" x 3/4"	3/250
F40102	3/4" x 1/2"	3/99
F40103	3/4" x 3/4"	3/99
F40121	7/8" x 3/4"	3/99

Flare x MIP Elbow

Style 49



PART NO.	TUBE x MIP	CTN/MSTR
F40082	1/4" x 1/8"	10/800
F40083	1/4" x 1/4"	10/1000
F40113	1/4" x 3/8"	5/600
F40084	5/16" x 1/8"	5/800
F40085	5/16" x 1/4"	5/800
F40086	3/8" x 1/8"	5/650
F40087	3/8" x 1/4"	5/650
F40088	3/8" x 3/8"	5/600
F40089	3/8" x 1/2"	5/400
F40091	1/2" x 3/8"	5/400
F40114	1/2" x 1/4"	5/400
F40092	1/2" x 1/2"	5/300
F40093	1/2" x 3/4"	3/150
F40128	5/8" x 3/8"	5/200
F40094	5/8" x 1/2"	5/200
F40115	5/8" x 3/4"	5/150
F40111	3/4" x 1/2"	3/120
F40116	3/4" x 3/4"	3/99

Space Heater Fittings

Nut

• 9/16"-24 Fine threaded flare



PART NO.	OD	CTN/MSTR
F41002	3/8"x 1/4"	1/1

Cap

• 9/16"-24 Fine threaded flare



PART NO.	OD	CTN/MSTR
F41003	3/8"	10/750

Union

• 9/16"-24 Fine threaded flare



PART NO.	OD	CTN/MSTR
F41008	3/8"	5/325

Female Coupling

• 9/16"-24 Fine threaded flare



PART NO.	OD x FIP	CTN/MSTR
F41004	3/8"x 3/8"	1/1
F41005	3/8"x 1/2"	1/1

Male Half Union

• 9/16"-24 Fine threaded flare



PART NO.	OD x MIP	CTN/MSTR
F41006	3/8"x 3/8"	1/1
F41007	3/8"x 1/2"	1/1

Tee

• 9/16"-24 Fine threaded flare



PART NO.	OD	CTN/MSTR
F41009	3/8"	10/500

Female Elbow

• 9/16"-24 Fine threaded flare



PART NO.	OD x FIP	CTN/MSTR
F41011	3/8" x 1/2"	10/250

Male Elbow

• 9/16"-24 Fine threaded flare



PART NO.	OD x MIP	CTN/MSTR
F41012	3/8" x 3/8"	10/100
F41013	3/8" x 1/2"	10/100

Gas Range Fittings

Flare x Male



PART NO.	OD x MIP	CTN/MSTR
F48108	5/8" (15/16-16)x 1/2"	1/1
F481012	5/8" (15/16-16)x 3/4"	1/1

Flare x Female



PART NO.	OD x FIP	CTN/MSTR
F46108	5/8"(15/16-16) x 1/2"	1/1

Flare Cap & Nut



PART NO.	SIZE	CTN/MSTR
F401516 (cap)	15/16"	1/1
F411516 (nut)	15/16"	1/1



Yellow Brass 90° Elbow



PART NO.	IPT	CTN/MSTR
P20002	1/8"	1/1
P20004	1/4"	1/1
P20006	3/8"	1/1
P20008	1/2"	1/1

Yellow Brass 90° Male Elbow



PART NO.	IPT	CTN/MSTR
P13986	1/2"	1/1

Yellow Brass 90° Street Elbow



PART NO.	IPT	CTN/MSTR
P16002	1/8"	1/1
P16004	1/4"	1/1
P16006	3/8"	1/1
P16008	1/2"	1/1

Yellow Brass 45° Elbow



PART NO.	IPT	CTN/MSTR
P10452	1/8"	1/1
P10454	1/4"	1/1

Yellow Brass 45° Street Elbow



PART NO.	IPT	CTN/MSTR
P12402	1/8"	1/1
P12404	1/4"	1/1
P12408	1/2"	1/1

Yellow Brass Tee



PART NO.	IPT	CTN/MSTR
P10012	1/8"	1/1
P10014	1/4"	1/1
P10016	3/8"	1/1
P10018	1/2"	1/1

Yellow Brass Bell Reducer



PART NO.	IPT	CTN/MSTR
P19062	3/8" x 1/8"	1/1
P19082	1/2" x 1/8"	1/1
P19084	1/2" x 1/4"	1/1
P19086	1/2" x 3/8"	1/1
P19128	3/4" x 1/2"	1/1

Yellow Brass Coupling



PART NO.	IPT	CTN/MSTR
P10032	1/8"	1/1
P10034	1/4"	1/1
P10036	3/8"	1/1
P10038	1/2"	1/1
P10312	3/4"	1/1

Yellow Brass Cap



PART NO.	IPT	CTN/MSTR
P10082	1/8"	1/1
P10084	1/4"	1/1
P10086	3/8"	1/1
P10088	1/2"	1/1
P10812	3/4"	1/1

Yellow Brass Square Head Plug



PART NO.	IPT	CTN/MSTR
P10092	1/8"	1/1
P10094	1/4"	1/1
P10096	3/8"	1/1
P10098	1/2"	1/1
P10912	3/4"	1/1

Yellow Brass HEX Head Plug



PART NO.	IPT	CTN/MSTR
P12102	1/8"	1/1
P12104	1/4"	1/1
P12106	3/8"	1/1
P12108	1/2"	1/1
P12112	3/4"	1/1

Yellow Brass Countersunk Plug



PART NO.	IPT	CTN/MSTR
P20092	1/8"	1/1
P20094	1/4"	1/1
P20096	3/8"	1/1
P20098	1/2"	1/1

Yellow Brass Long Nipple



PART NO.	IPT	CTN/MSTR
P13224	1/8" x 1-1/2"	1/1
P13232	1/8" x 2"	1/1
P13424	1/4" x 1-1/2"	1/1
P13432	1/4" x 2"	1/1
P13624	3/8" x 1-1/2"	1/1
P13632	3/8" x 2"	1/1

Yellow Brass Lock Nut



PART NO.	IPT	CTN/MSTR
P11102	1/8"	1/1
P11104	1/4"	1/1
P11106	3/8"	1/1
P11108	1/2"	1/1

Yellow Brass HEX Nipple



PART NO.	IPT	CTN/MSTR
P12202	1/8"	1/1
P12204	1/4"	1/1
P12206	3/8"	1/1
P12208	1/2"	1/1
P12212	3/4"	1/1
P12342	1/4" x 1/8"	1/1
P12362	3/8" x 1/8"	1/1
P12364	3/8" x 1/4"	1/1
P12386	1/2" x 3/8"	1/1
P12328	3/4" x 1/2"	1/1

Yellow Brass HEX Bushing



PART NO.	IPT	CTN/MSTR
P11042	1/4" x 1/8"	1/1
P11062	3/8" x 1/8"	1/1
P11064	3/8" x 1/4"	1/1
P11082	1/2" x 1/8"	1/1
P11084	1/2" x 1/4"	1/1
P11086	1/2" x 3/8"	1/1
P11122	3/4" x 1/8"	1/1
P11124	3/4" x 1/4"	1/1
P11126	3/4" x 3/8"	1/1
P11128	3/4" x 1/2"	1/1

Yellow Brass Face Bushing



PART NO.	IPT	CTN/MSTR
P11964	3/8" x 1/4"	1/1
P11986	1/2" x 3/8"	1/1
P11928	3/4" x 1/2"	1/1

Yellow Brass Close Nipple



PART NO.	IPT	CTN/MSTR
P11202	1/8"	1/1
P11204	1/4"	1/1
P11206	3/8"	1/1
P11208	1/2"	1/1

Brass PEX Coupling



• Lead Free

PART NO.	SIZE	CTN/MSTR
C76001LF	1/2"	100/1000
C76002LF	3/4"	50/500
C76003LF	1"	50/300
C76004LF	3/4" x 1/2"	50/500
C76005LF	1" x 3/4"	25/250

Brass PEX 90° Elbow



• Lead Free

PART NO.	SIZE	CTN/MSTR
C76008LF	1/2"	100/500
C76009LF	3/4"	50/250
C76010LF	1"	25/100

Brass PEX x MIP 90° Elbow



• Lead Free

PART NO.	SIZE	CTN/MSTR
C76013LF	1/2" x 1/2"	25/100

Brass PEX Equal Tee



• Lead Free

PART NO.	SIZE	CTN/MSTR
C76014LF	1/2"	50/500
C76015LF	3/4"	50/250
C76016LF	1"	25/100

Brass PEX Tee



• Lead Free

PART NO.	SIZE	CTN/MSTR
C76017LF	1/2" x 1/2" x 3/4"	50/250
C76018LF	3/4" x 1/2" x 1/2"	50/250
C76019LF	3/4" x 1/2" x 3/4"	25/250
C76020LF	3/4" x 3/4" x 1/2"	25/250
C76021LF	1" x 3/4" x 3/4"	25/100
C76022LF	1" x 1" x 1/2"	25/100
C76023LF	1" x 1" x 3/4"	25/100

Brass PEX x Female Sweat Adapter



• Lead Free

PART NO.	PEX x FSW	CTN/MSTR
C76027LF	1/2" x 1/2"	100/500
C76028LF	3/4" x 3/4"	50/250
C76029LF	1/2" x 3/4"	25/250
C76030LF	1" x 1"	25/200

Brass PEX x Male Adapter



• Lead Free

PART NO.	PEX x MIP	CTN/MSTR
C76034LF	1/2" x 1/2"	25/400
C76035LF	1/2" x 3/4"	25/200
C76036LF	3/4" x 3/4"	50/250
C76037LF	1" x 1"	50/250
C76038LF	1" x 3/4"	25/100

Brass PEX x FIP Female Adapter



• Lead Free

PART NO.	PEX x FIP	CTN/MSTR
C76041LF	1/2" x 1/2"	50/250
C76042LF	1/2" x 3/4"	50/200
C76043LF	3/4" x 3/4"	25/200
C76044LF	1" x 1"	25/250

Brass PEX x Male Sweat Adapter



• Lead Free

PART NO.	PEX x MALE	CTN/MSTR
C76047LF	3/8" x 1/2"	50/500
C76048LF	1/2" x 1/2"	50/500
C76049LF	1/2" x 3/4"	25/100
C76050LF	3/4" x 3/4"	50/250
C76051LF	1" x 1"	25/100

Brass PEX x FIP 90° Elbow with Swivel Plastic Nut



• Lead Free

PART NO.	PEX x FIP	CTN/MSTR
C76060LF	1/2" x 1/2"	50/200

Brass PEX Ball Valve



• Lead Free

PART NO.	PEX x PEX	CTN/MSTR
B63050LF	1/2"	10/100
B63075LF	3/4"	10/100
B63100LF	1"	6/48

Brass PEX Plug



• Lead Free

PART NO.	PEX x FIP	CTN/MSTR
C76065LF	1/2"	100/1000
C76066LF	3/4"	100/500
C76067LF	1"	25/250

Brass PEX Crimp Ring



PART NO.	PEX x FIP	CTN/MSTR
C76070	3/8"	100/2000
C76071	1/2"	100/2000
C76072	3/4"	100/1000
C76073	1"	100/1000

Brass PEX x FIP Drop Ear 90° Elbow



- Lead Free

PART NO.	PEX x FIP	CTN/MSTR
C76080LF	1/2" x 1/2"	25/200
C76081LF	3/4" x 1/2"	25/200
C76079LF	1/2" x 1/2"	25/200

Oetiker PEX Stainless Steel Clamp



- The original patented PEX assembly clamp designated by ASTM F 2098
- Ingenious stepless design provides uniform compression for a 360° watertight seal
- Available for 3/8", 1/2", 3/4" and 1" ASTM F 876/877 pex tubing sizes
- Specified for use with ASTM F 1807 and F 2159 insert fittings

TECHNICAL DATA

APPLICATION:
PLUMBING & HYDRONIC
HEATING
HOT AND COLD WATER

MAXIMUM OPERATING
TEMPERATURE: 180°F

MAXIMUM OPERATING
PRESSURE (PSI): 100

MATERIAL: STAINLESS
STEEL UNS S304000

PART NO.	SIZE	CTN/MSTR
C76074	3/8"	100/2000
C76075	1/2"	100/2000
C76076	3/4"	50/2000
C76077	1"	50/1300

White Plastic PEX Equal Tee

- Listed by Warnock Hersey
- Meets ASTM F2159, F877 and CSA B1375
- Will not rust or corrode
- Unaffected by household cleaners and chemicals
- Smooth interior for better water flow
- Resists scale build-up
- Lead Free



PART NO.	SIZE	CTN/MSTR
C76700	1/2"	50/400
C76701	3/4"	25/200

White Plastic PEX Reducing Tee

- Listed by Warnock Hersey
- Meets ASTM F2159, F877 and CSA B1375
- Will not rust or corrode
- Unaffected by household cleaners and chemicals
- Smooth interior for better water flow
- Resists scale build-up
- Lead Free



PART NO.	SIZE	CTN/MSTR
C76709	1/2" x 1/2" x 3/4"	25/300
C76710	3/4" x 1/2" x 1/2"	25/300
C76711	3/4" x 1/2" x 3/4"	25/300
C76712	3/4" x 3/4" x 1/2"	25/300

White Plastic PEX Elbow

- Listed by Warnock Hersey
- Meets ASTM F2159, F877 and CSA B1375
- Will not rust or corrode
- Unaffected by household cleaners and chemicals
- Smooth interior for better water flow
- Resists scale build-up
- Lead Free



PART NO.	SIZE	CTN/MSTR
C76702	1/2"	50/500
C76703	3/4"	25/350
C76720	1"	10/150

White Plastic PEX Coupling

- Listed by Warnock Hersey
- Meets ASTM F2159, F877 and CSA B1375
- Will not rust or corrode
- Unaffected by household cleaners and chemicals
- Smooth interior for better water flow
- Resists scale build-up
- Lead Free



PART NO.	SIZE	CTN/MSTR
C76704	1/2"	50/1000
C76705	3/4"	50/600
C76706	3/4" x 1/2"	50/600
C76722	1"	25/200
C76723	1" x 3/4"	25/300

White Plastic PEX Adapter

- Listed by Warnock Hersey
- Meets ASTM F2159, F877 and CSA B1375
- Will not rust or corrode
- Unaffected by household cleaners and chemicals
- Smooth interior for better water flow
- Resists scale build-up
- Lead Free



PART NO.	PEX x MPT	CTN/MSTR
C76707	1/2" x 1/2"	50/500
C76708	3/4" x 3/4"	25/300
C76727	1" x 1"	10/150

White Plastic PEX Plug

- Listed by Warnock Hersey
- Meets ASTM F2159, F877 and CSA B1375
- Will not rust or corrode
- Unaffected by household cleaners and chemicals
- Smooth interior for better water flow
- Resists scale build-up
- Lead Free



PART NO.	SIZE	CTN/MSTR
C76740	1/2"	100/2000
C76741	3/4"	100/1000

Black Plastic PEX Equal Tee

- Listed by Warnock Hersey
- Meets ASTM F2159, F877 and CSA B1375
- Will not rust or corrode
- Unaffected by household cleaners and chemicals
- Smooth interior for better water flow
- Resists scale build-up
- Lead Free



PART NO.	SIZE	CTN/MSTR
C76762	1/2"	50/400
C76763	3/4"	50/200
C76773	1"	50/200

Black Plastic PEX Adapter

- Listed by Warnock Hersey
- Meets ASTM F2159, F877 and CSA B1375
- Will not rust or corrode
- Unaffected by household cleaners and chemicals
- Smooth interior for better water flow
- Resists scale build-up
- Lead Free



PART NO.	PEX x MPT	CTN/MSTR
C76759	1/2" x 1/2"	25/500
C76760	3/4" x 3/4"	25/300
C76761	1" x 1"	25/150

Black Plastic PEX Reducing Tee

- Listed by Warnock Hersey
- Meets ASTM F2159, F877 and CSA B1375
- Will not rust or corrode
- Unaffected by household cleaners and chemicals
- Smooth interior for better water flow
- Resists scale build-up
- Lead Free

D



PART NO.	SIZE	CTN/MSTR
C76764	1/2" x 1/2" x 3/4"	25/300
C76765	3/4" x 1/2" x 1/2"	25/300
C76766	3/4" x 1/2" x 3/4"	25/300
C76767	3/4" x 3/4" x 1/2"	25/300
C76774	3/4" x 3/4" x 1"	25/300
C76772	1" x 3/4" x 3/4"	25/300
C76776	1" x 3/4" x 1"	25/300
C76770	1" x 1" x 1/2"	25/300
C76775	1" x 1" x 3/4"	25/300

Black Plastic PEX Plug

- Listed by Warnock Hersey
- Meets ASTM F2159, F877 and CSA B1375
- Will not rust or corrode
- Unaffected by household cleaners and chemicals
- Smooth interior for better water flow
- Resists scale build-up
- Lead Free



PART NO.	SIZE	CTN/MSTR
C76768	1/2"	100/2000
C76769	3/4"	100/1000
C76771	1"	100/1000

Black Plastic PEX Elbow

- Listed by Warnock Hersey
- Meets ASTM F2159, F877 and CSA B1375
- Will not rust or corrode
- Unaffected by household cleaners and chemicals
- Smooth interior for better water flow
- Resists scale build-up
- Lead Free



PART NO.	SIZE	CTN/MSTR
C76751	1/2"	50/500
C76752	3/4"	50/350
C76753	1"	50/150

Black Plastic PEX Coupling

- Listed by Warnock Hersey
- Meets ASTM F2159, F877 and CSA B1375
- Will not rust or corrode
- Unaffected by household cleaners and chemicals
- Smooth interior for better water flow
- Resists scale build-up
- Lead Free



PART NO.	SIZE	CTN/MSTR
C76754	1/2"	50/1000
C76755	3/4"	50/600
C76756	3/4" x 1/2"	50/600
C76757	1"	50/200
C76758	1" x 3/4"	50/300

PlumBite Push On Fittings

- Heat free method for joining Copper, CPVC and PEX tube and are designed to save time and money on installations
- To make an effective joint with PEX tube, the included liner must be used. (DO NOT SUBSTITUTE with other manufacturer's liner.)
- Push fit
- Reduced installation time
- Ideal for service and repair
- "O-ring" design for leak free seals
- EPDM O-ring seal
- 316 Stainless steel retaining ring
- Designed for use with ASTM B88 hard drawn and annealed copper tube, type K, L, or M, in the 1/2" through 3/4" size range; CPVC water tube per ASTM D2846/2846M and PEX tube that meets the requirements of ASTM F876 & F877
- Operate at temperatures from 0° to 250°F at a maximum working pressure of 200 PSI
- Sold in bag quantity only



Type of Service	System Operating Conditions
FLUIDS	
Hot and Cold Potable Water	32°F to 200°F, max. 200 PSI
Potable Water System Flushing	Compliant with major plumbing codes
Chilled Water w/Corrosion Inhibitors	0°F to 250°F, max 200 PSI
	Ethylene Glycol - 50% max. concentration
	Propylene Glycol - 50% max. concentration
Hydronic Heating	0°F to 250°F, max 200 concentration
	Ethylene Glycol - 50% max. concentration
	Propylene Glycol - 50% max. concentration
Rainwater/Greywater	32° F to 250°F, max. 200 PSI

Coupling



• Lead Free

PART NO.	SIZE	CTN/MSTR
C76500LF	1/2"	5/100
C76501LF	3/4"	5/100

Reducer Coupling



• Lead Free

PART NO.	SIZE	CTN/MSTR
C76502LF	3/4" x 1/2"	15/60

Adapter C x F



• Lead Free

PART NO.	SIZE	CTN/MSTR
C76503LF	1/2"	10/100
C76504LF	3/4"	20/60
C76553LF	1"	5/100

Adapter C x M



• Lead Free

PART NO.	SIZE	CTN/MSTR
C76505LF	1/2"	10/200
C76506LF	3/4"	5/100

90° Elbow



• Lead Free

PART NO.	SIZE	CTN/MSTR
C76507LF	1/2"	10/150
C76508LF	3/4"	5/80

Drop Ear 90° Elbow C x F



• Lead Free

PART NO.	SIZE	CTN/MSTR
C76509LF	1/2"	10/100

Tee



• Lead Free

PART NO.	SIZE	CTN/MSTR
C76510LF	1/2"	10/100
C76511LF	3/4"	10/100
C76512LF	3/4" x 3/4" x 1/2"	5/50
C76513LF	3/4" x 1/2" x 3/4"	5/50
C76514LF	3/4" x 1/2" x 1/2"	5/50

Cap



• Lead Free

PART NO.	SIZE	CTN/MSTR
C76515LF	1/2"	10/200
C76516LF	3/4"	5/150

Ball Valve



• Lead Free

PART NO.	SIZE	CTN/MSTR
C76561LF	1/2"	10/60
C76562LF	3/4"	10/40

Repair Coupling



• Lead Free

PART NO.	SIZE	CTN/MSTR
C76530LF	1/2"	5/70
C76531LF	3/4"	5/70
C76532LF	1"	5/40

Supply Stop



• Lead Free

PART NO.	SIZE	CTN/MSTR
C76570LF	Straight 1/2" x 3/8"OD	1/120
C76571LF	Angle 1/2" x 3/8"OD	1/120

Water Heater Connector



• Lead Free

PART NO.	PF x FIP x LENGTH	CTN/MSTR
C76605LF	1/2" x 3/4" x 12"	10/80
C76606LF	1/2" x 3/4" x 15"	10/80
C76607LF	1/2" x 3/4" x 18"	10/80
C76608LF	1/2" x 3/4" x 24"	10/80
C76612LF	3/4" x 3/4" x 12"	10/80
C76613LF	3/4" x 3/4" x 15"	10/80
C76614LF	3/4" x 3/4" x 18"	10/80
C76615LF	3/4" x 3/4" x 24"	10/80
C76616LF	1/2" valve x 3/4" x 18"	1/10
C76617LF	3/4" valve x 3/4" x 18"	1/10

Removal Tool



PART NO.	SIZE	CTN QTY
C76520	1/2"	1/500
C76521	3/4"	5/250
C76522	1"	5/200

Twist To Lock Plastic Fittings

- Reduced installation time
- Ideal for service and repair
- "O-ring" design for leak-free seals
- Working temps and pressure:
180PSI@68°F, 100PSI@150°F, 45PSI@180°F

INSTRUCTIONS FOR USE

To Connect: Squarely cut tubing or pipe to desired length, removing all burrs. Push fitting onto the end of tube or pipe. Fitting will grip before it seals. Ensure that tubing or pipe is pushed into the fitting until the end is fully seated into the internal tube stop.



To Lock Fitting: Twist the screw cap until colored line is no longer visible.

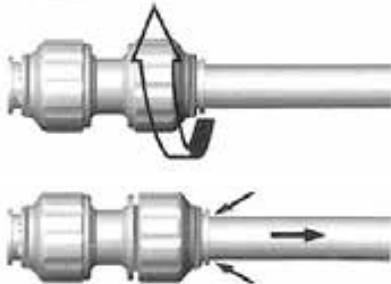

Plastic inserts are required for plastic pipe connections in heating installations. It is recommended to use pipe inserts for plastic pipe connections in standard residential plumbing (hot and cold water) installations.

Drop Ear Elbow CTS



PART NO.	SIZE	CTN/MSTR
C76800	1/2"	3/144

Enlarger Connector CTS STACK x CTS



PART NO.	SIZE	CTN/MSTR
C76801	3/4" x 1"	3/120

Female Adapter CTS x FIP



PART NO.	SIZE	CTN/MSTR
C76802	1/2" x 1/2"	3/321
C76803	1/2" x 3/4"	3/480
C76804	3/4" x 3/4"	3/216
C76805	1" x 1"	3/36

Female Garden Hose Adapter CTS x FGH



PART NO.	SIZE	CTN/MSTR
C76806	1/2" x 3/4"	3/168

Male Adapter CTS x MIP



PART NO.	SIZE	CTN/MSTR
C76807	1/2" x 1/2"	3/330
C76808	1/2" x 3/4"	3/282
C76809	3/4" x 3/4"	3/192

Male Elbow CTS x MIP



PART NO.	SIZE	CTN/MSTR
C76810	1/2" x 1/2"	3/168

Reducing Connector CTS x CTS Stem



PART NO.	SIZE	CTN/MSTR
C76811	1/2" x 3/4"	3/300

Swivel Elbow Union CTS x FIP



PART NO.	SIZE	CTN/MSTR
C76812	1/2" x 1/2"	3/160

Swivel Union Connector CTS x BC



PART NO.	SIZE	CTN/MSTR
C76813	1/2" x BC	3/300

Tube End Stop CTS



PART NO.	SIZE	CTN/MSTR
C76814	1/2"	3/336
C76815	3/4"	3/640
C76816	1"	3/135

Tube Elbow Union CTS x CTS Stem



PART NO.	SIZE	CTN/MSTR
C76817	1/2" x 1/2"	3/345
C76818	3/4" x 3/4"	3/180

Elbow Union CTS x CTS



PART NO.	SIZE	CTN/MSTR
C76819	1/2"	3/480
C76820	3/4"	3/60
C76821	1"	3/138

Tube Tee Union Connector CTS x CTS x CTS Stem



PART NO.	SIZE	CTN/MSTR
C76822	1/2" x 1/2" x 1/2"	3/180

Stack Tube Tee Union CTS



PART NO.	SIZE	CTN/MSTR
C76823	1/2"	3/195
C76824	3/4"	3/102

Union Connector CTS x CTS



PART NO.	SIZE	CTN/MSTR
C76825	3/8"	3/351
C76826	1/2" x 5/8"	3/528
C76827	1/2"	3/480
C76828	3/4" x 1/2"	3/330
C76829	3/4"	3/288
C76830	1" x 3/4"	3/180
C76831	1"	3/165

Tee Union CTS x CTS x CTS



PART NO.	SIZE	CTN/MSTR
C76832	1/2"	3/150
C76833	3/4" x 3/4" x 1/2"	3/180
C76834	3/4"	3/90
C76835	1"	3/78
C76836	1" x 3/4" x 3/4"	3/81
C76837	3/4" x 1/2" x 1/2"	3/180

Hand Valve Union Connector CTS x CTS



PART NO.	SIZE	CTN/MSTR
C76838	1/2"	3/210
C76839	3/4"	3/120

D

Plastic Push On Fittings

- Quick and easy installation
- Very durable and fatigue resistant
- Manufactured from safe, non-toxic materials meeting the requirements of the US FDA, WRAS, ANSI/NSF-51, 61 and SK Zert
- All connections can be assembled and disassembled repeatedly



1. Cut the part of the tube to be inserted into the fitting to plane the end.

2. Make sure to use a clean tube without any foreign material or cracks.



3. When inserting the tube, remove any obstructions before fully inserting the tube. Make sure the tube is fully inserted.

4. Inserting the tube into the fitting only takes moderate force. The tube or fitting should not be scratched or damaged in the process, as this is the main cause for water leaks later on.



5. To make sure that the fitting is properly connected to the tube, pull it once. After pulling, insert a spanner under the collet and push the tube into the fitting once more for a complete insertion.



6. When no play is desired for the fitting and tube, use our company's LC to eliminate the play of the fitting.



7. Make sure to completely eliminate pressure before disassembling the fitting.

8. When disassembling the tube, push the clip in direction to the main assembly and then pull the tube out for easy disassembling.

9. Fittings and tubes can be reused.

Straight Needle Valve Tube OD x MIP



PART NO.	SIZE	CTN/MSTR
C76840	1/4" x 1/4"	400/1600
C76841	3/8" x 3/8"	100/400

Straight Needle Valve Tube OD



PART NO.	SIZE	CTN/MSTR
C76842	1/4"	100/400
C76843	3/8"	150/600

Angle Valve Tube OD x FIP



PART NO.	SIZE	CTN/MSTR
C76844	1/4" x 1/4"	300/1200
C76845	3/8" x 3/8"	100/400

Straight Valve Tube OD x MIP



PART NO.	SIZE	CTN/MSTR
C76846	1/4" x 1/4"	50/600
C76847	3/8" x 3/8"	100/400

Straight Valve Tube OD x Tube OD



PART NO.	SIZE	CTN/MSTR
C76848	1/4"	150/600
C76849	3/8"	100/400

End Cap Tube OD



PART NO.	SIZE	CTN/MSTR
C76850	1/4"	500/3600
C76851	3/8"	600/2400
C76852	1/2"	400/1600

Plug Tube OD



PART NO.	SIZE	CTN/MSTR
C76853	1/4"	600/2400
C76854	3/8"	1000/4000
C76855	1/2"	500/2000

Union & Reducing Union Tube OD x Tube OD



PART NO.	SIZE	CTN/MSTR
C76856	1/4"	700/2800
C76857	3/8" x 1/4"	250/1000
C76858	3/8" x 3/8"	250/1000
C76859	1/2" x 3/8"	200/800

Bulkhead Union Tube OD x Tube OD



PART NO.	SIZE	CTN/MSTR
C76860	1/4" x 1/4"	200/800
C76861	3/8" x 3/8"	200/800
C76862	1/2" x 3/8"	100/400

Tee & Reducing Tee Tube OD x Tube OD x Tube OD



PART NO.	SIZE	CTN/MSTR
C76863	1/4"	400/1600
C76864	3/8" x 3/8" x 1/4"	200/800
C76865	3/8"	150/600
C76866	1/2" x 1/2" x 3/8"	100/400
C76867	1/2"	100/400

Elbow Tube OD x Tube OD



PART NO.	SIZE	CTN/MSTR
C76868	1/4"	700/2800
C76869	3/8"	300/1200
C76870	1/2"	150/600

Coupling Tube OD x FIP



PART NO.	SIZE	CTN/MSTR
C76871	1/4" x 1/8"	400/1600
C76872	1/4" x 1/4"	600/2400
C76873	3/8" x 1/4"	300/1200

Kitchen Faucet Adapter Tee FIP x MIP x Tube OD



PART NO.	SIZE	CTN/MSTR
C76874	1/2" x 1/2" x 1/4"	100/400
C76875	1/2" x 1/2" x 3/8"	100/400

Connector Tube OD x MIP



PART NO.	SIZE	CTN/MSTR
C76876	1/4" x 1/8"	800/3200
C76877	1/4" x 1/4"	800/3200
C76878	1/4" x 3/8"	600/2400
C76879	3/8" x 1/4"	400/1600
C76880	3/8" x 3/8"	400/1600
C76881	3/8" x 1/2"	200/800
C76882	1/2" x 3/8"	300/1200
C76883	1/2" x 1/2"	200/800

Elbow Tube OD x MIP



PART NO.	SIZE	CTN/MSTR
C76884	1/4" x 1/8"	800/3200
C76885	1/4" x 1/4"	600/2400
C76886	1/4" x 3/8"	500/2000
C76887	3/8" x 1/4"	800/3200
C76888	3/8" x 3/8"	300/1200

Elbow Adapter Tube OD x Tube OD Stem



PART NO.	SIZE	CTN/MSTR
C76889	1/4" x 1/4"	500/2000
C76890	3/8" x 3/8"	200/800

Connector Tube OD Stem x Tube ID



PART NO.	SIZE	CTN/MSTR
C76891	3/8" x 3/8"	800/3200
C76892	3/8" x 1/2"	200/800
C76893	1/2" x 1/2"	400/1600

Red Brass Pipe Nipples - Lead Free



- Meets ASTM B687
- Lead Free

PART NO.	IPT	CTN/MSTR
N20000	1/8" x close	200/800
N20001	1/8" x 1-1/2"	200/800
N20002	1/8" x 2"	200/800
N20003	1/8" x 2-1/2"	200/800
N20004	1/8" x 3"	200/800
N20005	1/8" x 3-1/2"	100/400
N20006	1/8" x 4"	100/400
N20007	1/8" x 4-1/2"	100/400
N20008	1/8" x 5"	100/400
N20009	1/8" x 5-1/2"	100/400
N20010	1/8" x 6"	100/400
N20012	1/8" x 7"	1/400
N20014	1/8" x 8"	1/400
N21000	1/4" x close	150/600
N21001	1/4" x 1-1/2"	100/800
N21002	1/4" x 2"	100/800
N21003	1/4" x 2-1/2"	100/800
N21004	1/4" x 3"	50/400
N21005	1/4" x 3-1/2"	50/400
N21006	1/4" x 4"	50/200
N21007	1/4" x 4-1/2"	50/200
N21008	1/4" x 5"	40/320
N21009	1/4" x 5-1/2"	40/320
N21010	1/4" x 6"	40/320
N21014	1/4" x 8"	1/150
N21022	1/4" x 12"	1/100
N22000	3/8" x close	100/400
N22001	3/8" x 1-1/2"	100/400
N22002	3/8" x 2"	80/320
N22003	3/8" x 2-1/2"	80/320
N22004	3/8" x 3"	50/200
N22005	3/8" x 3-1/2"	40/320
N22006	3/8" x 4"	40/320
N22007	3/8" x 4-1/2"	35/280
N22008	3/8" x 5"	30/120
N22009	3/8" x 5-1/2"	30/120
N22010	3/8" x 6"	30/120
N22014	3/8" x 8"	1/160
N22018	3/8" x 10"	1/120
N22022	3/8" x 12"	1/110
N23000	1/2" x close	75/600
N23001	1/2" x 1-1/2"	60/480
N23002	1/2" x 2"	50/200
N23003	1/2" x 2-1/2"	35/280
N23004	1/2" x 3"	35/280
N23005	1/2" x 3-1/2"	25/100
N23006	1/2" x 4"	25/100
N23007	1/2" x 4-1/2"	25/100
N23008	1/2" x 5"	25/100

Red Brass Pipe Nipples cont...

PART NO.	IPT	CTN/MSTR
N23009	1/2" x 5-1/2"	25/100
N23010	1/2" x 6"	25/100
N23012	1/2" x 7"	1/100
N23014	1/2" x 8"	1/100
N23016	1/2" x 9"	1/100
N23018	1/2" x 10"	1/100
N23020	1/2" x 11"	1/100
N23022	1/2" x 12"	1/100
N24000	3/4" x close	40/320
N24001	3/4" x 1-1/2"	30/240
N24002	3/4" x 2"	30/240
N24003	3/4" x 2-1/2"	25/200
N24004	3/4" x 3"	25/100
N24005	3/4" x 3-1/2"	35/140
N24006	3/4" x 4"	35/140
N24007	3/4" x 4-1/2"	30/120
N24008	3/4" x 5"	30/120
N24009	3/4" x 5-1/2"	25/100
N24010	3/4" x 6"	25/100
N24012	3/4" x 7"	1/65
N24014	3/4" x 8"	1/65
N24016	3/4" x 9"	1/45
N24018	3/4" x 10"	1/45
N24022	3/4" x 12"	1/45
N25000	1" x close	25/200
N25002	1" x 2"	25/200
N25003	1" x 2-1/2"	40/160
N25004	1" x 3"	40/160
N25005	1" x 3-1/2"	25/100
N25006	1" x 4"	25/100
N25007	1" x 4-1/2"	25/100
N25008	1" x 5"	20/80
N25009	1" x 5-1/2"	10/40
N25010	1" x 6"	10/40
N25012	1" x 7"	1/40
N25014	1" x 8"	1/40
N25016	1" x 9"	1/30
N25018	1" x 10"	1/30
N25022	1" x 12"	1/30
N27000	1-1/4" x close	25/100
N27002	1-1/4" x 2"	25/100
N27003	1-1/4" x 2-1/2"	10/80
N27004	1-1/4" x 3"	10/80
N27005	1-1/4" x 3-1/2"	1/40
N27006	1-1/4" x 4"	10/40
N27007	1-1/4" x 4-1/2"	10/40
N27008	1-1/4" x 5"	10/40
N27009	1-1/4" x 5-1/2"	10/40
N27010	1-1/4" x 6"	10/40
N27014	1-1/4" x 8"	1/25
N27016	1-1/4" x 9"	1/20

Red Brass Pipe Nipples cont...

PART NO.	IPT	CTN/MSTR
N27018	1-1/4" x 10"	1/20
N27022	1-1/4" x 12"	1/20
N28000	1-1/2" x close	25/100
N28002	1-1/2" x 2"	20/80
N28003	1-1/2" x 2-1/2"	15/60
N28004	1-1/2" x 3"	15/60
N28005	1-1/2" x 3-1/2"	15/60
N28006	1-1/2" x 4"	15/60
N28007	1-1/2" x 4-1/2"	15/60
N28008	1-1/2" x 5"	10/40
N28009	1-1/2" x 5-1/2"	10/40
N28010	1-1/2" x 6"	10/40
N28014	1-1/2" x 8"	1/20
N28016	1-1/2" x 9"	1/15
N28018	1-1/2" x 10"	1/15
N28022	1-1/2" x 12"	1/15
N29000	2" x close	15/60
N29003	2" x 2-1/2"	10/40
N29004	2" x 3"	10/40
N29005	2" x 3-1/2"	10/40
N29006	2" x 4"	10/40
N29007	2" x 4-1/2"	10/40
N29008	2" x 5"	1/25
N29009	2" x 5-1/2"	1/25
N29010	2" x 6"	1/25
N29012	2" x 7"	1/10
N29014	2" x 8"	1/10
N29016	2" x 9"	1/10
N29018	2" x 10"	1/10
N29020	2" x 11"	1/10
N29022	2" x 12"	1/10
N30000	2-1/2" x close	1/40
N30004	2-1/2" x 3"	1/40
N30005	2-1/2" x 3-1/2"	1/20
N30006	2-1/2" x 4"	1/20
N30007	2-1/2" x 4-1/2"	1/20
N30008	2-1/2" x 5"	1/20
N30010	2-1/2" x 6"	1/20
N31000	3" x close	1/20
N31004	3" x 3"	1/20
N31005	3" x 3-1/2"	1/10
N31006	3" x 4"	1/10
N31008	3" x 5"	1/10
N31010	3" x 6"	1/10

D

Bronze 90° Elbow



• Lead Free

PART NO.	SIZE	CTN/MSTR
B74001LF	1/8"	150/600
B74002LF	1/4"	100/400
B74003LF	3/8"	75/300
B74004LF	1/2"	50/200
B74005LF	3/4"	25/100
B74006LF	1"	1/80
B74007LF	1-1/4"	1/50
B74008LF	1-1/2"	1/35
B74009LF	2"	1/20
B74343LF	3/4" x 1/2"	30/120
B74344LF	1" x 1/2"	25/100
B74345LF	1" x 3/4"	25/100
B74347LF	1-1/2" x 1-1/4"	1/40

SPECIFICATIONS:
ANSI B16.15
ANSI B2.1 (PIPE THREADS)
FED WW-P-460
FED WW-U-516
150 PSI @400°F WSP
225 PSI WOG@ -20°F / 150°F

D

Bronze 90° Street Elbow



• Lead Free

PART NO.	SIZE	CTN/MSTR
B74021LF	1/8"	200/800
B74022LF	1/4"	100/400
B74023LF	3/8"	60/240
B74024LF	1/2"	50/200
B74025LF	3/4"	25/100
B74026LF	1"	1/50
B74027LF	1-1/4"	1/40
B74028LF	1-1/2"	1/35
B74029LF	2"	1/20

Bronze 45° Elbow



• Lead Free

PART NO.	SIZE	CTN/MSTR
B74042LF	1/4"	120/480
B74044LF	1/2"	50/200
B74045LF	3/4"	25/100
B74046LF	1"	1/90

Bronze 45° Street Elbow



• Lead Free

PART NO.	SIZE	CTN/MSTR
B74066LF	1"	1/80
B74067LF	1-1/4"	1/50

Bronze Union



• Lead Free

PART NO.	SIZE	CTN/MSTR
B74262LF	1/4"	60/240
B74263LF	3/8"	30/120
B74264LF	1/2"	25/100
B74265LF	3/4"	20/80
B74266LF	1"	1/50
B74267LF	1-1/4"	1/35
B74268LF	1-1/2"	1/25
B74269LF	2"	1/18

Bronze Tee



• Lead Free

PART NO.	SIZE	CTN/MSTR
B74081LF	1/8"	120/480
B74082LF	1/4"	75/300
B74083LF	3/8"	50/200
B74084LF	1/2"	25/100
B74085LF	3/4"	1/85
B74086LF	1"	1/35
B74087LF	1-1/4"	1/35
B74088LF	1-1/2"	1/24
B74089LF	2"	1/15
B74090LF	2-1/2"	1/8
B74354LF	1/2" x 3/8"	35/140
B74396LF	3/4" x 3/8"	25/100
B74358LF	3/4" x 1/2" x 3/4"	1/100
B74359LF	3/4" x 1/2"	25/100
B74365LF	1" x 3/4"	1/70
B74369LF	1-1/4" x 3/4"	1/35
B74367LF	1-1/2" x 1-1/4"	1/25
B74368LF	2" x 1-1/2"	1/15

Bronze Cap



• Lead Free

PART NO.	SIZE	CTN/MSTR
B74181LF	1/8"	1/1200
B74182LF	1/4"	200/800
B74183LF	3/8"	150/600
B74184LF	1/2"	100/400
B74185LF	3/4"	50/200
B74186LF	1"	40/160
B74187LF	1-1/4"	1/100
B74188LF	1-1/2"	1/100
B74189LF	2"	1/70

Bronze Locknut



PART NO.	SIZE	CTN/MSTR
B74380LF	1/2"	150/600
B74381	3/4"	90/360
B74382	1"	60/240
B74384	1-1/2"	30/120

Bronze Coupling/ Reducer



• Lead Free

PART NO.	SIZE	CTN/MSTR
B74121LF	1/8"	200/800
B74122LF	1/4"	150/600
B74123LF	3/8"	100/400
B74124LF	1/2"	50/200
B74125LF	3/4"	5/100
B74126LF	1"	1/100
B74127LF	1-1/4"	1/175
B74128LF	1-1/2"	1/50
B74129LF	2"	1/30
B74132LF	4"	1/6
B74140LF	1/4" x 1/8"	150/600
B74142LF	3/8" x 1/4"	90/360
B74144LF	1/2" x 1/4"	75/300
B74145LF	1/2" x 3/8"	70/280
B74148LF	3/4" x 1/2"	45/180
B74150LF	1" x 3/4"	25/100
B74152LF	1-1/4" x 3/4"	1/90
B74153LF	1-1/4" x 1"	1/80
B74154LF	1-1/2" x 1/2"	1/75
B74155LF	1-1/2" x 3/4"	1/80
B74156LF	1-1/2" x 1"	1/65
B74157LF	1-1/2" x 1-1/4"	1/60
B74160LF	2" x 1-1/4"	1/40
B74161LF	2" x 1-1/2"	1/35

Bronze Extension Piece



• Lead Free

PART NO.	SIZE	CTN/MSTR
B74370LF	3/4"	40/160

Bronze Cored Square Head Plug



• Lead Free

PART NO.	SIZE	CTN/MSTR
B74284LF	1/2"	150/600
B74285LF	3/4"	100/400
B74286LF	1"	50/200
B74287LF	1-1/4"	35/140
B74288LF	1-1/2"	30/120
B74289LF	2"	1/75

Bronze Solid Square Head Plug



• Lead Free

PART NO.	SIZE	CTN/MSTR
B74301LF	1/8"	900/3600
B74302LF	1/4"	1/690
B74303LF	3/8"	1/310
B74304LF	1/2"	100/400
B74305LF	3/4"	50/200
B74306LF	1"	35/140

Bronze Countersunk Plug



• Lead Free

PART NO.	SIZE	CTN/MSTR
B74331LF	3"	1/32

Bronze Cross



• Lead Free

PART NO.	SIZE	CTN/MSTR
B74104LF	1/2"	25/100
B74105LF	3/4"	1/60
B74107LF	1-1/4"	1/24
B74108LF	1-1/2"	1/22

Bronze HEX Bushing



• Lead Free

PART NO.	SIZE	CTN/MSTR
B74200LF	1/4" x 1/8"	300/1200
B74201LF	3/8" x 1/8"	250/1000
B74202LF	3/8" x 1/4"	250/1000
B74203LF	1/2" x 1/8"	150/600
B74204LF	1/2" x 1/4"	150/600
B74205LF	1/2" x 3/8"	1/1000
B74206LF	3/4" x 1/8"	75/300
B74207LF	3/4" x 1/4"	80/320
B74208LF	3/4" x 3/8"	85/340
B74209LF	3/4" x 1/2"	90/360
B74210LF	1" x 1/4"	50/200
B74212LF	1" x 1/2"	50/200
B74213LF	1" x 3/4"	50/200
B74216LF	1-1/4" x 1/2"	1/120
B74217LF	1-1/4" x 3/4"	1/120
B74218LF	1-1/4" x 1"	1/120
B74220LF	1-1/2" x 3/8"	1/120
B74222LF	1-1/2" x 3/4"	1/85
B74223LF	1-1/2" x 1"	1/115
B74224LF	1-1/2" x 1-1/4"	1/120
B74228LF	2" x 3/4"	1/60
B74229LF	2" x 1"	1/60
B74230LF	2" x 1-1/4"	1/65
B74231LF	2" x 1-1/2"	1/65
B74232LF	2-1/2" x 2"	1/40
B74235LF	4" x 3"	1/12

Chrome Plated Nipples/Pipe Lengths



• Lead Free

PART NO.	SIZE	CTN/MSTR
N15100	3/8" x close	50/400
N15150	3/8" x 1-1/2"	25/400
N15200	3/8" x 2"	50/400
N15250	3/8" x 2-1/2"	50/300
N15300	3/8" x 3"	50/300
N15350	3/8" x 3-1/2"	50/200
N15400	3/8" x 4"	25/100
N15450	3/8" x 4-1/2"	50/200
N15500	3/8" x 5"	50/200
N15550	3/8" x 5-1/2"	25/100
N15600	3/8" x 6"	25/100
N15900	3/8" x 12"	25/50
N16100	1/2" x close	50/400
N16150	1/2" x 1-1/2"	50/400
N16200	1/2" x 2"	50/400
N16250	1/2" x 2-1/2"	75/300
N16300	1/2" x 3"	25/200
N16350	1/2" x 3-1/2"	50/200
N16400	1/2" x 4"	25/100
N16450	1/2" x 4-1/2"	25/100
N16500	1/2" x 5"	25/100
N16550	1/2" x 5-1/2"	25/100
N16600	1/2" x 6"	25/100
N16900	1/2" x 12"	25/50
N16918	1/2" x 18"	1/10
N16924	1/2" x 24"	1/10
N16936	1/2" x 36"	1/10
N17100	3/4" x close	50/100
N17150	3/4" x 1-1/2"	50/200
N17300	3/4" x 3"	1/30
N17400	3/4" x 4"	25/100
N17600	3/4" x 6"	25/100
N18100	1" x close	20/200
N18200	1" x 2"	20/200
N18250	1" x 2-1/2"	25/100
N18300	1" x 3"	25/100
N18400	1" x 4"	25/100
N18500	1" x 5"	25/50
N18600	1" x 6"	25/50

Chrome Plated 90° Elbow



• Lead Free

PART NO.	SIZE	CTN/MSTR
B50001LF	3/8"	25/100
B50002LF	1/2"	50/200
B50003LF	3/4"	25/100
B50004LF	1"	25/100

Chrome Plated 90° Street Elbow



• Lead Free

PART NO.	SIZE	CTN/MSTR
B50094LF	1/2"	25/100
B50098LF	3/4"	25/100
B50103LF	1"	1/50

Chrome Plated 45° Elbow



• Lead Free

PART NO.	SIZE	CTN/MSTR
B50011LF	3/8"	25/100
B50012LF	1/2"	50/200

Chrome Plated Tee



• Lead Free

PART NO.	SIZE	CTN/MSTR
B50031LF	3/8"	50/200
B50032LF	1/2"	50/100
B50033LF	3/4"	1/85

Chrome Plated Coupling



• Lead Free

PART NO.	SIZE	CTN/MSTR
B50041LF	3/8"	25/400
B50042LF	1/2"	50/200
B50043LF	3/4"	25/100
B50044LF	1"	25/100

Chrome Plated Reducer



• Lead Free

PART NO.	SIZE	CTN/MSTR
B50051LF	1/2"x 3/8"	70/280
B50052LF	3/4"x 1/2"	45/180

D

Chrome Plated Bushing



• Lead Free

PART NO.	SIZE	CTN/MSTR
B50072LF	1/2" x 3/8"	50/200
B50073LF	3/4" x 1/2"	90/360

Chrome Plated Union



• Lead Free

PART NO.	SIZE	CTN/MSTR
B50092LF	1/2"	25/100
B50097LF	3/4"	20/80
B50100LF	1"	25/100

Chrome Plated Plug



• Lead Free

PART NO.	SIZE	CTN/MSTR
B50096LF	1/2"	100/400
B50099LF	3/4"	25/100

Chrome Plated Cap



• Lead Free

PART NO.	SIZE	CTN/MSTR
B50081LF	3/8"	150/600
B50082LF	1/2"	100/400
B50083LF	3/4"	50/200



Male Hose To Male Pipe



PART NO.	MHT x MPT	CTN/MSTR
G20002	3/4" x 1/2"	20/200
G20003	3/4" x 3/4" (1/2" FIP tap)	20/200
G20004	3/4" x 1/2" (1/2" SWT)	50/200

Male Hose To Male Pipe - Lead Free



PART NO.	MHT x MPT	CTN/MSTR
G20102	3/4" x 1/2"	1/40
G20103	3/4" x 3/4" (1/2" FIP tap)	50/200

Male Hose To Male Hose



PART NO.	MHT x MHT	CTN/MSTR
G20008	3/4" x 3/4" (1/2" FIP tap)	20/200

Male Hose To Male Hose - Lead Free

• Lead Free



PART NO.	MHT x MHT	CTN/MSTR
G20108	3/4" x 3/4" (1/2" FIP tap)	1/40

Male Hose To Female Pipe



PART NO.	MHT x FPT	CTN/MSTR
G20010	3/4" x 1/2"	100/500
G20011	3/4" x 3/4"	20/200

Male Hose To Female Pipe - Lead Free

• Lead Free



PART NO.	MHT x FPT	CTN/MSTR
G20110	3/4" x 1/2"	1/40
G20111	3/4" x 3/4"	1/40

Female Hose To Male Pipe



PART NO.	FHT x MPT	CTN/MSTR
G20005	3/4" x 1/2" (1/2" SWT)	10/300
G20015	3/4" x 1/2"	50/250
G20016	3/4" x 3/4"	50/250
G20017	3/4" x 3/4" (1/2" FIP tap)	50/200

Female Hose To Male Pipe - Lead Free

• Lead Free



PART NO.	FHT x MPT	CTN/MSTR
G20115	3/4" x 1/2"	50/200
G20116	3/4" x 3/4"	1/40

Female Hose To Female Pipe



PART NO.	FHT x FPT	CTN/MSTR
G20020	3/4" x 1/2"	50/200
G20021	3/4" x 3/4"	50/200

Female Hose To Female Pipe - Lead Free

• Lead Free



PART NO.	FHT x FPT	CTN/MSTR
G20120	3/4" x 1/2"	1/40
G20121	3/4" x 3/4"	1/40

Female Hose To Female Hose Swivel



PART NO.	FHT x FHT	CTN/MSTR
G20030	3/4" x 3/4"	20/200

Female Hose To Female Hose Swivel - Lead Free

• Lead Free



PART NO.	FHT x FHT	CTN/MSTR
G20130	3/4" x 3/4"	1/40

Female Hose To Female Pipe Swivel



PART NO.	FHT x FPT	CTN/MSTR
G20031	3/4" x 1/2"	20/200
G20032	3/4" x 3/4"	125/250

D

Female Hose To Female Pipe Swivel - Lead Free



• Lead Free

PART NO.	FHT x FPT	CTN/MSTR
G20131	3/4" x 1/2"	1/40
G20132	3/4" x 3/4"	1/40

Hose Barb To Female Hose Swivel



• Lead Free

PART NO.	HB x FHT	CTN/MSTR
G20035	3/8" x 3/4"	10/400
G20036	1/2" x 3/4"	20/245
G20037	5/8" x 3/4"	10/400
G20038	3/4" x 3/4"	10/400

Hose Barb To Female Hose Swivel - Lead Free



• Lead Free

PART NO.	HB x FHT	CTN/MSTR
G20136	1/2" x 3/4"	50/200
G20137	5/8" x 3/4"	50/200
G20138	3/4" x 3/4"	50/200

Hose Barb To Male Hose



PART NO.	HB x MHT	CTN/MSTR
G20040	3/8" x 3/4"	10/300
G20041	1/2" x 3/4"	50/200
G20042	5/8" x 3/4"	1/200
G20043	3/4" x 3/4"	50/200

Hose Barb To Male Hose - Lead Free



• Lead Free

PART NO.	HB x MHT	CTN/MSTR
G20141	1/2" x 3/4"	50/200
G20142	5/8" x 3/4"	50/200
G20143	3/4" x 3/4"	50/200

Male Pipe To Female Hose Swivel



PART NO.	MPT x FHT	CTN/MSTR
G20045	1/4" x 3/4"	10/300
G20047	1/2" x 3/4"	50/200

Hose WYE



PART NO.	DESCRIPTION	CTN/MSTR
G20050	3/4" x 3/4"	20/200

Hose WYE - Lead Free



• Lead Free

PART NO.	DESCRIPTION	CTN/MSTR
G20150	3/4" x 3/4"	1/100

Garden Hose Shut Off



• Buna-N seals

PART NO.	DESCRIPTION	CTN/MSTR
G20051	Dual shut off/ green ABS	16/192
G20052	Single shut off/ green ABS	1/200
G20053	Brass hose with shut off "wye"	15/60
G20054	CP die cast with shut off "wye"	20/100

Garden Hose Cap



PART NO.	FHT	CTN/MSTR
G20055	3/4"	100/600
G20056	3/4" with chain	10/600

Garden Hose Cap - Lead Free



• Lead Free

PART NO.	FHT	CTN/MSTR
G20155	3/4" with washer	1/500

Garden Hose Washer



PART NO.	SIZE	CTN/MSTR
G20057	3/4" vinyl	1/5000
G20057R	3/4" red rubber	1/2500

Garden Hose Filter Washer



PART NO.	SIZE	CTN/MSTR
G20060	3/4"	10/1000

Evaporation Cooler Drain



PART NO.	MHT x FPT	CTN/MSTR
G20006	3/4" x 1/2"	25/200

Hose Barb To Male Pipe

• Barb refers to hose I.D.



PART NO.	BARB x MPT	CTN/MSTR
G25022	1/8" x 1/8"	10/100
G25032	3/16" x 1/8"	10/100
G25034	3/16" x 1/4"	10/100
G25042	1/4" x 1/8"	10/100
G25044	1/4" x 1/4"	10/100
G25046	1/4" x 3/8"	10/100
G25048	1/4" x 1/2"	10/100
G25052	5/16" x 1/8"	10/100
G25054	5/16" x 1/4"	10/100
G25056	5/16" x 3/8"	10/100
G25062	3/8" x 1/8"	10/100
G25064	3/8" x 1/4"	10/100
G25066	3/8" x 3/8"	10/100
G25068	3/8" x 1/2"	10/100
G25612	3/8" x 3/4"	10/100
G25084	1/2" x 1/4"	10/100
G25086	1/2" x 3/8"	10/100
G25088	1/2" x 1/2"	10/100
G25812	1/2" x 3/4"	10/100
G25106	5/8" x 3/8"	10/100
G25108	5/8" x 1/2"	10/100
G25101	5/8" x 3/4"	10/100
G25128	3/4" x 1/2"	10/100
G25121	3/4" x 3/4"	10/100
G25161	1" x 3/4"	10/100
G25169	1" x 1"	10/100

D

Hose Barb To Female Pipe

• Barb refers to hose I.D.



PART NO.	BARB x FPT	CTN/MSTR
G26022	1/8" x 1/8"	10/100
G26032	3/16" x 1/8"	10/100
G26034	3/16" x 1/4"	10/100
G26042	1/4" x 1/8"	10/100
G26044	1/4" x 1/4"	10/100
G26046	1/4" x 3/8"	10/100
G26052	5/16" x 1/8"	10/100
G26054	5/16" x 1/4"	10/100
G26056	5/16" x 3/8"	10/100
G26062	3/8" x 1/8"	10/100
G26064	3/8" x 1/4"	10/100
G26066	3/8" x 3/8"	10/100
G26068	3/8" x 1/2"	10/100
G26084	1/2" x 1/4"	10/100
G26086	1/2" x 3/8"	10/100
G26088	1/2" x 1/2"	10/100
G26121	3/4" x 3/4"	10/100
G26161	1" x 3/4"	10/100

Hose Barb To Male Pipe Elbow

• Barb refers to hose I.D.



PART NO.	BARB x MPT	CTN/MSTR
G27042	1/4" x 1/8"	10/100
G27044	1/4" x 1/4"	10/100
G27054	5/16" x 1/4"	10/100
G27062	3/8" x 1/8"	10/100
G27064	3/8" x 1/4"	10/100
G27066	3/8" x 3/8"	10/100
G27068	3/8" x 1/2"	10/100
G27084	1/2" x 1/4"	10/100
G27086	1/2" x 3/8"	10/100
G27088	1/2" x 1/2"	10/100
G27106	5/8" x 3/8"	10/100
G27108	5/8" x 1/2"	10/100

Barb To Barb Hose Splicers

• Barb refers to hose I.D.



PART NO.	BARB	CTN/MSTR
G29003	3/16"	10/100
G29004	1/4"	10/100
G29005	5/16"	10/100
G29006	3/8"	10/100
G29008	1/2"	10/100
G29010	5/8"	10/100

Hose Barb To Female Ball End Swivel

• Barb refers to hose I.D.



PART NO.	BARB x NPSM	CTN/MSTR
G28044	1/4" x 1/4"	10/100
G28066	3/8" x 3/8"	10/100
G28088	1/2" x 1/2"	10/100

Hose Barb Tee

• Barb refers to hose I.D.



PART NO.	BARB x BARB X BARB	CTN/MSTR
G24004	1/4"	10/100
G24006	3/8"	10/100

Nylon Hose Barb Splicer

• Barb refers to hose I.D.



PART NO.	BARB x BARB	CTN/MSTR
N10001	1/8" x 1/8"	10/100
N10002	1/4" x 1/4"	10/100
N10003	5/16" x 5/16"	10/100
N10004	3/8" x 3/8"	10/100
N10005	1/2" x 1/2"	10/100
N10006	5/8" x 5/8"	10/100
N10007	3/4" x 3/4"	10/100
N10008	1" x 1"	5/50

Nylon Hose Barb Tee

• Barb refers to hose I.D.



PART NO.	BARB x BARB	CTN/MSTR
N11001	1/8" x 1/8" x 1/8"	10/100
N11002	1/4" x 1/4" x 1/4"	10/100
N11003	3/8" x 3/8" x 3/8"	10/100
N11004	1/2" x 1/2" x 3/8"	10/100
N11005	1/2" x 1/2" x 1/2"	10/100
N11006	5/8" x 5/8" x 5/8"	10/100
N11007	3/4" x 3/4" x 3/4"	10/100
N11008	1" x 1" x 1"	5/50

Nylon Hose Barb Elbow

• Barb refers to hose I.D.



PART NO.	BARB x BARB	CTN/MSTR
N12001	1/4" x 1/4"	10/100
N12002	3/8" x 3/8"	10/100
N12003	1/2" x 1/2"	10/100
N12004	5/8" x 5/8"	10/100
N12005	3/4" x 3/4"	10/100
N12006	1" x 1"	5/50

Nylon Garden Hose Cap



PART NO.	FHT	CTN/MSTR
N06001	3/4"	10/100

Nylon Female Hose Barb Adapter

• Barb refers to hose I.D.



PART NO.	BARB x FPT	CTN/MSTR
N15001	1/2" x 1/2"	10/100

Nylon Hose Barb Adapter

• Barb refers to hose I.D.



PART NO.	MPT x BARB	CTN/MSTR
N14001	1/4" x 1/4"	10/100
N14002	1/4" x 3/8"	10/100
N14003	3/8" x 1/4"	10/100
N14004	3/8" x 3/8"	10/100
N14005	3/8" x 1/2"	10/100
N14006	1/2" x 1/4"	10/100
N14007	1/2" x 3/8"	10/100
N14008	1/2" x 1/2"	10/100
N14009	1/2" x 5/8"	10/100
N14010	1/2" x 3/4"	10/100
N14011	3/4" x 3/8"	10/100
N14012	3/4" x 1/2"	10/100
N14013	3/4" x 5/8"	10/100
N14014	3/4" x 3/4"	10/100
N14015	3/4" x 1"	5/50
N14016	1" x 1/2"	5/50
N14017	1" x 5/8"	5/50
N14018	1" x 3/4"	5/50
N14019	1" x 1"	5/50

Nylon Male Garden Hose To Female Pipe



PART NO.	MHT x FPT	CTN/MSTR
N18001	3/4" x 1/2"	10/100
N18002	3/4" x 3/4"	10/100

Nylon Male Garden Hose To Male Pipe



PART NO.	MHT x MPT	CTN/MSTR
N09001	3/4" x 1/2"	10/100
N09002	3/4" x 3/4"	10/100

Nylon Female Garden Hose To Female Pipe



PART NO.	FHT x FPT	CTN/MSTR
N07001	3/4" x 1/2"	10/100

Nylon Male Insert Adapter



- For flexible polyethylene plastic pipe
- NSF listed

NSF

PART NO.	SIZE	CTN/MSTR
I11001	1/2"	10/100
I11002	3/4"	10/100
I11003	1"	10/100
I11004	1-1/4"	10/100
I11005	1-1/2"	10/100
I11006	2"	10/100

Nylon Insert Combination Elbow



- For flexible polyethylene plastic pipe
- NSF listed

NSF

PART NO.	SIZE	CTN/MSTR
I11025	1/2"	10/100
I11026	3/4"	10/100
I11027	1"	10/100
I11028	1-1/4"	10/100

D Nylon Insert Coupling



- For flexible polyethylene plastic pipe
- NSF listed

NSF

PART NO.	SIZE	CTN/MSTR
I11007	1/2"	10/100
I11008	3/4"	10/100
I11009	1"	10/100
I11010	1-1/4"	10/100
I11011	1-1/2"	10/100
I11012	2"	10/100

Nylon Insert Elbow



- For flexible polyethylene plastic pipe
- NSF listed

NSF

PART NO.	SIZE	CTN/MSTR
I11013	1/2"	10/100
I11014	3/4"	10/100
I11015	1"	10/100
I11016	1-1/4"	10/100
I11017	1-1/2"	10/100
I11018	2"	5/50

Nylon Insert Tee



- For flexible polyethylene plastic pipe
- NSF listed

NSF

PART NO.	SIZE	CTN/MSTR
I11019	1/2"	10/100
I11020	3/4"	10/100
I11021	1"	10/100
I11022	1-1/4"	10/100
I11023	1-1/2"	10/100
I11024	2"	5/50

Poly Male Insert Adapter



- For flexible polyethylene plastic pipe
- NSF listed

PART NO.	SIZE	CTN/MSTR
I10001	1/2"	10/100
I10002	3/4"	10/250
I10003	1"	10/160
I10004	1-1/4"	10/80
I10005	1-1/2"	5/60
I10006	2"	5/40

Poly Insert Elbow



- For flexible polyethylene plastic pipe
- NSF listed

PART NO.	SIZE	CTN/MSTR
I10023	1/2"	10/300
I10024	3/4"	10/180
I10025	1"	10/100
I10026	1-1/4"	5/60
I10027	1-1/2"	5/40
I10028	2"	5/25

Poly Female Insert Adapter



- For flexible polyethylene plastic pipe
- NSF listed

PART NO.	SIZE	CTN/MSTR
I10007	1/2"	10/400
I10008	3/4"	10/250
I10009	1"	10/160
I10010	1-1/4"	10/80

Poly Insert Tee



- For flexible polyethylene plastic pipe
- NSF listed

PART NO.	SIZE	CTN/MSTR
I10029	1/2"	10/180
I10030	3/4"	10/100
I10031	1"	10/60
I10032	1-1/4"	5/40
I10033	1-1/2"	5/30
I10034	2"	5/15

Poly Insert Coupling



- For flexible polyethylene plastic pipe
- NSF listed

PART NO.	SIZE	CTN/MSTR
I10011	1/2"	10/400
I10012	3/4"	10/250
I10013	1"	10/160
I10014	1-1/4"	10/80
I10015	1-1/2"	5/60
I10016	2"	5/40

Poly Insert x MIP Combination Elbow



- For flexible polyethylene plastic pipe
- NSF listed

PART NO.	SIZE	CTN/MSTR
I10035	1/2"	10/300
I10036	3/4"	10/200
I10037	1"	10/100
I10038	1-1/4"	5/50
I10039	1-1/2"	5/50

Poly Reducing Insert Coupling



- For flexible polyethylene plastic pipe
- NSF listed

PART NO.	SIZE	CTN/MSTR
I10017	3/4" x 1/2"	10/300
I10018	1" x 1/2"	10/220
I10019	1" x 3/4"	10/220
I10020	1-1/4" x 1"	10/100
I10021	1-1/2" x 1-1/4"	5/15
I10022	2" x 1-1/2"	5/15

Poly Insert Reducing Tee



- For flexible polyethylene plastic pipe
- NSF listed

PART NO.	SIZE	CTN/MSTR
I10043	3/4" x 3/4" x 1/2"	1/1
I10044	3/4" x 1/2" x 1/2"	1/1
I10045	1" x 1" x 1/2"	1/1
I10046	1" x 1" x 3/4"	1/1
I10047	1" x 3/4" x 3/4"	1/1
I10048	1-1/2" x 1-1/2" x 1"	1/1
I10049	2" x 2" x 1"	1/1

Poly Male Insert Reducer



- For flexible polyethylene plastic pipe
- NSF listed

PART NO.	SIZE	CTN/MSTR
I10040	3/4" x 1/2"	10/300
I10041	1" x 3/4"	10/220
I10042	1-1/4" x 1"	10/100

Red Brass Male Insert Adapter



- For flexible polyethylene plastic pipe
- Lead free

PART NO.	SIZE	CTN/MSTR
I13001LF	1/2"	10/200
I13002LF	3/4"	10/200
I13003LF	1"	10/100
I13004LF	1 1/4"	10/100
I13005LF	1 1/2"	10/60
I13006LF	2"	5/40

Red Brass Insert Coupling



- For flexible polyethylene plastic pipe
- Lead free

PART NO.	SIZE	CTN/MSTR
I13016LF	3/4"	1/100
I13017LF	1"	1/100
I13018LF	1 1/4"	1/100
I13019LF	1 1/2"	1/100
I13020LF	2"	10/100

Red Brass Male Insert Reducer

D



- For flexible polyethylene plastic pipe
- Lead free

PART NO.	INSERT x MPT	CTN/MSTR
I13007LF	1" x 3/4"	1/100

Red Brass Insert Tee



- For flexible polyethylene plastic pipe
- Lead free

PART NO.	SIZE	CTN/MSTR
I13021LF	3/4"	1/100
I13022LF	1"	1/100
I13023LF	1 1/4"	10/50

Red Brass Female Insert Adapter



- For flexible polyethylene plastic pipe
- Lead free

PART NO.	SIZE	CTN/MSTR
I13010LF	3/4"	10/100
I13011LF	1"	1/200
I13012LF	1-1/4"	1/100
I13013LF	1-1/2"	1/100

Red Brass Insert Elbow



- For flexible polyethylene plastic pipe
- Lead free

PART NO.	SIZE	CTN/MSTR
I13024LF	3/4"	1/100
I13025LF	1"	1/100
I13026LF	1 1/4"	1/50

Red Brass Insert x MIP 90° Elbow



- For flexible polyethylene plastic pipe
- Lead free

PART NO.	INSERT	MIP	CTN/MSTR
I13031LF	3/4"	3/4"	1/100
I13032LF	1"	3/4"	1/100
I13033LF	1"	1"	10/100

Red Brass Insert Male Rope Adapter



- For flexible polyethylene plastic pipe
- Lead free

PART NO.	SIZE	CTN/MSTR
I13027LF	1"	1/100
I13029LF	1"x 1 1/4"	1/100

Red Brass Insert x Sweat Adapter



- For flexible polyethylene plastic pipe
- Lead free

PART NO.	INSERT	SWEAT	CTN/MSTR
I13036LF	3/4"	3/4"	10/100
I13037LF	1"	1"	10/200

Steel Male Insert Adapter



• For flexible polyethylene plastic pipe

PART NO.	SIZE	CTN/MSTR
I12001	1/2"	50/300
I12002	3/4"	25/200
I12003	1"	25/100
I12004	1-1/4"	12/96
I12005	1-1/2"	6/84
I12006	2"	5/40

Steel Female Insert Adapter



• For flexible polyethylene plastic pipe

PART NO.	SIZE	CTN/MSTR
I12007	1/2"	25/200
I12008	3/4"	25/150
I12009	1"	15/150
I12010	1-1/4"	12/96
I12011	1-1/2"	10/60
I12012	2"	4/20

Steel Insert Coupling



• For flexible polyethylene plastic pipe

PART NO.	SIZE	CTN/MSTR
I12013	1/2"	50/300
I12014	3/4"	25/200
I12015	1"	25/200
I12016	1-1/4"	12/96
I12017	1-1/2"	6/84
I12018	2"	5/40

INSERT FITTINGS VS HOSE BARBS?

Insert Fittings only fit polyethylene plastic pipe (water service pipe).

Hose Barbs are designed to fit the inside diameter of various rubber hose sizes.

Both types of fittings are normally secured with hose gear clamps.

Brass Angle Compression Needle Valve



PART NO.	COMP x MIP	CTN/MSTR
N10442LF	1/4" x 1/8"	20/400
N10444LF	1/4" x 1/4"	20/400

Brass Straight Compression Needle Valve



PART NO.	COMP x COMP	CTN/MSTR
N10544LF	1/4" x 1/4"	20/400
N10566LF	3/8" x 3/8"	20/400

D Brass Straight Compression Needle Valve



PART NO.	COMP x MIP	CTN/MSTR
N10664LF	3/8" x 1/4"	20/400

Brass Pipe Needle Valve



PART NO.	FIP x FIP	CTN/MSTR
N10944LF	1/4" x 1/4"	20/200

Brass Saddle Clamp



- Fits up to 3/4" iron pipe
- Fits up to 1" hard copper
- Unassembled

PART NO.	FPT	CTN/MSTR
N01038	1/8"	10/200

Brass Saddle Clamp With Valve



- Fits up to 3/4" iron pipe
- Fits up to 1" hard copper
- Unassembled

PART NO.	OD	CTN/MSTR
N01039	1/4"	10/200

Self Piercing Valve



- 1/4" OD compression outlet
- Fits 3/8" to 1.315" OD tube
- Lead Free

PART NO.	TUBE SIZE	CTN/MSTR
S92001	1/4"	50/100

Icemaker/Humidifier Kit



- 1/4" tubing
- Self piercing valve
- Brass fittings
- Lead Free

PART NO.	TUBE SIZE	CTN/MSTR
S92025	1/4" x 25' poly tubing	1/10
S92030	1/4" x 25' copper tubing	1/10
S92031	1/4" x 15' copper tubing	1/10

- Rated at 2 PSIG
- Cast bronze plug style

MADE IN THE
USA



Lever Handle

PART NO.	SIZE	CTN/MSTR
G17025	1/4"	1/25
G17037	3/8"	1/25
G17050	1/2"	1/50
G17075	3/4"	1/50
G17100	1"	1/25
G17125	1-1/4"	1/10
G17150	1-1/2"	1/10
G17200	2"	1/5



Square Head

PART NO.	SIZE	CTN/MSTR
G18025	1/4"	1/25
G18037	3/8"	1/25
G18050	1/2" AGA	1/50
G18075	3/4" AGA	1/50
G18100	1"	1/25
G18125	1-1/4"	1/10
G18150	1-1/2"	1/10
G18200	2"	1/5



Flat/Tee Head

PART NO.	SIZE	CTN/MSTR
G19025	1/4"	1/25
G19037	3/8"	1/25
G19050	1/2" AGA	1/50
G19075	3/4" AGA	1/50
G19100	1"	1/25
G19125	1-1/4"	1/10
G19150	1-1/2"	1/10
G19200	2"	1/5

Flare x Flare



• 30 PSI

PART NO.	SIZE	CTN/MSTR
N01014	3/8"	1/10

Female Pipe x Female Pipe



• 30 PSI

PART NO.	SIZE	CTN/MSTR
N01010	1/8"	1/10
N01011	1/4"	1/10

Female Pipe x Male Pipe



• 30 PSI

PART NO.	SIZE	CTN/MSTR
N01027	1/8"	1/10
N01028	1/4"	1/10
N01029	3/8"	1/10

Drain Cock Tee Handle with Bibb



• Hose x Male IPT

PART NO.	SIZE	CTN/MSTR
N01032	1/4"	1/500

Drain Cock External Seat



PART NO.	SIZE	CTN/MSTR
N01033	1/8"	1/1000
N01034	1/4"	1/1000

D

Drain Cock



PART NO.	SIZE	CTN/MSTR
N01001	1/8"	1/500
N01002	1/4"	1/500

Satin Brass Air Cock Female x Male Lever Handle HEX Shoulder



• Spring bottoms

PART NO.	SIZE	CTN/MSTR
A11011	1/8" x 1/8"	1/100
A11001	1/4" x 1/4"	100/200

Satin Brass Air Cock Male x Spigot Tee Handle HEX Shoulder



• Spring bottoms

PART NO.	SIZE	CTN/MSTR
A11002	1/4" x spigot	100/200

Satin Brass Air Cock Female x Male Tee Handle HEX Shoulder



• Spring bottoms

PART NO.	SIZE	CTN/MSTR
A11003	1/4" x 1/4"	1/200

Satin Brass Air Cock Female x Female Lever Handle Round Shoulder



• Spring bottoms

PART NO.	SIZE	CTN/MSTR
A11004	1/4" x 1/4"	1/100

Satin Brass Air Cock Female x Female Tee Handle HEX Shoulder



• Spring bottoms

PART NO.	SIZE	CTN/MSTR
A11005	1/4" x 1/4"	1/200

Satin Brass Air Cock Female x Female Tee Handle Round Shoulder



• Spring bottoms

PART NO.	SIZE	CTN/MSTR
A11016	1/8" x 1/8"	1/50
A11006	1/4" x 1/4"	100/200

Satin Brass Air Cock Female x Female Lever Handle HEX Shoulder



• Spring bottoms

PART NO.	SIZE	CTN/MSTR
A11017	1/8" x 1/8"	1/100
A11007	1/4" x 1/4"	1/100

Satin Brass Air Cock Female x Male Tee Handle Round Shoulder



• Spring bottoms

PART NO.	SIZE	CTN/MSTR
A11008	1/4" x 1/4"	100/200

Gas Ball Valve

- Forged brass body
- 3/8" x 3/4" one piece body
- 1"-2" two-piece body with plated steel handle
- Chrome plated brass ball
- Temperatures up to 175°F
- Threaded ends comply with ANSI B2.1
- CSA- certified for use with natural, manufactured, mixed, liquefied petroleum and LP gas/air mixtures up to 2 PSIG
- UL listed 757x (1/2" and 3/4")
- Made in Italy



Lever Handle, Female x Female



PART NO.	SIZE	CTN/MSTR
B64375	3/8" FIP	10/100
B64050	1/2" FIP	10/100
B64075	3/4" FIP	10/100
B64100	1" FIP	6/36
B64125	1-1/4" FIP	4/24
B64150	1-1/2" FIP	4/16
B64200	2" FIP	2/10

Tee Handle, Female x Female



PART NO.	SIZE	CTN/MSTR
B65375	3/8" FIP	10/100
B65050	3/8" FIP	10/100
B65075	3/4" FIP	10/100
B65100	1" FIP	6/36

Square Head, Female x Female



PART NO.	SIZE	CTN/MSTR
B66375	3/8" FIP	10/100
B66050	1/2" FIP	10/100
B66075	3/4" FIP	10/100

Two-Piece Gas Ball Valve

- Forged brass body
- Two-piece body
- Chrome plated brass ball
- Temperatures up to 125° F
- CSA- certified for use with natural, manufactured, mixed liquefied petroleum and L.P. gas/air mixtures up to 2 PSIG
- Made in Italy



PART NO.	SIZE	CTN/MSTR
B64450	1/2"	10/50
B64475	3/4"	10/50

Texas Pattern Gas Ball Valve

- One-piece forged body
- Lever handle
- Female IPS x hose end x 1/8" MIP
- CSA- certified for use with natural, manufactured, mixed liquefied petroleum and L.P. gas/air mixtures up to 2 PSIG
- Made in Italy



PART NO.	SIZE	CTN/MSTR
B69121	1/2" FIP x 1/8" MIP	10/100

Lever Handle Gas Ball Valve

- Forged brass body
- One piece body construction
- 3/4" Chrome plated forged brass ball
- Temperatures up to 175°F
- Threaded ends comply with ANSI B2.1
- CSA- certified for use with natural, manufactured, mixed, liquefied petroleum and LP gas/air mixtures up to 2 PSIG
- Made in Italy



Flare x Female



PART NO.	SIZE	CTN/MSTR
B67375	3/8" flare x 1/2" FIP	10/100
B67050	1/2" flare x 1/2" FIP	10/100
B67937	15/16" flare x 1/2" FIP	10/100
B67975	15/16" flare x 3/4" FIP	10/100

Flare x Male



PART NO.	SIZE	CTN/MSTR
B68001	1/2" flare x 1/2" MIP	10/100

Flare x Flare



PART NO.	SIZE	CTN/MSTR
B68375	3/8" flare x 3/8" flare	10/100
B68050	1/2" flare x 1/2" flare	10/100
B68058	5/8" flare x 5/8" flare	10/100

Gas Heater Valve

- Forged brass body
- One piece body construction
- Chrome plated forged brass ball
- Temperatures up to 175°F
- 9/16" - 24 Fine Thread Flare (for 3/8" tube)
- CSA certified for use with natural, manufactured, mixed, liquefied petroleum and LP gas/air mixtures up to 2 PSIG
- Made in Italy



PART NO.	SIZE	CTN/MSTR
B69050	9/16"-24 x 1/2" FIP	10/100

Brass Gas Ball Valve

- Two-piece forged brass body with chrome plated brass ball
- Double O-ring packing
- PTFE Seats
- 1/4 turn aluminum handle
- 1/2 PSI for indoor appliance connections per ANSI Z21.15/CGA 9.1
- Blowout-proof stem
- 5 PSI for indoor shutoff per CGA 91-002 & ASME B16.44
- CSA Listed



Female x Female		
PART NO.	SIZE	CTN/MSTR
B67100	1/2" FIP x 1/2" FIP	1/160
B67101	3/4" FIP x 3/4" FIP	1/100



Flare x Female		
PART NO.	SIZE	CTN/MSTR
B67102	3/8" FL x 1/2" FIP	1/160
B67103	1/2" FL x 1/2" FIP	1/160

Flare x Male		
PART NO.	SIZE	CTN/MSTR
B67104	1/2" FL x 1/2" MIP	1/160

Flare		
PART NO.	SIZE	CTN/MSTR
B67105	3/8" FL x 3/8" FL	1/160
B67106	1/2" FL x 1/2" FL	1/160

Brass Ball Valve

- Full-port design
- Forged brass body up to 4"
- Chrome plated brass ball
- Adjustable packing nut
- Non-sticking teflon seats
- 1/4 turn zinc plated steel handle
- 600 PSI, WOG (water, oil, gas)
- Working steam pressure: 150 PSI
- Blowout-proof stem
- Teflon packing for safety against leakage
- UPC Listed
- Lead Free



Threaded		
PART NO.	SIZE	CTN/MSTR
B67200	3/8"	20/100
B67201	1/2"	50/100
B67202	3/4"	30/60
B67203	1"	20/40
B67204	1-1/4"	12/24
B67205	1-1/2"	9/18
B67206	2"	6/12



Sweat		
PART NO.	SIZE	CTN/MSTR
B67208	1/2"	50/100
B67209	3/4"	30/60
B67210	1"	20/40
B67211	1-1/4"	12/24
B67212	1-1/2"	9/18
B67213	2"	6/12

Brass Ball and Waste Valve

- Full-port with waste design
- Forged brass body
- Chrome plated brass ball
- Adjustable packing nut
- Non-sticking teflon seats
- 1/4 turn zinc plated steel handle
- 600 PSI, WOG (water, oil, gas)
- Working steam pressure: 150 PSI
- Blowout-proof stem
- Teflon packing for safety against leakage
- NSF61 certified
- UPC Listed
- Lead Free



Sweat		
PART NO.	SIZE	CTN/MSTR
B67214	1/2"	10/60
B67215	3/4"	10/60
B67216	1"	5/40



Threaded		
PART NO.	SIZE	CTN/MSTR
B67217	1/2"	10/60
B67218	3/4"	10/60
B67219	1"	5/40

Brass Stop Valve

- Cast brass body
- Cast iron handle
- 125 PSI WOG to 100° F
- Maximum Temperature 180°F
- Lead Free



Threaded		
PART NO.	SIZE	CTN/MSTR
B67312	1/2"	6/48
B67313	3/4"	6/48



Stop & Waste Valve Threaded		
PART NO.	SIZE	CTN/MSTR
B67315	3/4"	10/100



Sweat		
PART NO.	SIZE	CTN/MSTR
B67316	1/2"	6/48
B67317	3/4"	10/100

Brass Broiler Drain Valve

- Forged brass body
- Copper or threads to hose
- Cast iron handle
- Non-sticking teflon seats
- 125 PSI WOG to 100°F
- Maximum Temperature 180°F
- UPC Listed



Male		
PART NO.	SIZE	CTN/MSTR
B67320	1/2" MIP x 3/4" MHT	10/100
B67321	3/4" MIP x 3/4" MHT	10/100

- Forged brass body
- Threads to hose
- Cast iron handle
- 125 PSI WOG to 100°F
- Maximum Temperature 180°F



Female		
PART NO.	SIZE	CTN/MSTR
B67322	1/2" FIP x 3/4" MHT	10/100
B67323	3/4" FIP x 3/4" MHT	10/100

PVC Ball Valve Solvent End

- One piece body construction
- Standard port
- EPDM seats and o-rings
- Working pressure 150 psi at 73°F
- Quarter turn operation
- Not for compressed air
- Ideal for swimming pools, irrigation and water supply uses
- Solvent ends comply with ASTM D 2466
- Threaded ends comply with ANSI B2.1
- For cold water lines
- Large flow opening



PART NO.	SIZE	CTN/MSTR
B90050	1/2"	1/162
B90075	3/4"	1/80
B90100	1"	1/84
B90125	1-1/4"	1/50
B90150	1-1/2"	1/50
B90200	2"	1/24
B90250	2-1/2"	1/15
B90300	3"	1/2
B90400	4"	1/1

PVC Ball Valve with Threaded Ends

- One-piece body construction
- Standard port
- EPDM seats and o-rings
- Working pressure 150 psi at 73°F
- Quarter turn operation
- Not for compressed air
- Ideal for swimming pools, irrigation and water supply uses
- Solvent ends comply with ASTM D 2466
- Threaded ends comply with ANSI B2.1
- For cold water lines
- Large flow opening



PART NO.	SIZE	CTN/MSTR
B91050	1/2"	1/162
B91075	3/4"	25/100
B91100	1"	1/84
B91125	1-1/4"	1/60
B91150	1-1/2"	1/40
B91200	2"	6/24
B91250	2-1/2"	1/16
B91300	3"	1/10
B91400	4"	1/1

CPVC Ball Valve

- Standard port
- For use on CPVC tubing size (OD)
- Teflon seats
- EPDM o-rings
- One piece body construction
- Large flow opening
- For hot or cold water lines up to 100 PSI at temperature up to 180°F
- Solvent ends comply with ASTM D2846
- Quarter turn operation
- NSF listed



PART NO.	SIZE	CTN/MSTR
B92050	1/2" (5/8" OD)	10/100
B92075	3/4" (7/8" OD)	10/100

Radiator Coin Key Air Valve and Key



- 1/8" threads
- 125 PSI
- CARTON QUANTITIES ONLY

PART NO.	DESCRIPTION	CTN/MSTR
R20001	Vent valve with key	50/500
R20002	Key only	100/5000
R20003	Valve only	100/1000

Angle Air Valve



- Use on radiators in room with thermostat or on radiators that effect the thermostat

PART NO.	DESCRIPTION	CTN/MSTR
R20104	#4 1/8"	12/144

- Use on radiators near the boiler and in warm room

PART NO.	DESCRIPTION	CTN/MSTR
R20105	#5 1/8"	12/144

- Use on radiators furthest from the boiler (i.e. 3rd floor)

PART NO.	DESCRIPTION	CTN/MSTR
R20107	#C 1/8"	12/144

- Use on radiators needing a lot of venting (i.e. long branches or extra long radiators)

PART NO.	DESCRIPTION	CTN/MSTR
R20108	#D 1/8"	12/144

Straight Air Valve



- Use on radiators furthest from the boiler (i.e. 3rd floor)

PART NO.	DESCRIPTION	CTN/MSTR
R20109	#C 1/8"	12/144

- Use on radiators needing a lot of venting (i.e. long branches or extra long radiators)

PART NO.	DESCRIPTION	CTN/MSTR
R20110	#D 1/8"	12/144

- Use on radiators furthest from the boiler (i.e. 3rd floor)

PART NO.	DESCRIPTION	CTN/MSTR
R20111	#C 1/4"	12/144

- Use on radiators needing a lot of venting (i.e. long branches or extra long radiators)

PART NO.	DESCRIPTION	CTN/MSTR
R20112	#D 1/4"	12/144

- Used at end of short main or main running to warm side of building

PART NO.	DESCRIPTION	CTN/MSTR
R20113	3/4" x 1/2"	12/144

Bronze Steam Radiator Angle Valve



PART NO.	DESCRIPTION	CTN/MSTR
R20005	1/2"	10/60
R20006	3/4"	6/48
R20007	1"	4/36
R20008	1-1/4"	2/24
R20009	1-1/2"	2/18

Items marked with the Jones Stephens logo are "You Need It... We Got It" Items.

Angle Steam Vent



• Use on one-pipe steam systems - at the radiator

PART NO.	DESCRIPTION	CTN/MSTR
R20100	1/8"	12/144

Straight Steam Vent



• Use on one-pipe steam systems - at the radiator

PART NO.	DESCRIPTION	CTN/MSTR
R20101	1/8"	12/144
R20102	1/4"	12/144

D

Radiator Angle Air Valve



PART NO.	DESCRIPTION	CTN/MSTR
R20150	1/8"	12/144
R20151	1/8" adjustable	12/144

Radiator Straight Air Valve



R20152
R20153

R20154

PART NO.	DESCRIPTION	CTN/MSTR
R20152	1/8"	12/144
R20153	1/8" adjustable	12/144
R20154	3/4" x 1/2"	12/144

3 Screw Radiator Valve Handle



• Fit-all

PART NO.	DESCRIPTION	CTN/MSTR
J40032	3 screw handle	25/500

4-N-1 Radiator Valve Handle



• Fit-all

PART NO.	DESCRIPTION	CTN/MSTR
J40033	4-n-1 handle	25/500

Single Union PVC Swimming Pool Valve



- Teflon seats
- 150 psi working pressure
- EPDM o-rings seal on union end
- Suitable for swimming pools, spas and plumbing
- Full port
- Solvent ends

PART NO.	SIZE	CTN/MSTR
B95150	1-1/2"	8/32
B95200	2"	5/20

Dual Check Backflow Preventer



- Female by female
- Forged brass body
- 150 psi
- Acetyl-resin check modules
- Stainless steel spring
- 180° F maximum temperature
- Lead Free

PART NO.	SIZE	CTN/MSTR
B59001LF	3/4"	1/100
B59002LF	1"	1/25

Inline PVC Check Valve



- Stainless steel spring
- EPDM seats
- Maintenance-free operation
- .5 psi required to open unit
- 200 psi static pressure rating at 77°F
- Use anywhere to stop backflow and siphoning
- Suitable for swimming pools, hot tubs, spas and solar installations

Solvent Ends

PART NO.	SIZE	CTN/MSTR
C30050	1/2"	30/120
C30075	3/4"	30/120
C30100	1"	16/64
C30125	1-1/4"	12/48
C30150	1-1/2"	8/32
C30200	2"	4/16

Threaded Ends

PART NO.	SIZE	CTN/MSTR
C31050	1/2"	30/120
C31075	3/4"	30/120
C31100	1"	16/64
C31125	1-1/4"	12/48
C31150	1-1/2"	8/32
C31200	2"	4/16

Forged Brass Hose Bibb



- Hard chrome ball
- Quarter-turn operation
- Teflon seats
- T-handle

PART NO.	SIZE	CTN/MSTR
B60950	1/2"	10/100
B60975	3/4"	10/100

Cast Brass Hose Bibb



- Lead Free

PART NO.	MIP x MALE HOSE	CTN/MSTR
B59050	1/2" x 3/4"	10/100
B59075	3/4" x 3/4"	10/100
B59100	1" x 1"	6/36

Economy Hose Bibb Vacuum Breaker



- Brass
- 3/4" hose thread
- Vandal-proof breakoff screw
- ASSE 1011

PART NO.	DESCRIPTION	CTN/MSTR
G04004	Economy	20/200
G04003LF	Economy - Lead Free	20/200

Hose Faucet Anchor



- Long lasting solution to loosen exterior faucets
- Works with any wall material (brick, concrete, vinyl siding or stucco)
- For repair or new home applications
- Fits all exterior or faucet water lines
- Corrosion free

PART NO.	DESCRIPTION	CTN/MSTR
B59000	Hose faucet anchor	1/100

Replacement Clamp For Flexible Coupling



- Made in USA
- CARTON QUANTITIES ONLY

MADE IN THE
USA

PART NO.	SIZE	CTN/MSTR
G15002	2"	10/200
G15003	3"	10/100
G15004	4"	10/100
G15006	6"	1/100
G15008	8"	1/50

Micro Size Gear Clamp

- 5/16" band
- Made in USA
- CARTON QUANTITIES ONLY

MADE IN THE
USA

Part Stainless



PART NO.	TRADE SIZE	SIZE	CTN/MSTR
G08004	4	1/4" - 5/8"	10/1000
G08006	6	5/16" - 7/8"	10/1000
G08008	8	3/8" - 1"	10/500
G08012	12	1/2" - 1-1/4"	10/500
G08016	16	1/2" - 1-1/2"	10/500
G08020	20	3/4" - 1-3/4"	10/500
G08024	24	1" - 2"	10/500

All Stainless



PART NO.	TRADE SIZE	SIZE	CTN/MSTR
G09004	4	1/4" - 5/8"	10/1000
G09006	6	5/16" - 7/8"	10/1000
G09008	8	1/2" - 1"	10/500
G09012	12	1/2" - 1-1/4"	10/500
G09016	16	1/2" - 1-1/2"	10/500
G09020	20	3/4" - 1-3/4"	10/500
G09024	24	1" - 2"	10/500

Full Size Gear Clamp

MADE IN THE
USA

- 1/2" band
- Made in USA
- CARTON QUANTITIES ONLY

Part Stainless



PART NO.	TRADE SIZE	SIZE	CTN/MSTR
G10006	6	3/8" - 7/8"	10/200
G10008	8	7/16" - 1"	10/200
G10010	10	1/2" - 1-1/16"	10/500
G10012	12	1/2" - 1-1/4"	10/500
G10016	16	3/4" - 1-1/2"	10/500
G10020	20	3/4" - 1-3/4"	10/500
G10024	24	1" - 2"	10/500
G10032	32	1-1/2" - 2-1/2"	10/500
G10036	36	7/8" - 2-3/4"	10/500
G10040	40	1-1/8" - 3"	10/200
G10052	52	1-7/8" - 3-3/4"	10/100
G10072	72	3-1/8" - 5"	10/100
G10080	80	3-5/8" - 5-1/2"	10/100
G10104	104	5" - 7"	10/100

All Stainless



PART NO.	TRADE SIZE	SIZE	CTN/MSTR
G11006	6	3/8" - 7/8"	10/200
G11008	8	7/16" - 1"	10/200
G11010	10	1/2" - 1-1/16"	10/500
G11012	12	1/2" - 1-1/4"	10/500
G11016 	16	11/16" - 1-1/2"	10/500
G11020	20	3/4" - 1-3/4"	10/500
G11024	24	1" - 2"	10/500
G11028	28	1-5/16" - 2-1/4"	10/500
G11032	32	1-9/16" - 2-1/2"	10/500
G11036	36	1-3/4" - 2-3/4"	10/500
G11040	40	1-1/8" - 3"	10/200
G11044	44	2-1/4" - 3 1/4"	10/200
G11048	48	1-5/8" - 3-1/2"	10/200
G11052	52	1-7/8" - 3-3/4"	10/200
G11056	56	2-1/8" - 4"	10/100
G11064	64	2-1/2" - 4-1/2"	10/100
G11072	72	3" - 5"	10/100
G11080	80	3-1/2" - 5-1/2"	10/100
G11088	88	4" - 6"	10/100
G11096	96	4-3/4" - 6-1/2"	10/100
G11104	104	5" - 7"	10/100

 Items marked with the Jones Stephens logo are "You Need It... We Got It" Items.

"68" Series Stainless Steel Gear Clamp

MADE IN THE
USA

- 9/16" band
- All stainless, 300 grade construction
- Ideal for well drilling and applications requiring marine grade stainless clamps
- Made in USA
- CARTON QUANTITIES ONLY



PART NO.	TRADE SIZE	SIZE	CTN/MSTR
G14006	6	3/8" - 7/8"	10/200
G14008	8	7/16" - 1"	10/200
G14010	10	1/2" - 1-1/16"	10/500
G14012	12	1/2" - 1-1/4"	10/500
G14016	16	11/16" - 1-1/2"	10/500
G14020	20	3/4" - 1-3/4"	10/500
G14024	24	1" - 2"	10/500
G14028	28	1-1/4" - 2-1/4"	10/500
G14032	32	1-1/2" - 2-1/2"	10/500
G14036	36	1-3/4" - 2-3/4"	10/200
G14040	40	1-1/8" - 3"	10/200
G14044	44	2-1/4" - 3-1/4"	10/200
G14048	48	1-5/8" - 3-1/2"	10/200
G14052	52	1-7/8" - 3-3/4"	10/100
G14056	56	2-1/8" - 4"	10/100
G14064	64	2-1/2" - 4-1/2"	10/100
G14072	72	3" - 5"	10/100
G14080	80	3-1/2" - 5-1/2"	10/100
G14088	88	4" - 6"	10/100
G14096	96	4-1/2" - 6-1/2"	10/100
G14104	104	5" - 7"	10/100

Stainless Steel Gear Clamp

- 9/16" band
- All stainless
- Hanging bag
- CARTON QUANTITIES ONLY



PART NO.	TRADE SIZE	SIZE	CTN/MSTR
G16006	6	3/8" - 7/8"	200/2000
G16008	8	7/16" - 1"	100/1000
G16010	10	1/2" - 1-1/16"	100/1000
G16012	12	1/2" - 1-1/4"	100/1000
G16016	16	11/16" - 1-1/2"	100/1000
G16020	20	3/4" - 1-3/4"	100/1000
G16024	24	1" - 2"	100/1000
G16028	28	1-1/4" - 2-1/4"	100/1000
G16032	32	1-1/2" - 2-1/2"	100/1000
G16036	36	1-3/4" - 2-3/4"	100/1000
G16040	40	1-1/8" - 3"	100/500
G16044	44	2-1/4" - 3-1/4"	100/500
G16048	48	1-5/8" - 3-1/2"	100/500
G16052	52	1-7/8" - 3-3/4"	100/500
G16056	56	2-1/8" - 4"	100/500
G16064	64	2-1/2" - 4-1/2"	100/500
G16072	72	3" - 5"	100/500
G16080	80	3-1/2" - 5-1/2"	50/250
G16088	88	4" - 6"	50/250
G16096	96	4-1/2" - 6-1/2"	50/250
G16104	104	5" - 7"	50/250

Asbestos-Free Full Face Gasket



- Meets ASTM F152, F36A and F146
- 1/16" thick
- Temperature rating of 750°F
- Manufactured of Garlock 4401

PART NO.	SIZE	LBS.	CTN/MSTR
G54075	3/4"	150	1/1
G54001	1"	150	1/1
G54013	1-1/4"	150	1/1
G54015	1-1/2"	150	1/1
G54002	2"	150	1/1
G54025	2-1/2"	150	1/1
G54003	3"	150	1/1
G54035	3-1/2"	150	1/1
G54004	4"	150	1/1
G54005	5"	150	1/1
G54006	6"	150	1/1
G54008	8"	150	1/1
G54010	10"	150	1/1
G54012	12"	150	1/1

Asbestos-Free Ring Gasket



- Meets ASTM F152, F36A and F146
- 1/16" thick
- Temperature rating of 750°F
- Manufactured of Garlock 4401

PART NO.	SIZE	LBS.	CTN/MSTR
G53050	1/2"	150	1/1
G53075	3/4"	150	1/1
G53001	1"	150	1/1
G53013	1-1/4"	150	1/1
G53015	1-1/2"	150	1/1
G53002	2"	150	1/1
G53025	2-1/2"	150	1/1
G53003	3"	150	1/1
G53035	3-1/2"	150	1/1
G53004	4"	150	1/1
G53005	5"	150	1/1
G53006	6"	150	1/1
G53008	8"	150	1/1
G53010	10"	150	1/1
G53012	12"	150	1/1

Red Rubber Full Face Gasket



- Meets ASTM D1330
- 1/16" thick
- Temperature rating of 350° F

PART NO.	SIZE	LBS.	CTN/MSTR
G51050	1/2"	150	1/1
G51075	3/4"	150	1/1
G51001	1"	150	1/1
G51013	1-1/4"	150	1/1
G51015	1-1/2"	150	1/1
G51002	2"	150	1/1
G51025	2-1/2"	150	1/1
G51003	3"	150	1/1
G51035	3-1/2"	150	1/1
G51004	4"	150	1/1
G51005	5"	150	1/1
G51006	6"	150	1/1
G51008	8"	150	1/1
G51010	10"	150	1/1
G51012	12"	150	1/1

Red Rubber Ring Gasket



- Meets ASTM D1330
- 1/16" thick
- Temperature rating of 350° F

PART NO.	SIZE	LBS.	CTN/MSTR
G52075	3/4"	150	1/1
G52001	1"	150	1/1
G52013	1-1/4"	150	1/1
G52015	1-1/2"	150	1/1
G52002	2"	150	1/1
G52025	2-1/2"	150	1/1
G52003	3"	150	1/1
G52035	3-1/2"	150	1/1
G52004	4"	150	1/1
G52005	5"	150	1/1
G52006	6"	150	1/1
G52008	8"	150	1/1
G52010	10"	150	1/1
G52012	12"	150	1/1

Asbestos-Free Full Face Gasket Kit



- Meets ASTM F152, F36A and F146
- Gaskets are 1/16" thick
- ASTM A307 hex bolts and heavy hex nuts
- Constructed of Garlock 4401

PART NO.	PIPE SIZE	BOLT SIZE	BOLTS/KIT	CTN/MSTR
G54115	1-1/2"	1/2" x 2-1/4"	4	1/1
G54102	2"	5/8" x 2-3/4"	4	1/1
G54125	2-1/2"	5/8" x 3"	4	1/1
G54103	3"	5/8" x 3"	4	1/1
G54104	4"	5/8" x 3"	8	1/1
G54105	5"	3/4" x 3-1/4"	8	1/1
G54106	6"	3/4" x 3-1/4"	8	1/1
G54108	8"	3/4" x 3-1/2"	8	1/1
G54110	10"	7/8" x 3-3/4"	12	1/1
G54112	12"	7/8" x 4"	12	1/1

Asbestos-Free Ring Gasket Kit



- Meets ASTM F152, F36A and F146
- Gaskets are 1/16" thick
- ASTM A307 hex bolts and heavy hex nuts
- Constructed of Garlock 4401

PART NO.	PIPE SIZE	BOLT SIZE	BOLTS/KIT	CTN/MSTR
G53101	1"	1/2" x 2"	4	1/1
G53113	1-1/4"	1/2" x 2-1/4"	4	1/1
G53115	1-1/2"	1/2" x 2-1/4"	4	1/1
G53102	2"	5/8" x 2-3/4"	4	1/1
G53125	2-1/2"	5/8" x 3"	4	1/1
G53103	3"	5/8" x 3"	4	1/1
G53104	4"	5/8" x 3"	8	1/1
G53105	5"	3/4" x 3-1/4"	8	1/1
G53106	6"	3/4" x 3-1/4"	8	1/1
G53108	8"	3/4" x 3-1/2"	8	1/1
G53110	10"	7/8" x 3-3/4"	12	1/1

Red Rubber Full Face Gasket Kit



- Meets ASTM D1330
- Gaskets are 1/16" thick
- ASTM A307 hex bolts and heavy hex nuts

PART NO.	PIPE SIZE	BOLT SIZE	BOLTS/KIT	CTN/MSTR
G51102	2"	5/8" x 2-3/4"	4	1/1
G51125	2-1/2"	5/8" x 3"	4	1/1
G51103	3"	5/8" x 3"	4	1/1
G51135	3-1/2"	5/8" x 3"	8	1/1
G51104	4"	5/8" x 3"	8	1/1
G51105	5"	3/4" x 3-1/4"	8	1/1
G51106	6"	3/4" x 3-1/4"	8	1/1
G51108	8"	3/4" x 3-1/2"	8	1/1
G51110	10"	7/8" x 3-3/4"	12	1/1
G51112	12"	7/8" x 4"	12	1/1

D Red Rubber Ring Gasket Kit



- Meets ASTM D1330
- Gaskets are 1/16" thick
- ASTM A307 hex bolts and heavy hex nuts

PART NO.	PIPE SIZE	BOLT SIZE	BOLTS/KIT	CTN/MSTR
G52115	1-1/2"	1/2" x 2-1/4"	4	1/1
G52102	2"	5/8" x 2-3/4"	4	1/1
G52125	2-1/2"	5/8" x 3"	4	1/1
G52103	3"	5/8" x 3"	4	1/1
G52104	4"	5/8" x 3"	8	1/1
G52105	5"	3/4" x 3-1/4"	8	1/1
G52106	6"	3/4" x 3-1/4"	8	1/1
G52108	8"	3/4" x 3-1/2"	8	1/1
G52110	10"	7/8" x 3-3/4"	12	1/1

Insulation Kit with Poly Sleeves



- Use with flange connection kits
- To form dielectric connection use fiber washers

PART NO.	SIZE	#SLEEVES	#WASHERS	CTN/MSTR
G55150	1-1/2"	4	8	1/1
G55200	2"	4	8	1/1
G55250	2-1/2"	4	8	1/1
G55300	3"	4	8	1/1
G55350	4"	8	16	1/1
G55400	5"	8	16	1/1
G55450	6"	8	16	1/1
G55500	8"	8	16	1/1
G55550	10"	12	24	1/1
G55600	12"	12	24	1/1

Asbestos-Free Ring Gasket Kit with Insulation Kit



PART NO.	PIPE SIZE	BOLT SIZE	BOLTS/KIT	CTN/MSTR
G53203	3"	5/8" x 3"	4	1/1
G53204	4"	5/8" x 3"	8	1/1
G53206	6"	3/4" x 3-1/4"	8	1/1
G53215	1-1/2"	1/2" x 2-1/4"	4	1/1
G53225	2-1/2"	5/8" x 3"	4	1/1

Asbestos-Free Full Face Gasket Kit with Insulation Kit



PART NO.	PIPE SIZE	BOLT SIZE	BOLTS/KIT	CTN/MSTR
G54215	1-1/2"	1/2" x 2-1/4"	4	1/1
G54202	2"	5/8" x 2-3/4"	4	1/1
G54225	2-1/2"	5/8" x 3"	4	1/1
G54203	3"	5/8" x 3"	4	1/1
G54204	4"	5/8" x 3"	8	1/1
G54205	5"	3/4" x 3-1/4"	8	1/1
G54206	6"	3/4" x 3-1/4"	8	1/1
G54208	8"	3/4" x 3-1/2"	8	1/1
G54210	10"	7/8" x 3-3/4"	12	1/1
G54212	12"	7/8" x 4"	12	1/1

Red Rubber Sheet Packing/Gasket Material



- Priced per roll (approximately 100 pounds)
- FULL ROLLS ONLY

PART NO.	DESCRIPTION	CTN/MSTR
G55016	1/16" x 36" x 60'	1/1
G55018	1/8" x 36" x 30'	1/1
G55014	1/4" x 36" x 15'	1/1

Red Rubber Sheet Packing/Gasket Material



- Single 3' x 5' sheet

PART NO.	MATERIAL	THICKNESS	CTN/MSTR
G55116	Red Rubber (1 sheet)	1/16"	1/1
G55118	Red Rubber (1 sheet)	1/8"	1/1

Gasket and Washer Materials



- Make your own gaskets and washers
- 6" x 6" square in hanging display bag

PART NO.	MATERIAL	THICKNESS	CTN/MSTR
G55001	Red Rubber (1 sheet)	1/16"	1/1
G55002	Black Fiber (1 sheet)	1/32"	1/1
G55003	Cork/Rubber (1 sheet)	1/16"	1/1
G55004	Combo (1 sheet of each)	—	1/1

Circulator Flange Gasket Pair



- SOLD IN PAIRS ONLY

PART NO.	DESCRIPTION	CTN/MSTR
G55005	Circulator flange gasket	1/1

Water Hammer Arresters

- Maximum working temp: 250°F
- Maximum working pressure: 300psi
- Burst pressure: 2900psi
- Poly Bagged
- UPC Listed
- Lead Free



FIXTURE	TYPE OF SUPPLY CONTROL	PUBLIC			PRIVATE		
		TOTAL	C.W.	H.W.	TOTAL	C.W.	H.W.
Water Closet	Flush Valve	10	10	--	6	6	--
Water Closet	Flush Tank	5	5	--	3	3	--
Pedestal Urinal	Flush Valve	10	10	--	--	--	--
Stall or Wall Unit	Flush Valve	5	5	--	--	--	--
Stall or Wall Unit	Flush Tank	3	3	--	--	--	1
Lavatory	Faucet	2	1-1/2	1-1/2	1	1	1-1/2
Bath tub	Faucet	4	2	3	2	1-1/2	1-1/2
Shower Head	Mixing Valve	4	2	3	2	1	2
Bathroom Group	Flush Valve Closet	--	--	--	8	8	3
Bathroom Group	Flush Tank Closet	--	--	--	6	6	3
Separate Shower	Mixing Valve	--	--	--	2	1	2
Service Sink	Faucet	3	3	3	--	--	--
Laundry Tubs (3)	Faucet	--	--	--	3	3	3
Combination Fixture	Faucet	--	--	--	3	3	3

Now apply the total fixture units to Table B to obtain your PDI size value.

PDI SIZE ARRESTER:	AA	A	B	C	D	E	F
FIXTURE UNITS:	1-5	1-11	12-32	33-60	61-113	114-154	155-330
THREAD SIZE:	1/2	1/2	3/4	3/4	1	1	1
CATALOG NUMBER:	ALL A97 SERIES						

MIP AA



PART NO.	SIZE	CTN/MSTR
A97001	1/2"	1/1

MSWT AA



PART NO.	SIZE	CTN/MSTR
A97002	1/2"	1/1

CPVC AA



PART NO.	SIZE	CTN/MSTR
A97004	1/2"	1/1

PEX TEE AA



PART NO.	SIZE	CTN/MSTR
A97007	1/2"	1/1

OD TEE AA



PART NO.	SIZE	CTN/MSTR
A97009	3/8"	1/1















MHT x FHS AA



PART NO.	SIZE	CTN/MSTR
A97011	3/4"	1/1



COMMERCIAL & RESIDENTIAL PLASTICS

Closet Flanges and Accessories	180-184	
Residential Drains	185-188	
LevelBest Drainage and Cleanout System.....	189-190	
Commercial Drains.....	191-216	
Commercial Pipe/Hub Fit Adapter Drains.....	191-197	
8-1/2" Pan Commercial Drains.....	198-204	
8-1/2" Commercial Slab Drains.....	205-211	
10" Pan Heavy Duty Commercial Drains	212-216	
Commercial Drain Bases.....	217-218	
Commercial Spuds and Strainers.....	219-222	
General Purpose/Utility Drains.....	223-227	
Inside Pipe Fit Drains and Cleanouts	228	
Residential and Light Commercial Cleanouts.....	229-231	
Commercial Cleanouts.....	232-235	
Cleanout Spuds.....	236-237	
Floor Sinks and Accessories	238-239	
Backwater Valves and Accessories.....	240-241	
Roof Drains.....	242	

E

*Published March 2017. List prices can be found in list price book and on our website.

Plastic components are proudly made in the United States.
Final assembly is completed in our Operational Center
of Excellence in Moody, Alabama.

JONES STEPHENS RESIDENTIAL SHOWER DRAINS

The very definition of versatility.



FLEXIBLE
FITS 95% OF ALL SNAP-IN
OR SCREW-IN STRAINERS
ON THE MARKET

MODIFIED
2" GRAY PVC SPUD
HELPS CAMOUFLAGE
DIRT & SOAP SCUM

ADJUSTABLE
REVERSING CLAMPING
RING WHEN ADDITIONAL
HEIGHT IS NEEDED

ADAPTABLE
ENDLESS OPTIONS FOR ALL TYPES OF APPLICATIONS

D50001 The ultimate drain solution.



STYLE

Choose from cast or stamped, round or square, screw-in or snap-in.*

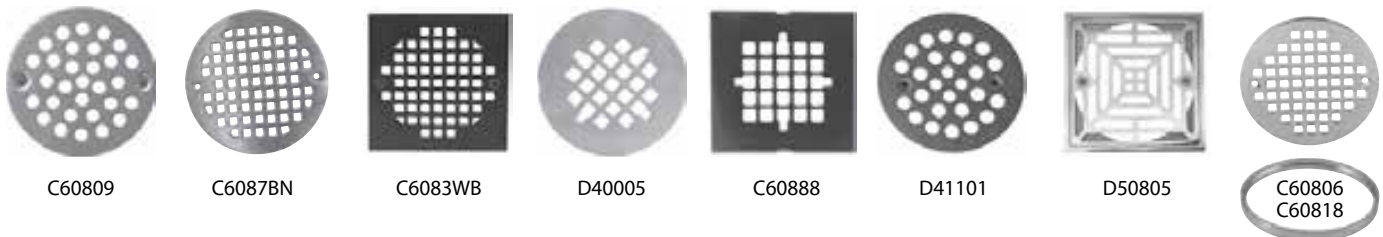

C60809

C6087BN

C6083WB

D40005

C60888

D41101

D50805

C60806
C60818

TYPE

Choose from metal or plastic spud with strainer.*



D50980

D60981

D60989

D60942

FINISH

Choose from several finishes to complete the look.

Chrome Plated, Brushed Nickel, Oil Rubbed Bronze,
Old World Bronze, Pearl Nickel, Polished Brass (PVD),
Polished Stainless

*All models have additional finishes available. See Section E in JS Catalog.



3x more options than the competition!

All residential shower drains can be found in Sections E & F in JS Catalog.

Additional Features of the D50001

- Low profile for first and second floor installations
- Beveled edge allows for recessed installation
- Reversible clamping ring for additional 1/2" height adjustment
- Brass inserts ensure secure clamping of membrane
- Dual weeps holes allow secondary drainage from the shower to prevent mold and mildew
- Recessed sump area for added drainage
- Use D50998 or D60978 tailpiece extension when additional height is needed



JONES STEPHENS DRAINS

Flexible. Adjustable. Adaptable.



Ask us to complete a cross reference for you today!

Contact your local Jones Stephens sales representative to order today!



Adjust height BEFORE & AFTER concrete pour!

LevelBest

PVC Rough-In Adapter

used for Cast Iron or PVC Drains & Cleanouts

- LevelBest can be used with most manufacturers' products! Industry Standard iron pipe size threads compatible with most adapter and drain bodies.
- LevelBest is the only product on the market that is compatible with most plastic and brass spuds used in the industry.
- LevelBest is the only product that includes the spacer ring that can be used with brass spuds.
- PVC, ABS or CAST IRON drains and cleanouts are compatible with LevelBest.
- LevelBest can be used with tile rings.



Removable Cap -
Remove after concrete is poured

Optional Spacer -
Included for brass spuds

LevelBest PVC Rough-in Adapter -
Allows adjustment to floor level after concrete is poured

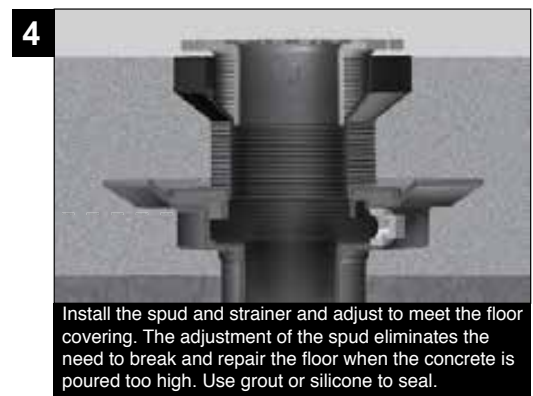
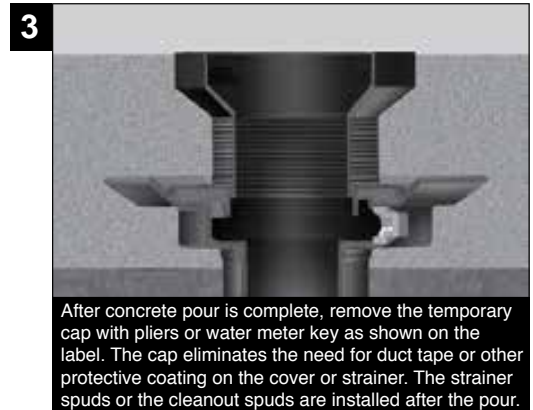
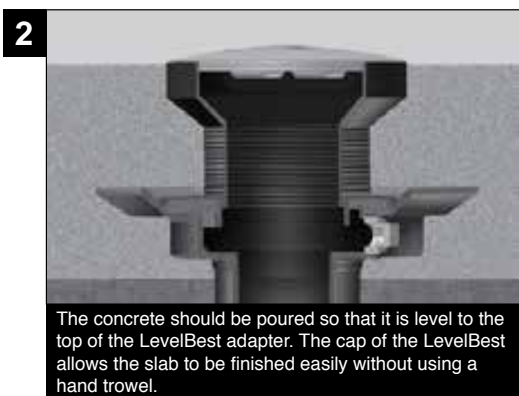
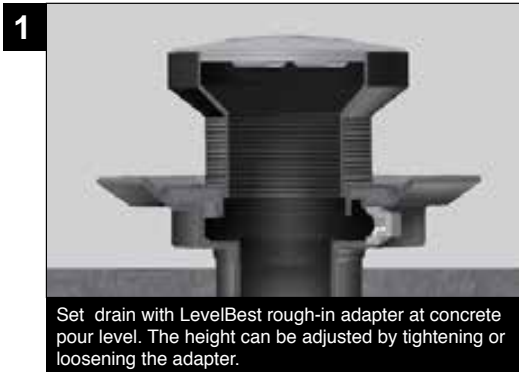

Plumbfit Closet Flange

3" Fits Inside 3" Schedule 40 DWV Pipe
3" x 4" Fits Flush with Floor



- Long shank
- 6 screw holes
- Extra-thick flange with short slots for extra strength
- For 3" units cut pipe 1/8" below floor and remove concrete so unit will fit flush
- 3" has 4 closet bolt slots



PVC		
PART NO.	DESCRIPTION	CTN/MSTR
C51300	3" less knockout	1/20
C50300	3" with knockout	1/20
C51340	3" x 4" less knockout	1/20
C50340	3" x 4" with knockout	1/20

ABS		
PART NO.	DESCRIPTION	CTN/MSTR
C51301	3" less knockout	1/20
C50301	3" with knockout	1/20
C51341	3" x 4" less knockout	1/20
C50341	3" x 4" with knockout	1/20

Plumbfit Closet Flange

Fits Over 4" Schedule 40 DWV Pipe



- Long shank
- 6 screw holes
- Extra thick flange with short slots for extra strength



PVC		
PART NO.	DESCRIPTION	CTN/MSTR
C51400	4" less knockout	1/20
C50400	4" with knockout	1/20

ABS		
PART NO.	DESCRIPTION	CTN/MSTR
C51401	4" less knockout	1/20

Plumbfit Closet Flange with Metal Ring

3" x 4" Fits Over 3" or Inside 4" Schedule 40 DWV Pipe
4" Fits Over 4" Schedule 40 DWV Pipe



- Adjustable metal ring
- 6 screw holes
- 2 radial slots for closet bolts



PVC		
PART NO.	DESCRIPTION	CTN/MSTR
C53340	3" x 4" less knockout	1/20
C52340	3" x 4" with knockout	1/20
C53400	4" less knockout	1/20
C52400	4" with knockout	1/20

ABS		
PART NO.	DESCRIPTION	CTN/MSTR
C53341	3" x 4" less knockout	1/20
C52341	3" x 4" with knockout	1/20
C53401	4" less knockout	1/20
C52401	4" with knockout	1/20

Plumbfit Closet Flange with Stainless Steel Ring

3" Fits Inside 3" Schedule 40 DWV Pipe
3" x 4" Fits Over 3" or Inside 4" Schedule 40 DWV Pipe
4" Fits Over 4" Schedule 40 DWV Pipe



- Exclusive 400 grade stainless with plumb fit bodies
- Radial slots for closet bolts; 6 screw holes
- For Schedule 40 DWV pipe



PVC		
PART NO.	DESCRIPTION	CTN/MSTR
C57234	3" less knockout; 4" long shank	1/20
C57236	3" less knockout; 6" long shank	1/20
C57134	3" x 4" less knockout	1/20
C57034	3" x 4" with knockout	1/20
C57334	3" x 4" less knockout; 6" long shank	1/20
C57040	4" with knockout	1/20
C57140	4" less knockout	1/20

ABS		
PART NO.	DESCRIPTION	CTN/MSTR
C58234	3" less knockout; 4" long shank	1/20
C58236	3" less knockout; 6" long shank	1/20
C58134	3" x 4" less knockout	1/20
C58034	3" x 4" with knockout	1/20
C58334	3" x 4" less knockout; 6" long shank	1/20
C58040	4" with knockout	1/20
C58140	4" less knockout	1/20

Closet Flange with Knockout

Fits Over 3" or Inside 4" Schedule 40 DWV Pipe



- Easy to remove knockout comes out in one piece
- 6 screw holes
- 2 radial slots for closet bolts
- Fits flush with floor
- Boxed
- UPC listed



PVC		
PART NO.	DESCRIPTION	CTN/MSTR
C50345	3" x 4" with knockout	1/25

ABS		
PART NO.	DESCRIPTION	CTN/MSTR
C50346	3" x 4" with knockout	1/25

Closet Flange with Metal Ring and Knockout

Fits Over 3" or Inside 4" Schedule 40 DWV Pipe



- Easy to remove knockout comes out in one piece
- 6 screw holes
- 2 radial slots for closet bolts
- Fits flush with floor
- Boxed
- UPC listed



PVC		
PART NO.	DESCRIPTION	CTN/MSTR
C52345	3" x 4" with knockout	1/25

ABS		
PART NO.	DESCRIPTION	CTN/MSTR
C52346	3" x 4" with knockout	1/25

Items marked with the Jones Stephens logo are "You Need It... We Got It" Items.

Closest Flange with Stainless Steel Ring and Knockout

Fits Over 3" or Inside 4" Schedule 40 DWV Pipe



- Easy to remove knockout comes out in one piece
- 6 screw holes
- 2 radial slots for closet bolts
- Fits flush with floor
- Boxed
- UPC listed



PVC

PART NO.	DESCRIPTION	CTN/MSTR
C57045	3" x 4" with knockout	1/25

ABS

PART NO.	DESCRIPTION	CTN/MSTR
C58045	3" x 4" with knockout	1/25

Spigot Fit Closet Flange



- Extra-thick flange with short slots for extra strength
- 6 screw holes
- Flush fit



PVC

PART NO.	DESCRIPTION	CTN/MSTR
C51350	3" less knockout	1/20
C51450	4" less knockout	1/20

ABS

PART NO.	DESCRIPTION	CTN/MSTR
C51351	3" less knockout	1/20
C51451	4" less knockout	1/20

Plumbfit Closet Flange with Adjustable Ring

Fits Over 3" and Inside 4" Schedule 40 DWV Pipe



- 6" long shank
- Can be cut to desired length
- Swivel rings



PVC

PART NO.	DESCRIPTION	CTN/MSTR
C53600	3" x 4" with metal ring	1/10
C53700	3" x 4" with plastic ring	1/10

ABS

PART NO.	DESCRIPTION	CTN/MSTR
C53601	3" x 4" with metal ring	1/10
C53701	3" x 4" with plastic ring	1/10

3" Closet Flange with Adjustable Ring

Fits Inside 3" Schedule 40 DWV



- Adjustable swivel rings
- Flush fit

PVC

PART NO.	DESCRIPTION	BARREL SIZE	CTN/MSTR
C50302	3" with metal ring	4"	1/10
C50306	3" with plastic ring	4"	1/10
C50304	3" with metal ring	6"	1/10
C50308	3" with plastic ring	6"	1/10

ABS

PART NO.	DESCRIPTION	BARREL SIZE	CTN/MSTR
C50303	3" with metal ring	4"	1/10
C50307	3" with plastic ring	4"	1/10
C50305	3" with metal ring	6"	1/10
C50309	3" with plastic ring	6"	1/10

Plastic Two Finger Flange



- Fits flush
- Patent #: 5,937,450
- Will fit oblong horns
- Pushes easily into 3" or 4" cast iron or Schedule 40 DWV pipe
- ASTM C-564 rubber gasket



NSF

White Plastic

PART NO.	DESCRIPTION	CTN/MSTR
C4733P	3" x 3"	1/6
C4743P	4" x 3"	1/6

Black Plastic

PART NO.	DESCRIPTION	CTN/MSTR
C4733A	3" x 3"	1/6
C4743A	4" x 3"	1/6

Closest Flange with 3-1/2" Extended Threads



PVC

PART NO.	DESCRIPTION	CTN/MSTR
C54150	with 3-1/2" extended threads	1/20

Items marked with the Jones Stephens logo are "You Need It... We Got It" Items.

Plumbfit Closet Flange with Plastic Swivel Ring

3" x 4" Fits Over 3" or Inside 4" Schedule 40 DWV Pipe
4" Fits Over Schedule 40 DWV Pipe



- Plastic ring will not deteriorate
- 360° rotation
- 2 radial slots and 2 grooved slots for closet bolts
- 6 screw holes for securing to floor



PVC		
PART NO.	DESCRIPTION	CTN/MSTR
C53342	3" x 4" less knockout	1/20
C54402	3" x 4" offset less knockout	1/20
C52342	3" x 4" with knockout	1/6
C52402	4" with knockout	1/10
C53402	4" less knockout	1/10

ABS		
PART NO.	DESCRIPTION	CTN/MSTR
C53343	3" x 4" less knockout	1/20
C54403	3" x 4" offset less knockout	1/20
C52343	3" x 4" with knockout	1/20
C52403	4" with knockout	1/10
C53403	4" less knockout	1/10

45° Closet Flange

Fits Over 3" DWV with a 4" Sweep



- CSA certified
- With plastic swivel ring
- More versatile than an offset closet flange
- Provides unlimited offset when used in conjunction with a socket x socket 45° elbow



PVC		
PART NO.	DESCRIPTION	CTN/MSTR
C55043	3" x 4" with plastic ring	1/20

ABS		
PART NO.	DESCRIPTION	CTN/MSTR
C55143	3" x 4" with plastic ring	1/20

Offset Plumbfit Closet Flange with Stainless Steel Ring

Fits Over 3" or Inside 4" Schedule 40 DWV Pipe



- Exclusive 400 grade stainless with plumbfit bodies
- Radial slots for closet bolts; 6 screw holes
- 2" offset



PVC		
PART NO.	DESCRIPTION	CTN/MSTR
C57434	3" x 4" offset less knockout	1/20

ABS		
PART NO.	DESCRIPTION	CTN/MSTR
C58434	3" x 4" offset less knockout	1/20

Offset Closet Flange

Fits Over 3" or Inside 4" Schedule 40 DWV Pipe



- 2" offset
- 4 closet bolt slots and 2 mounting screw holes



PVC		
PART NO.	DESCRIPTION	CTN/MSTR
C54340	3" x 4" offset less knockout	1/20

ABS		
PART NO.	DESCRIPTION	CTN/MSTR
C54341	3" x 4" offset less knockout	1/20

Offset Closet Flange with Metal Ring

Fits Over 3" or Inside 4" Schedule 40 DWV Pipe



- 2" offset
- Adjustable metal ring
- 2 radial slots for closet bolts



PVC		
PART NO.	DESCRIPTION	CTN/MSTR
C54400	3" x 4" offset less knockout	1/20

ABS		
PART NO.	DESCRIPTION	CTN/MSTR
C54401	3" x 4" offset less knockout	1/20

4-Way Offset Closet Flange

Fits Over 3" or Inside 4" Schedule 40 DWV Pipe



- 2" offset
- 1-13/16" barrel depth



PVC		
PART NO.	DESCRIPTION	CTN/MSTR
C54342	3" x 4" offset less knockout	1/20

ABS		
PART NO.	DESCRIPTION	CTN/MSTR
C54343	3" x 4" offset less knockout	1/20

3" Over Schedule 30 Pipe Closet Flange



PVC		
PART NO.	DESCRIPTION	CTN/MSTR
C51150	3" less knockout	1/20
C52150	3" with knockout	1/20

Adjustable Urinal Flange Kit

Spigot Fits Inside Hub of Fitting
Socket Fits Over 2" Schedule 40 DWV Pipe



- 3-1/4" - 7" flange mounting centers
- Kits include bolts, nuts, washers and gasket

PVC

PART NO.	DESCRIPTION	CTN/MSTR
F10001	2" spigot outlet	1/20
F10002	2" socket/hub outlet	1/20

ABS

PART NO.	DESCRIPTION	CTN/MSTR
F11001	2" spigot outlet	1/20
F11002	2" socket/hub outlet	1/20

Radial Fit Urinal Flange Kit



- Permits parallel alignment using radial slots
- Adjusts to 4" to 6" centers
- Socket and spigot connections
- Kit includes bolts, nuts, washers and gasket

PVC

PART NO.	DESCRIPTION	CTN/MSTR
F10003	2" with socket connection	1/1
F10004	2" with spigot connection	1/1

ABS

PART NO.	DESCRIPTION	CTN/MSTR
F11003	2" with socket connection	1/1
F11004	2" with spigot connection	1/1

Closet Flange Extender



- Stackable to desired height
- For raising floor height when adding ceramic tile or hardwood

MADE IN THE USA

PVC

PART NO.	DESCRIPTION	CTN/MSTR
C88001	1/2" thick	1/20
C88501	1/4" thick	1/20

Waxless Gasket



- Reusable
- Seals closet flange without using wax

MADE IN THE USA

PART NO.	DESCRIPTION	CTN/MSTR
C88002	Waxless gasket	1/1

Items marked with the Jones Stephens logo are "You Need It...We Got It" Items.

Closet Flange Ring



- Fits over 3" or 4" PVC
- Converts 3" and 4" PVC pipe into a toilet ready application

MADE IN THE USA

PVC

PART NO.	DESCRIPTION	CTN/MSTR
C51302	3" ring	1/10
C51402	4" ring	1/10

ABS

PART NO.	DESCRIPTION	CTN/MSTR
C51303	3" ring	1/10
C51403	4" ring	1/10

Closet Flange Repair Ring



- Securely attaches to concrete or wood sub-floor
- Replaces most closet rings
- Corrosion resistant
- Mounting ears offset by 1/8" to allow closet bolts to be installed

PART NO.	DESCRIPTION	CTN/MSTR
C85000	Closet flange repair ring	20/80

Closet Flange Spacer Kit



- Reusable toilet seal gasket
- For repair or correction of problems resulting from installation errors or remodeling projects
- Complete kit includes: 2 gaskets, 1/2" spacer, 1/4" x 3-1/2" closet bolt kit, 2 plastic shims

MADE IN THE USA

PART NO.	DESCRIPTION	CTN/MSTR
C88600	Spacer kit	1/10

Complete Closet Flange Extension Kit with Gaskets



- Useful when overlaying, replacing or tiling bathroom floors
- Two 3-1/2" closet bolts with washers and nuts
- Anchors toilet bolts when closet ring is broken
- No caulking required
- Has built-in gaskets
- One 1/4" flange & one 1/2" flange

MADE IN THE USA

PART NO.	DESCRIPTION	CTN/MSTR
C88500	Complete kit	1/10
C88502	Kit less bolts	1/10

Complete Closet Flange Extension Kit with Caulk



MADE IN THE
USA

- Three 1/4" extenders for easy adjustment
- Two 3-1/2" closet bolts with washers and nuts
- Adhesive caulk and all hardware included

PART NO.	DESCRIPTION	CTN/MSTR
C88500C	Complete kit	1/10

Closet Flange Extension Kit



MADE IN THE
USA

- No mastic necessary between pieces as with stackable units
- Heavy solid plastic construction
- Two 3-1/2" closet bolts with washers and nuts
- Packaged in display header bag
- One 1/2" flange

PART NO.	DESCRIPTION	CTN/MSTR
C88050	1/2" extension kit	1/10

Gapper Flange



- Used to repair broken closet flanges
- Individually carded for easy display or bulk

PART NO.	DESCRIPTION	CTN/MSTR
C87100	Repair flange	24/240

Flexible and Rigid Super Shims



MADE IN THE
USA

- Stackable
- Rigid, can be driven
- Flexible, can be trimmed
- 10 per bag
- Priced per bag

PART NO.	DESCRIPTION	CTN/MSTR
S55950	1-1/8" x 1-15/16" x 1/4" flexible	10/400
S55951	1-1/8" x 1-15/16" x 1/4" rigid	10/400

Flexible Super Shims



MADE IN THE
USA

- 200 Flexible super shims packaged in a convenient refillable "candy bowl" counter display
- Priced per display

PART NO.	DESCRIPTION	CTN/MSTR
S55952	200 Flexible super shims	200/200

Rigid Super Shims

MADE IN THE
USA



- 200 Rigid super shims packaged in a convenient refillable "candy bowl" counter display
- Priced per display

PART NO.	DESCRIPTION	CTN/MSTR
S55953	200 Rigid super shims	200/200

Closet Wedge Shims



MADE IN THE
USA

- Stackable
- 3/8" width x 1-3/8" length x 5/16" height
- Easily trimmed to desired height
- 100 per bag
- Priced per bag or display

PART NO.	DESCRIPTION	CTN/MSTR
S55902	100 shims poly bagged	100/100
S55903	1000 shims counter display	1000/1000

Items marked with the Jones Stephens logo are "You Need It... We Got It" Items.

PVC and ABS Residential Shower/Floor Drains

Pages 185-188

SIZES: 2", 2"x 3"



For use in
residential applications.

2" x 3" Shower/Floor Drain

Fits Over 2" or Inside 3" Schedule 40 DWV Pipe

MADE IN THE
USA



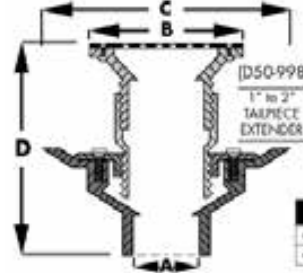

- Low profile for first and second floor installations
- Beveled edge allows for recessed installation
- Reversible clamping ring for additional 1/2" height adjustment
- Brass inserts ensure secure clamping of membrane
- Dual weeps holes
- Recessed sump area for added drainage
- D50001 UPC Listed



• Use **D50998** Tailpiece Extension (listed below) when additional height is needed.

	A	B	C	D
Over 2" pipe	4-1/4"	6-1/2"	3-1/4" - 4-3/8"	
Over 3" pipe	4-1/4"	6-1/2"	3-1/4" - 4-3/8"	

PVC

PART NO.	STRAINER	REPL. STRAINER	CTN/MSTR
D50001 	4" SS	C60809	1/20
D50002	4" PB	C60810	1/20
D50132	4" PB cast	C60807	1/20
D50133	4" PB cast w/ring	C60807/C60824	1/20
D50130	4" NB cast	C60808	1/20
D50131	4" NB cast w/ring	C60808/C60825	1/20
D50011	4" CP cast	C60806	1/20
D50010	4" CP cast w/ring	C60806/C60818	1/20
D50134 	4" CP cast square	C60812	1/20
D50135	4" PB cast square	C60813	1/20
D50120	PT and 4" SS	C60809	1/1
D50121	PT and 4" PB	C60810	1/1
D50122	PT and 4" PB cast	C60807	1/1
D50123	PT and 4" CP cast	C60806	1/1
D50124	4" CP cast	C60808	1/1

ABS

PART NO.	STRAINER	REPL. STRAINER	CTN/MSTR
D50301	4" SS	C60809	1/20
D50302	4" PB	C60810	1/20
D50332	4" PB cast	C60807	1/20
D50333	4" PB cast w/ring	C60807/C60824	1/20
D50330	24" NB cast	C60808	1/20
D50331	4" NB cast w/ring	C60808/C60825	1/20
D50311	4" CP cast	C60806	1/20
D50310	4" CP cast w/ring	C60806/C60818	1/20
D50334	4" CP cast square	C60812	1/20
D50335	4" PB cast square	C60813	1/20

2" x 3" Shower/Floor Drain with Square Strainer

Fits Over 2" or Inside 3" Schedule 40 DWV Pipe

MADE IN THE **USA**



- Low profile for first and second floor installations
- Beveled edge allows for recessed installation
- Reversible clamping ring for additional 1/2" height adjustment
- Brass inserts ensure secure clamping of membrane
- Dual weeps holes
- Recessed sump area for added drainage

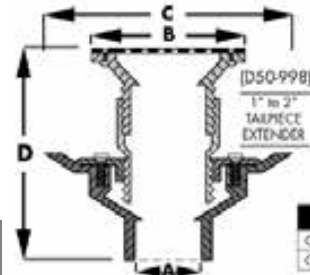

• Use **D50998** Tailpiece Extension (listed below) when additional height is needed.

A	B	C	D
Over 2" pipe	4-1/4"	6-1/2"	3-1/4" - 4-3/8"
Over 3" pipe	4-1/4"	6-1/2"	3-1/4" - 4-3/8"

PVC

PART NO.	STRAINER	CTN/MSTR
D50141	4" NB square	1/20

2" x 3" Shower Drain with 2" Spud and 4" Square Snap-in Strainer



- No screws
- Four prong installation
- Plastic spud

PART NO.	STRAINER	CTN/MSTR
D5088BN	4" BN square	1/1
D5088RB	4" RB square	1/1
D5088WB	4" WB square	1/1
D50888	4" SS square	1/1

Tailpiece Extension



- Use when additional height is needed
- Compensates for thick shower bases

MADE IN THE **USA**

PART NO.	DESCRIPTION	CTN/MSTR
D50998	1" - 2" tailpiece extension	1/1

Brass Drain Extension



- 2" MIP x 2" FIP for 2" drain spuds
- Use when additional height is required to overcome inconsistent concrete pours
- Height extension from 1-1/2" to 3-1/2"
- Solid brass construction

PART NO.	DESCRIPTION	CTN/MSTR
D60978	Brass drain extension	1/1

2" x 3" Shower/Floor Drain with Brass Tailpiece

Fits Over 2" or Inside 3" Schedule 40 DWV Pipe

MADE IN THE **USA**



- Low profile for first and second floor installations
- Beveled edge allows for recessed installation
- Reversible clamping ring for additional 1/2" height adjustment
- Brass inserts ensure secure clamping of membrane
- Dual weeps holes
- Recessed sump area for added drainage

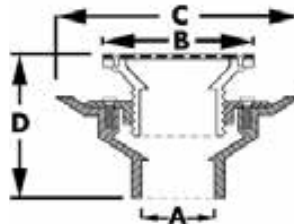

A	B	C	D
Over 2" pipe	4-1/4"	6-1/2"	3-1/4" - 4-3/8"
Over 3" pipe	4-1/4"	6-1/2"	3-1/4" - 4-3/8"

PVC

PART NO.	STRAINER	REPL. STRAINER	CTN/MSTR
D50101	4" SS round	D60780	1/20
D50111	4" CP round	D60781	1/20
D50102	4" PB round	D60782	1/20
D50800	6" CP round	-	1/20
D50802	6" PB round	-	1/20
D50161	4" CP square	C60812	1/20
D50152	4" PB square	C60813	1/20
D5001BN	4" BN round	-	1/1
D5001RB	4" RB round	-	1/1
D5001WB	4" WB round	-	1/1
D5001NP	4" NP round	-	1/1

ABS

PART NO.	STRAINER	REPL. STRAINER	CTN/MSTR
D50401	4" SS round	D60780	1/20
D50411	4" CP round	D60781	1/20
D50402	4" PB round	D60782	1/20
D50830	6" CP round	-	1/20
D50832	6" PB round	-	1/20
D50162	4" CP square	C60812	1/20
D50153	4" PB square	C60813	1/20

2" Shower/Floor Drain with Brass Tailpiece

Fits Over 2" Schedule 40 DWV Pipe



MADE IN THE
USA

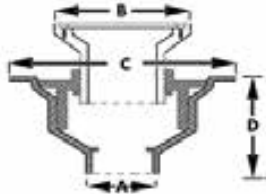

- Overall top
- Brass tailpiece
- Screw-down clamping ring has weep holes for secondary drainage

A	B	C	D
Over 2" pipe	4-1/8" or 6"	7"	3-5/8" - 5-1/4"

PVC

PART NO.	STRAINER	CTN/MSTR
D50710	4" SS round	1/10
D50712	4" PB round	1/10
D50711	4" CP round	1/10
D50721	6" PB round	1/10
D50720	6" CP round	1/10

ABS

PART NO.	STRAINER	CTN/MSTR
D50713	4" SS round	1/10
D50715	4" PB round	1/10
D50714	4" CP round	1/10
D50723	6" PB round	1/10
D50722	6" CP round	1/10

2" x 3" "Perfect Low Profile" Drain

Fits Over 2" or Inside 3" PVC Schedule 40 DWV Pipe



MADE IN THE
USA

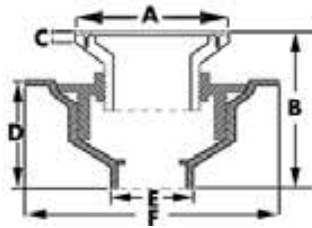

- 3" total height; perfect for multiple stories
- Reversible clamping ring, stainless steel strainer

A	B	C	D	E	F
4-1/4"	MIN: 3" - MAX: 4-1/4"	3/8"	2"	ID: 2-3/8" OD: 3-1/16"	6-5/8"

PVC

PART NO.	STRAINER	CTN/MSTR
D50PLP	4" SS round	1/20

2" x 3" PVC Low Profile Drain



MADE IN THE
USA

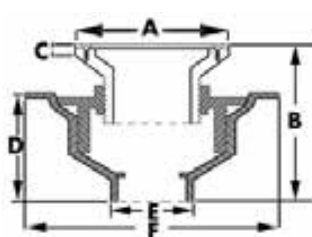

- Primer tapped

A	B	C	D	E	F
4-1/4"	MIN: 3" - MAX: 4-1/4"	3/8"	2"	ID: 2-3/8" OD: 3-1/16"	6-5/8"

PVC

PART NO.	STRAINER	CTN/MSTR
D50125	4" SS round	1/1
D50126	4" NB round cast	1/1

Items marked with the Jones Stephens logo are "You Need It... We Got It" Items.

2" Shower/Floor Drain with Plastic Tailpiece

Fits Over 2" Schedule 40 DWV Pipe



MADE IN THE
USA

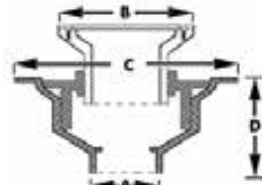

- Overall top
- Plastic tailpiece
- Screw-down clamping ring has weep holes for secondary drainage

A	B	C	D
Over 2" pipe	4-1/4"	7"	3-5/8" - 5-1/8"
With Ring	4-1/4"	7"	3-3/4" - 5-1/4"

PVC

PART NO.	STRAINER	CTN/MSTR
D50700	4" SS round	1/10
D50702	4" PB round	1/10
D50708	4" PB round cast	1/10
D50709	4" PB round with ring	1/10
D50701	4" CP round	1/10
D50706	4" NB round	1/10
D50707	4" NB round with ring	1/10

ABS

PART NO.	STRAINER	CTN/MSTR
D50703	4" SS round	1/10
D50705	4" PB round	1/10
D50726	4" PB round cast	1/10
D50727	4" PB round with ring	1/10
D50704	4" CP round	1/10
D50724	4" NB round	1/10
D50725	4" NB round with ring	1/10

2" No Caulk Shower Drain

Pushes Over 2" DWV Pipe



MADE IN THE
USA

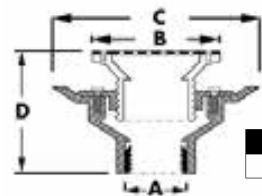

- Overall top
- Tongue-and-grooved beveled clamping ring
- Brass inserts
- Supplied with gasket

A	B	C	D
2" no caulk	4-1/4"	6-1/2"	3-1/2" - 4-3/4"

PVC - PLASTIC TAILPIECE

PART NO.	STRAINER	CTN/MSTR
D50500	4" SS round	1/10
D50510	4" CP round	1/10

PVC - BRASS TAILPIECE

PART NO.	STRAINER	CTN/MSTR
D50501	4" SS round	1/10
D50502	4" PB round	1/10
D50511	4" CP round	1/10

2" No Caulk Shower Stall Drain

Fits Over 2" Schedule 40 DWV Pipe

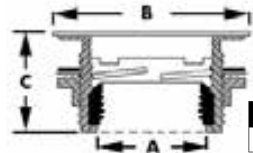

- Overall top
- Snap-in strainer
- Wrench included
- For 2" CTS order gasket separately
- D40140, D40101, D40401, D40010 and D40151 are UPC Listed

A	B	C
2"	4-1/4"	2"

Plastic Body

PART NO.	STRAINER	CTN/MSTR
D40101	4" SS round	1/20
D40151	4" White plastic round	1/20
D40201	4" PB round	1/25
D40401	4" White epoxy coated SS round	1/10

Brass Body

PART NO.	STRAINER	CTN/MSTR
D40140	4" SS round	1/20
D40240	4" PB round	1/36
D40440	4" White epoxy coated SS round	1/10

Snap-In Replacement Strainers

PART NO.	DESCRIPTION	CTN/MSTR
D40005	SS round strainer for solvent outlet drains	1/1
D40003	PB round replacement strainer	1/50
D40004	White epoxy coated SS replacement strainer	1/50
D40006	Replacement wrench key	1/1
D40007	2" Schedule 40 DWV gasket	1/1
D40008	2" CTS replacement gasket	1/1
D40009	White plastic round replacement strainer	1/1
D40010	SN replacement strainer	1/20

2" Drop-In Shower Stall Drain

Fits Over 2" Schedule 40 DWV Pipe

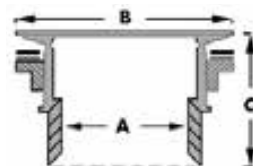

- Drain body drops through shower base
- Locknut tightens from underside
- Snap-in strainer
- D40010 is UPC listed

A	B	C
2"	4-1/4"	2-5/8"

PVC

PART NO.	DESCRIPTION	STRAINER	CTN/MSTR
D41007	Solvent outlet	4" SS	1/25
D41009	Solvent outlet	4" PB	1/20
D41008	No-caulk/solvent outlet	4" SS	1/20

ABS

PART NO.	DESCRIPTION	STRAINER	CTN/MSTR
D41307	Solvent outlet	4" SS	1/25
D41105	Solvent outlet	4" PB	1/20

Snap-In Replacement Strainers

PART NO.	DESCRIPTION	CTN/MSTR
D40005	SS for solvent outlet drains	1/10
D41103	SS for no caulk/solvent drains	1/10
D41104	Snap-in for D41008	1/10
D40010	SN	1/10
D40003	PB	1/10

Items marked with the Jones Stephens logo are "You Need It...We Got It" Items.

2" Shower Stall Drain with Receptor Base

Fits Over 2" Schedule 40 DWV Pipe

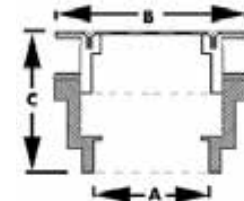

- Allows for secondary drainage
- Accepts knockout test cap for testing
- 3" OD threads

A	B	C
2"	4-1/4"	2"

PVC

PART NO.	STRAINER	CTN/MSTR
D41001	4" SS round	1/25
D41002	4" PB round	1/20
D41003	4" AB round	1/20
D41004	4" SN round	1/20

ABS

PART NO.	STRAINER	CTN/MSTR
D41301	4" SS round	1/20
D41302	4" PB round	1/20
D41303	4" AB round	1/20

PVC - 2" Offset

PART NO.	STRAINER	CTN/MSTR
D41600	4" SS round	1/25

ABS - 2" Offset

PART NO.	STRAINER	CTN/MSTR
D41601	4" SS round	1/25

Replacement Strainers with Screws

PART NO.	DESCRIPTION	CTN/MSTR
D41101	SS round replacement strainer with screws	50/250
D41102	PB round replacement strainer with screws	50/250
D41107	SN round replacement strainer with screws	50/250

PVC LevelBest Drainage and Cleanout System

Pages 189-190

SIZES: 2" x 3", 3", 3" x 4", 4"



For use in applications where adjustments after the concrete pour are required.

Adapter

Allows adjustment to floor level after concrete is poured!

MADE IN THE
USA



- PVC, ABS or Cast Iron drains compatible
- Industry standard iron pipe size threads compatible with most adapter and drain bodies
- Compatible with most plastic and brass spuds used in the industry
- Includes the spacer ring that can be used with brass spuds
- Can be used with tile rings

PART NO.	DESCRIPTION	CTN/MSTR
D50448	3-1/2" x 3" x 6"	1/1
D50449	4" x 3-1/2" x 6"	1/1
D50450	4" x 3-1/2" x 5"	1/1
D50451	3-1/2" x 3" x 5"	1/1
D50452	Replacement cap	1/1
D50453	Replacement ring	1/1
D50454	Leveling shim for 5" strainer	1/1

3" x 4" PVC Base with 3-1/2" Adapter

Allows adjustment to floor level after concrete is poured!

MADE IN THE
USA



- PVC, ABS or Cast Iron drains compatible
- Industry standard iron pipe size threads compatible with most adapter and drain bodies
- Includes the spacer ring that can be used with brass spuds
- Can be used with tile rings
- Primer tapped with 1/2" IPS plug

PART NO.	DESCRIPTION	CTN/MSTR
D50440	3" x 4" PVC base with 3-1/2" LevelBest adapter	1/1

Adapter with Spud and Strainer

Allows adjustment to floor level after concrete is poured!

MADE IN THE
USA



- PVC, ABS or Cast Iron drains compatible
- Industry standard iron pipe size threads compatible with most adapter and drain bodies
- Includes the spacer ring that can be used with brass spuds
- Can be used with tile rings

PART NO.	SIZE	SPUD	STRAINER	CTN/MSTR
D50522	3-1/2"	3" Plastic	5" NB round	1/1
D50523	3-1/2"	3" Metal	5" NB round	1/1
D50520	4"	3-1/2" Plastic	5" NB round	1/1
D50521	4"	3-1/2" Metal	5" NB round	1/1
D50524	3-1/2"	3-1/2" Plastic	6" NB round	1/1
D50526	4"	3-1/2" Plastic	6" NB round	1/1

Adapter with Spud and Cleanout

Allows adjustment to floor level after concrete is poured!

MADE IN THE
USA



- PVC, ABS or Cast Iron drains compatible
- Industry standard iron pipe size threads compatible with most adapter and drain bodies
- Includes the spacer ring that can be used with brass spuds
- Can be used with tile rings

PART NO.	PIPE SIZE	SPUD	COVER	CTN/MSTR
D50525	3-1/2"	3" Plastic	6" NB round	1/1

Complete Pipe Fit Drain System

Allows adjustment to floor level after concrete is poured!

MADE IN THE
USA



- Includes the spacer ring that can be used with brass spuds
- Can be used with tile rings
- Primer tapped with 1/2" IPS plug

PART NO.	PIPE SIZE	SPUD	STRAINER	CTN/MSTR
D50460	3" x 4"	3" Plastic	5" NB round	1/1
D50461	3" x 4"	3" Metal	5" NB round	1/1
D50473	3" x 4"	3" Plastic	6" NB round	1/1
D50486	3" x 4"	3-1/2" Plastic	5" NB round	1/1
D50469	3" x 4"	3" Plastic	6" NB square	1/1
D50472	4"	3-1/2" Plastic	6" NB round	1/1
D50470	4"	3-1/2" Plastic	5" NB round	1/1
D50471	4"	3-1/2" Metal	5" NB round	1/1
D50465	4"	3" Metal	5" NB round	1/1
D50464	4"	3" Plastic	5" NB round	1/1
D50474	4"	3" Plastic	6" NB round	1/1

Complete Pipe Fit Cleanout System

Allows adjustment to floor level after concrete is poured!

MADE IN THE
USA



- Includes the spacer ring that can be used with brass spuds
- Can be used with tile rings

PART NO.	PIPE SIZE	SPUD	COVER	CTN/MSTR
C59242	3" x 4"	3" Plastic	5" NB round	1/1
C59252	3" x 4"	3-1/2" Plastic	5" NB round	1/1
D50481	3" x 4"	3" Plastic	6" NB round	1/1
C59244	4"	3" Plastic	5" NB round	1/1
C59245	4"	3" Metal	5" NB round	1/1
C59250	4"	3-1/2" Plastic	5" NB round	1/1
C59251	4"	3-1/2" Metal	5" NB round	1/1
D50482	4"	3" Plastic	6" NB round	1/1
D50480	4"	3-1/2" Plastic	6" NB round	1/1

Complete Hub Fit Drain System

Allows adjustment to floor level after concrete is poured!

MADE IN THE
USA



- Includes the spacer ring that can be used with brass spuds
- Can be used with tile rings

PART NO.	PIPE SIZE	SPUD	STRAINER	CTN/MSTR
D50462	4"	3" Plastic	5" NB round	1/1
D50463	4"	3" Metal	5" NB round	1/1

Complete Hub Fit Cleanout System

Allows adjustment to floor level after concrete is poured!

MADE IN THE
USA



- Includes the spacer ring that can be used with brass spuds
- Can be used with tile rings

PART NO.	PIPE SIZE	SPUD	COVER	CTN/MSTR
C59240	4"	3" Plastic	5" NB round	1/1
C59241	4"	3" Metal	5" NB round	1/1

Complete Heavy Duty Drain System

Allows adjustment to floor level after concrete is poured!

MADE IN THE
USA



- Includes the spacer ring that can be used with brass spuds
- Can be used with tile rings
- Completely adjustable; reversible clamping ring gains additional 1" height
- 8-1/2" Pan primer tapped with 1/2" plug
- Extra weep holes

PART NO.	PIPE SIZE	SPUD	STRAINER	CTN/MSTR
D49640	4"	3" Plastic	5" NB round	1/1
D49641	4"	3" Metal	5" NB round	1/1
D49646	4"	3-1/2" Plastic	5" NB round	1/1
D49647	4"	3-1/2" Metal	5" NB round	1/1
D49644	2" x 3"	3" Plastic	5" NB round	1/1
D49645	2" x 3"	3" Metal	5" NB round	1/1
D49650	2" x 3"	3-1/2" Plastic	5" NB round	1/1
D49651	2" x 3"	3-1/2" Metal	5" NB round	1/1
D49642	3" x 4"	3" Plastic	5" NB round	1/1
D49643	3" x 4"	3" Metal	5" NB round	1/1
D49648	3" x 4"	3-1/2" Plastic	5" NB round	1/1
D49649	3" x 4"	3-1/2" Metal	5" NB round	1/1
D50477	3"	3-1/2" Plastic	6" NB round	1/1
D50479	4"	3-1/2" Plastic	6" NB round	1/1

Complete Heavy Duty Slab Drain System

Allows adjustment to floor level after concrete is poured!

MADE IN THE
USA



- Includes the spacer ring that can be used with brass spuds
- Can be used with tile rings
- 8-1/2" Pan for applications where no clamping ring is required
- Primer tapped with 1/2" plug
- Completely adjustable

PART NO.	PIPE SIZE	SPUD	STRAINER	CTN/MSTR
D49656	2" x 3"	3" Plastic	5" NB round	1/1
D49657	2" x 3"	3" Metal	5" NB round	1/1
D49662	2" x 3"	3-1/2" Plastic	5" NB round	1/1
D49663	2" x 3"	3-1/2" Metal	5" NB round	1/1
D49654	3" x 4"	3" Plastic	5" NB round	1/1
D49655	3" x 4"	3" Metal	5" NB round	1/1
D49660	3" x 4"	3-1/2" Plastic	5" NB round	1/1
D49661	3" x 4"	3-1/2" Metal	5" NB round	1/1
D49652	4"	3" Plastic	5" NB round	1/1
D49653	4"	3" Metal	5" NB round	1/1
D49658	4"	3-1/2" Plastic	5" NB round	1/1
D49659	4"	3-1/2" Metal	5" NB round	1/1

Items marked with the Jones Stephens logo are "You Need It... We Got It" Items.

PVC and ABS Commercial Pipe/Hub Fit Adapter Drains

Pages 191-197

SIZES: 2", 3", 3"x 4", 4"



For use in applications where a membrane is not required.

3"x 4" Pipe Fit Base with 3-1/2" Plastic Spud

Fits Over 3" or Inside 4" Schedule 40 DWV Pipe

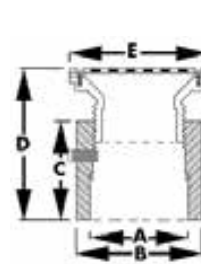

- Strainers available in SS, PB, NB and CP
- SS strainers are .06" thick
- PB, NB and CP strainers are 3/16" thick
- Primer tapped, includes 1/2" plug
- Adjustable (see dimension D)

STRAINER	A	B	C	D	E
5" round	Over 3" pipe	Inside 4" pipe	4-1/2"	5-1/16" - 7-1/8"	5-3/16"
5" round with ring	Over 3" pipe	Inside 4" pipe	4-1/2"	5-13/16" - 7-1/4"	5-1/2"
6" round	Over 3" pipe	Inside 4" pipe	4-1/2"	5-3/4" - 7-1/4"	6-1/8"
6" round with ring	Over 3" pipe	Inside 4" pipe	4-1/2"	6-1/16" - 7-5/16"	6-1/2"
6" square	Over 3" pipe	Inside 4" pipe	4-1/2"	5-3/4" - 7-1/8"	6"
7" square	Over 3" pipe	Inside 4" pipe	4-1/2"	5-15/16" - 7-3/8"	7"

PVC

PART NO.	STRAINER	CTN/MSTR
D53428	5" SS round	1/1
D53429	5" PB round	1/1
D53430	5" PB round with ring	1/1
D53431	5" NB round	1/1
D53432	5" NB round with ring	1/1
D53433	5" CP round	1/1
D53434	5" CP round with ring	1/1
D53020	6" SS round	1/1
D53022	6" PB round	1/1
D53074	6" PB round with ring	1/1
D53072	6" NB round	1/1
D53076	6" NB round with ring	1/1
D53021	6" CP round	1/1
D53284	6" CP round with ring	1/1
D59900	5" NB round with 6" square top	1/1

ABS

PART NO.	STRAINER	CTN/MSTR
D53435	5" SS round	1/1
D53436	5" PB round	1/1
D53437	5" PB round with ring	1/1
D53438	5" NB round	1/1
D53439	5" NB round with ring	1/1
D53440	5" CP round	1/1
D53441	5" CP round with ring	1/1
D53023	6" SS round	1/1
D53025	6" PB round	1/1
D53075	6" PB round with ring	1/1
D53073	6" NB round	1/1
D53077	6" NB round with ring	1/1
D53024	6" CP round	1/1
D53285	6" CP round with ring	1/1
D53249	5" NB round with 7" square top	1/1

3"x 4" Pipe Fit Base with 3-1/2" Metal Spud

Fits Over 3" or Inside 4" Schedule 40 DWV Pipe

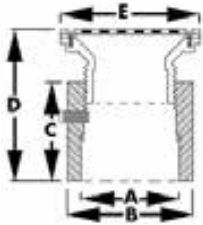

- Strainers are available in PB, NB and CP
- Strainers are 3/16" thick
- Primer tapped, includes 1/2" plug
- Adjustable (see dimension D)

STRAINER	A	B	C	D	E
5" round	Over 3" pipe	Inside 4" pipe	4-1/2"	4-7/8" - 6-1/16"	5"
6" round	Over 3" pipe	Inside 4" pipe	4-1/2"	5-5/16" - 6-11/16"	6"
8" round	Over 3" pipe	Inside 4" pipe	4-1/2"	5-3/8" - 6-7/8"	8"
9" round	Over 3" pipe	Inside 4" pipe	4-1/2"	5-3/8" - 6-7/8"	9"
5" or 6" square top	Over 3" pipe	Inside 4" pipe	4-1/2"	5-3/4" - 7-1/8"	5" or 6"

PVC

PART NO.	STRAINER	CTN/MSTR
D53027	5" PB round	1/1
D53124	5" NB round	1/1
D53026	5" CP round	1/1
D53029	6" PB round	1/1
D53125	6" NB round	1/1
D53028	6" CP round	1/1
D53031	8" PB round	1/1
D53138	8" NB round	1/1
D53142	9" PB round	1/1
D53140	9" NB round	1/1
D53078	5" PB square	1/1
D53082	5" NB square	1/1
D53080	6" PB square	1/1
D53084	6" NB square	1/1

ABS

PART NO.	STRAINER	CTN/MSTR
D53033	5" PB round	1/1
D53126	5" NB round	1/1
D53032	5" CP round	1/1
D53035	6" PB round	1/1
D53127	6" NB round	1/1
D53034	6" CP round	1/1
D53037	8" PB round	1/1
D53139	8" NB round	1/1
D53143	9" PB round	1/1
D53141	9" NB round	1/1
D53079	5" PB square	1/1
D53083	5" NB square	1/1
D53081	6" PB square	1/1
D53085	6" NB square	1/1

2" Over Pipe Fit Base with 2" Plastic Spud

Fits Over 2" Schedule 40 DWV Pipe

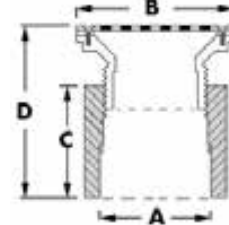

- Strainers are available in SS, PB, NB and CP
- Stainless steel strainers are .06" thick
- PB, NB and CP strainers are 3/16" thick
- Adjustable (see dimension D)

STRAINER	A	B	C	D
4" round	Over 2" pipe	4-1/4"	1-3/4"	3-3/8" - 3-13/16"
4" round with ring	Over 2" pipe	4-1/4"	1-3/4"	3-1/2" - 3-7/8"
4" square	Over 2" pipe	4-1/4"	1-3/4"	3-3/16" - 3-11/16"

PVC

PART NO.	STRAINER	CTN/MSTR
D53190	4" SS round	1/1
D53194	4" PB round stamped	1/1
D53196	4" PB round cast	1/1
D53200	4" PB round with ring	1/1
D53198	4" NB round	1/1
D53202	4" NB round with ring	1/1
D53325	4" NB round with ring and 1/2" PT	1/1
D53192	4" CP round	1/1
D53290	4" CP round with ring	1/1
D53298	4" PB square	1/1
D53296	4" CP square	1/1

ABS

PART NO.	STRAINER	CTN/MSTR
D53191	4" SS round	1/1
D53195	4" PB round stamped	1/1
D53197	4" PB round cast	1/1
D53201	4" PB round with ring	1/1
D53199	4" NB round	1/1
D53203	4" NB round with ring	1/1
D53193	4" CP round	1/1
D53291	4" CP round with ring	1/1
D53299	4" PB square	1/1
D53297	4" CP square	1/1

2" Over Pipe Fit Base with 2" Metal Spud

Fits Over 2" Schedule 40 DWV Pipe

MADE IN THE
USA

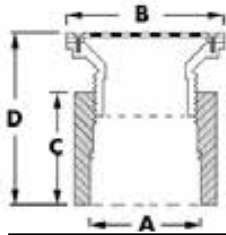

- Strainers are available in SS, PB and CP
- Stainless steel strainers are .06" thick
- PB and CP strainers are 3/16" thick
- Adjustable (see dimension D)

STRAINER	A	B	C	D
4" round	Over 2" pipe	4-1/4"	1-3/4"	3-1/8" - 3-5/8"
6" round	Over 2" pipe	6"	1-3/4"	3-1/8" - 3-5/8"

PVC

PART NO.	STRAINER	CTN/MSTR
D53204	4" SS round	1/1
D53208	4" PB round	1/1
D53206	4" CP round	1/1
D53218	6" PB round	1/1
D53216	6" CP round	1/1

ABS

PART NO.	STRAINER	CTN/MSTR
D53205	4" SS round	1/1
D53209	4" PB round	1/1
D53207	4" CP round	1/1
D53219	6" PB round	1/1
D53217	6" CP round	1/1

3" Over Pipe Fit Base with 3" Plastic Spud

Fits Over 3" Schedule 40 DWV Pipe

MADE IN THE
USA

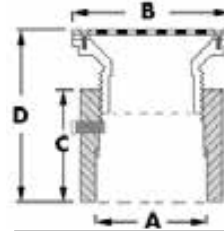

- Strainers are available in SS, PB, NB and CP
- Stainless steel strainers are .06" thick
- PB, NB and CP strainers are 3/16" thick
- Primer tapped, includes 1/2" plug
- Adjustable (see dimension D)

STRAINER	A	B	C	D
6" round	Over 3" pipe	6-1/8"	3-7/8"	4-13/16" - 5-3/4"
6" round with ring	Over 3" pipe	6-1/2"	3-7/8"	4-15/16" - 5-13/16"
7" square	Over 3" pipe	7"	3-7/8"	4-13/16" - 6-1/8"

PVC

PART NO.	STRAINER	CTN/MSTR
D53100	6" SS round	1/1
D53104	6" PB round	1/1
D53108	6" PB round with ring	1/1
D53106	6" NB round	1/1
D53110	6" NB round with ring	1/1
D53102	6" CP round	1/1
D53288	6" CP round with ring	1/1
D53260	5" NB round with 7" square top	1/1

ABS

PART NO.	STRAINER	CTN/MSTR
D53101	6" SS round	1/1
D53105	6" PB round	1/1
D53109	6" PB round with ring	1/1
D53107	6" NB round	1/1
D53111	6" NB round with ring	1/1
D53103	6" CP round	1/1
D53289	6" CP round with ring	1/1
D53261	5" NB round with 7" square top	1/1

3" Over Pipe Fit Base with 3" Metal Spud

Fits Over 3" Schedule 40 DWV Pipe

MADE IN THE
USA

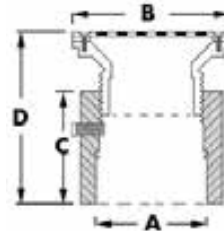

- Strainers are available in PB and NB
- Strainers are 3/16" thick
- Primer tapped, includes 1/2" plug
- Adjustable (see dimension D)

STRAINER	A	B	C	D
5" round	Over 3" pipe	5"	3-7/8"	4-15/16" - 5-3/4"

PVC

PART NO.	STRAINER	CTN/MSTR
D53312	5" PB round	1/1
D53306	5" NB round	1/1

ABS

PART NO.	STRAINER	CTN/MSTR
D53313	5" PB round	1/1
D53307	5" NB round	1/1

4" Over Pipe Fit Base with 3-1/2" Plastic Spud

Fits Over 4" Schedule 40 DWV Pipe



- Strainers are available in SS, PB, NB and CP
- Stainless steel strainers are .06" thick
- PB, NB and CP strainers are 3/16" thick
- Primer tapped, includes 1/2" plug
- Adjustable (see dimension D)

STRAINER	A	B	C	D
5" round	Over 4" pipe	5-3/16"	4-3/4"	6" - 7-3/8"
5" round with ring	Over 4" pipe	5-1/2"	4-3/4"	6-1/8" - 7-1/2"
6" round	Over 4" pipe	6-1/8"	4-3/4"	6" - 7-1/2"
6" round with ring	Over 4" pipe	6-1/2"	4-3/4"	6-1/4" - 7-5/8"
7" square	Over 4" pipe	7"	4-3/4"	5-1/2" - 6-7/8"

PVC

PART NO.	STRAINER	CTN/MSTR
D53414	5" SS round	1/1
D53415	5" PB round	1/1
D53416	5" PB round with ring	1/1
D53417	5" NB round	1/1
D53418	5" NB round with ring	1/1
D53419	5" CP round	1/1
D53420	5" CP round with ring	1/1
D53040	6" SS round	1/1
D53088	6" PB round with ring	1/1
D53086	6" NB round	1/1
D53090	6" NB round with ring	1/1
D53041	6" CP round	1/1
D53282	6" CP round with ring	1/1
D53252	5" NB round with 7" square top	1/1

ABS

PART NO.	STRAINER	CTN/MSTR
D53421	5" SS round	1/1
D53422	5" PB round	1/1
D53423	5" PB round with ring	1/1
D53424	5" NB round	1/1
D53425	5" NB round with ring	1/1
D53426	5" CP round	1/1
D53427	5" CP round with ring	1/1
D53043	6" SS round	1/1
D53045	6" PB round	1/1
D53089	6" PB round with ring	1/1
D53087	6" NB round	1/1
D53091	6" NB round with ring	1/1
D53044	6" CP round	1/1
D53283	6" CP round with ring	1/1
D53253	5" NB round with 7" square top	1/1

4" Over Pipe Fit Base with 3-1/2" Metal Spud

Fits Over 4" Schedule 40 DWV Pipe



- Strainers are available in PB, NB and CP
- Strainers are 3/16" thick
- Primer tapped, includes 1/2" plug
- Adjustable (see dimension D)

STRAINER	A	B	C	D
5" round	Over 4" pipe	5-3/16"	4-3/4"	5-1/8" - 6-3/8"
6" round	Over 4" pipe	6-3/16"	4-3/4"	5-5/16" - 6-5/8"
8" round	Over 4" pipe	8"	4-3/4"	5-1/2" - 7"
9" round	Over 4" pipe	9"	4-3/4"	5-1/2" - 7-1/8"
5" or 6" square	Over 4" pipe	5" or 6"	4-3/4"	5-5/16" - 6-5/8"

PVC

PART NO.	STRAINER	CTN/MSTR
D53047	5" PB round	1/1
D53128	5" NB round	1/1
D53046	5" CP round	1/1
D53049	6" PB round	1/1
D53129	6" NB round	1/1
D53048	6" CP round	1/1
D53051	8" PB round	1/1
D53132	8" NB round	1/1
D53136	9" PB round	1/1
D53134	9" NB round	1/1
D53092	5" PB square	1/1
D53096	5" NB square	1/1
D53094	6" PB square	1/1
D53098	6" NB square	1/1

ABS

PART NO.	STRAINER	CTN/MSTR
D53053	5" PB round	1/1
D53130	5" NB round	1/1
D53052	5" CP round	1/1
D53055	6" PB round	1/1
D53131	6" NB round	1/1
D53054	6" CP round	1/1
D53057	8" PB round	1/1
D53133	8" NB round	1/1
D53137	9" PB round	1/1
D53135	9" NB round	1/1
D53093	5" PB square	1/1
D53097	5" NB square	1/1
D53095	6" PB square	1/1
D53099	6" NB square	1/1

4" Over Pipe Fit Base with 4" Plastic Spud

Fits Over 4" Schedule 40 DWV Pipe



- Strainers are available in SS, PB, NB and CP
- Stainless steel strainers are .06" thick
- PB, NB and CP strainers are 3/16" thick
- Primer tapped, includes 1/2" plug
- Adjustable (see dimension D)

STRAINER	A	B	C	D
6" round	Over 4" pipe	6-1/8"	4-3/4"	6" - 7-3/16"
6" round with ring	Over 4" pipe	6-1/2"	4-3/4"	6-1/8" - 7-5/16"
7" square	Over 4" pipe	7"	4-3/4"	6-1/16" - 7-3/8"

PVC

PART NO.	STRAINER	CTN/MSTR
D53262	6" SS round	1/4
D53263	6" PB round	1/4
D53264	6" PB round with ring	1/4
D53265	6" NB round	1/4
D53266	6" NB round with ring	1/4
D53269	6" CP round	1/4
D53286	6" CP round with ring	1/4
D53268	5" NB round with 7" square top	1/1

ABS

PART NO.	STRAINER	CTN/MSTR
D53272	6" SS round	1/4
D53273	6" PB round	1/4
D53274	6" PB round with ring	1/4
D53275	6" NB round	1/4
D53276	6" NB round with ring	1/4
D53279	6" CP round	1/4
D53287	6" CP round with ring	1/4
D53278	5" NB round with 7" square top	1/1

4" Over Pipe Fit Base with 4" Metal Spud

Fits Over 4" Schedule 40 DWV Pipe



- Strainers are available in PB and NB
- Strainers are 3/16" thick
- Primer tapped, includes 1/2" plug
- Adjustable (see dimension D)

STRAINER	A	B	C	D
5" round	Over 4" pipe	5"	4-3/4"	6-1/16" - 7-3/8"

PVC

PART NO.	STRAINER	CTN/MSTR
D53308	5" PB round	1/4
D53304	5" NB round	1/4

ABS

PART NO.	STRAINER	CTN/MSTR
D53309	5" PB round	1/4
D53305	5" NB round	1/4

3" Inside Pipe Fit Base with 2" Plastic Spud

Fits Inside 3" Schedule 40 DWV Pipe



- Strainers are available in SS, PB, NB and CP
- Stainless steel strainers are .06" thick
- PB, NB and CP strainers are 3/16" thick
- Adjustable (see dimension C)

STRAINER	A	B	C
4" round	Inside 3" pipe	4-1/4"	2-5/8" - 3-7/8"
4" round with ring	Inside 3" pipe	4-1/2"	2-11/16" - 4"
4" square	Inside 3" pipe	4-1/4"	2-1/2" - 3-13/16"

PVC

PART NO.	STRAINER	CTN/MSTR
D53150	4" SS round	1/1
D53154	4" PB round stamped	1/1
D53156	4" PB round cast	1/1
D53160	4" PB round with ring	1/1
D53158	4" NB round	1/1
D53162	4" NB round with ring	1/1
D53152	4" CP round	1/1
D53294	4" CP round with ring	1/1
D53300	4" CP square	1/1
D53302	4" PB square	1/1

ABS

PART NO.	STRAINER	CTN/MSTR
D53151	4" SS round	1/1
D53155	4" PB round stamped	1/1
D53157	4" PB round cast	1/1
D53161	4" PB round with ring	1/1
D53159	4" NB round	1/1
D53163	4" NB round with ring	1/1
D53153	4" CP round	1/1
D53295	4" CP round with ring	1/1
D53301	4" CP square	1/1
D53303	4" PB square	1/1

3" Inside Pipe Fit Base with 2" Metal Spud

Fits Inside 3" Schedule 40 DWV Pipe

MADE IN THE
USA

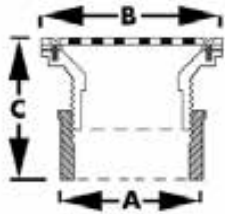

- Strainers are available in SS, PB and CP
- Stainless steel strainers are .06" thick
- PB and CP strainers are 3/16" thick
- Adjustable (see dimension C)

STRAINER	A	B	C
4" or 6" round	Inside 3" pipe	4-1/4" or 6"	2-7/16" - 3-3/4"

PVC

PART NO.	STRAINER	CTN/MSTR
D53180	4" SS round	1/1
D53184	4" PB round	1/1
D53182	4" CP round	1/1
D53188	6" PB round	1/1
D53186	6" CP round	1/1

ABS

PART NO.	STRAINER	CTN/MSTR
D53181	4" SS round	1/1
D53185	4" PB round	1/1
D53183	4" CP round	1/1
D53189	6" PB round	1/1
D53187	6" CP round	1/1

4" Inside Pipe Fit Base with 3" Metal Spud

Fits Inside 4" Schedule 40 DWV Pipe

MADE IN THE
USA

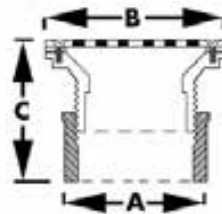

- Strainers are available in PB and NB
- Strainers are 3/16" thick
- Adjustable (see dimension C)

STRAINER	A	B	C
5" round	Inside 4" pipe	5"	2-5/8" - 3-1/2"

PVC

PART NO.	STRAINER	CTN/MSTR
D53314	5" PB round	1/1
D53310	5" NB round	1/1

ABS

PART NO.	STRAINER	CTN/MSTR
D53315	5" PB round	1/1
D53311	5" NB round	1/1

4" Inside Pipe Fit Base with 3" Plastic Spud

Fits Inside 4" Schedule 40 DWV Pipe

MADE IN THE
USA

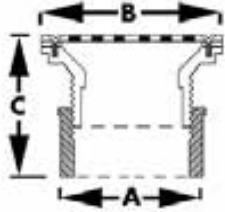

- Strainers are available in SS, PB, NB and CP
- Stainless steel strainers are .06" thick
- PB, NB and CP strainers are 3/16" thick
- Adjustable (see dimension C)

STRAINER	A	B	C
6" round	Inside 4" pipe	6-1/8"	3-13/16" - 4-5/8"
6" round with ring	Inside 4" pipe	6-1/2"	4" - 4-13/16"

PVC

PART NO.	STRAINER	CTN/MSTR
D53230	6" SS round	1/1
D53232	6" PB round	1/1
D53238	6" PB round with ring	1/1
D53234	6" NB round	1/1
D53240	6" NB round with ring	1/1
D53236	6" CP round	1/1
D53292	6" CP round with ring	1/1

ABS

PART NO.	STRAINER	CTN/MSTR
D53231	6" SS round	1/1
D53233	6" PB round	1/1
D53239	6" PB round with ring	1/1
D53235	6" NB round	1/1
D53241	6" NB round with ring	1/1
D53237	6" CP round	1/1
D53293	6" CP round with ring	1/1

4" Hub Fit Base with 3-1/2" Plastic Spud

Fits Inside 4" Schedule 40 DWV Pipe

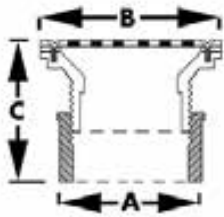

MADE IN THE USA

- Strainers are available in SS, PB, NB and CP
- Stainless steel strainers are .06" thick
- PB, NB and CP strainers are 3/16" thick
- Adjustable (see dimension C)

STRAINER	A	B	C
5" round	4" hub fit	5-3/16"	3" - 4-1/2"
5" round with ring	4" hub fit	5-1/2"	3-1/8" - 4-5/8"
6" round	4" hub fit	6-1/8"	3-1/16" - 4-11/16"
6" round with ring	4" hub fit	6-1/2"	3-1/4" - 4-3/4"

PVC

PART NO.	STRAINER	CTN/MSTR
D53400	5" SS round	1/1
D53401	5" PB round	1/1
D53402	5" PB round with ring	1/1
D53403	5" NB round	1/1
D53404	5" NB round with ring	1/1
D53405	5" CP round	1/1
D53406	5" CP round with ring	1/1
D53017	6" SS round	1/1
D53001	6" PB round	1/1
D53060	6" PB round with ring	1/1
D53058	6" NB round	1/1
D53062	6" NB round with ring	1/1
D53003	6" CP round	1/1
D53280	6" CP round with ring	1/1

ABS

PART NO.	STRAINER	CTN/MSTR
D53407	5" SS round	1/1
D53408	5" PB round	1/1
D53409	5" PB round with ring	1/1
D53410	5" NB round	1/1
D53411	5" NB round with ring	1/1
D53412	5" CP round	1/1
D53413	5" CP round with ring	1/1
D53018	6" SS round	1/1
D53002	6" PB round	1/1
D53061	6" PB round with ring	1/1
D53059	6" NB round	1/1
D53063	6" NB round with ring	1/1
D53004	6" CP round	1/1
D53281	6" CP round with ring	1/1

4" Hub Fit Base with 3-1/2" Metal Spud

Fits Inside 4" Schedule 40 DWV Pipe

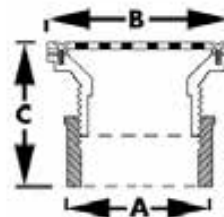

MADE IN THE USA

- Strainers are available in PB, NB and CP
- Strainers are 3/16" thick
- Adjustable (see dimension C)

STRAINER	A	B	C
5" round	5" hub fit	5-3/16"	2-3/8" - 3-5/8"
6" round	6" hub fit	6-3/16"	2-5/8" - 4"
5" or 6" square	4" hub fit	5" or 6"	2-3/4" - 4-3/16"

PVC

PART NO.	STRAINER	CTN/MSTR
D53005	5" PB round	1/1
D53120	5" NB round	1/1
D53011	5" CP round	1/1
D53006	6" PB round	1/1
D53121	6" NB round	1/1
D53012	6" CP round	1/1
D53064	5" PB square	1/4
D53068	5" NB square	1/4
D53066	6" PB square	1/4
D53070	6" NB square	1/4

ABS

PART NO.	STRAINER	CTN/MSTR
D53008	5" PB round	1/1
D53122	5" NB round	1/1
D53014	5" CP round	1/1
D53009	6" PB round	1/1
D53123	6" NB round	1/1
D53015	6" CP round	1/1
D53065	5" PB square	1/4
D53069	5" NB square	1/4
D53067	6" PB square	1/4
D53071	6" NB square	1/4

PVC and ABS 8-1/2" Pan Commercial Drains

Pages 198-204

SIZES: 2" x 3", 3" x 4", 4"



For use in applications where a membrane is required.

2" x 3" Drain Base with 3" Plastic Spud

Fits Over 2" and Inside 3" Schedule 40 DWV Pipe

MADE IN THE USA

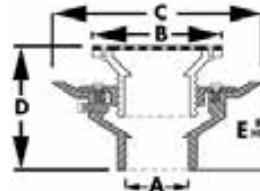

- Completely adjustable; reversible clamping ring gains additional 1" height (Dimension D)
- Strainers are available in SS, PB, NB and CP
- Stainless steel strainers are .06" thick
- PB, NB and CP strainers are 3/16" thick
- 8-1/2" pan primer tapped with 1/2" plug
- Gray PVC or Black ABS
- Extra weep holes

STRAINER	A	B	C	D	E
6" round stainless steel	Over 2" Inside 3"	6-1/8"	8-9/16"	5-1/16" - 6-3/16"	3-3/4"
6" round	Over 2" Inside 3"	6-1/8"	8-9/16"	5-1/8" - 6-3/8"	3-3/4"
6" with ring	Over 2" Inside 3"	6-7/16"	8-9/16"	5-5/16" - 6-3/16"	3-3/4"

PVC

PART NO.	STRAINER	CTN/MSTR
D49001	6" SS round	1/1
D49003	6" PB round	1/1
D49005	6" PB round with ring	1/1
D49007	6" NB round	1/1
D49009	6" NB round with ring	1/1
D49011	6" CP round	1/1
D49013	6" CP round with ring	1/1

ABS

PART NO.	STRAINER	CTN/MSTR
D49002	6" SS round	1/1
D49004	6" PB round	1/1
D49006	6" PB round with ring	1/1
D49008	6" NB round	1/1
D49010	6" NB round with ring	1/1
D49012	6" CP round	1/1
D49014	6" CP round with ring	1/1

2" x 3" Drain Base with 3" Metal Spud

Fits Over 2" and Inside 3" Schedule 40 DWV Pipe

MADE IN THE USA

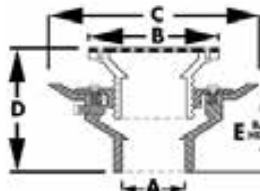

- Completely adjustable; reversible clamping ring gains additional 1" height (Dimension D)
- Strainers are available in PB and NB
- Strainers are 3/16" thick
- 8-1/2" pan primer tapped with 1/2" plug
- Gray PVC or Black ABS
- Extra weep holes

STRAINER	A	B	C	D	E
5" round	Over 2" Inside 3"	5-3/16"	8-9/16"	4-3/16" - 5-3/8"	3-3/4"

PVC

PART NO.	STRAINER	CTN/MSTR
D49019	5" PB round	1/1
D49021	5" NB round	1/1

ABS

PART NO.	STRAINER	CTN/MSTR
D49020	5" PB round	1/1
D49022	5" NB round	1/1

2" x 3" Drain Base with 3-1/2" Plastic Spud

Fits Over 2" and Inside 3" Schedule 40 DWV Pipe

MADE IN THE
USA

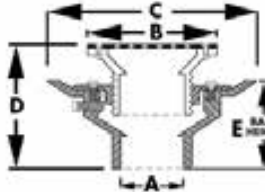

- Completely adjustable; reversible clamping ring gains additional 1" height (Dimension D)
- Strainers are available in SS, PB, NB and CP
- Stainless steel strainers are .06" thick
- PB, NB and CP strainers are 3/16" thick
- 8-1/2" pan primer tapped with 1/2" plug
- Gray PVC or Black ABS
- Extra weep holes

STRAINER	A	B	C	D	E
5" round stainless steel	Over 2" Inside 3"	5-1/4"	8-9/16"	4-5/8" - 6-1/8"	3-3/4"
5" round	Over 2" Inside 3"	5-1/4"	8-9/16"	4-11/16" - 6-1/4"	3-3/4"
5" round with ring	Over 2" Inside 3"	5-9/16"	8-9/16"	4-3/4" - 6-5/16"	3-3/4"
6" round stainless steel	Over 2" Inside 3"	6-1/4"	8-9/16"	4-13/16" - 6-1/4"	3-3/4"
6" round	Over 2" Inside 3"	6-1/4"	8-9/16"	4-15/16" - 6-5/16"	3-3/4"
6" round with ring	Over 2" Inside 3"	6-9/16"	8-9/16"	5-1/16" - 6-1/2"	3-3/4"

PVC

PART NO.	STRAINER	CTN/MSTR
D49023	5" SS round	1/1
D49025	5" PB round	1/1
D49027	5" PB round with ring	1/1
D49029	5" NB round	1/1
D49031	5" NB round with ring	1/1
D49033	5" CP round	1/1
D49035	5" CP round with ring	1/1
D49037	6" SS round	1/1
D49039	6" PB round	1/1
D49041	6" PB round with ring	1/1
D49043	6" NB round	1/1
D49045	6" NB round with ring	1/1
D49047	6" CP round	1/1
D49049	6" CP round with ring	1/1

ABS

PART NO.	STRAINER	CTN/MSTR
D49024	5" SS round	1/1
D49026	5" PB round	1/1
D49028	5" PB round with ring	1/1
D49030	5" NB round	1/1
D49032	5" NB round with ring	1/1
D49034	5" CP round	1/1
D49036	5" CP round with ring	1/1
D49038	6" SS round	1/1
D49040	6" PB round	1/1
D49042	6" PB round with ring	1/1
D49044	6" NB round	1/1
D49046	6" NB round with ring	1/1
D49048	6" CP round	1/1
D49050	6" CP round with ring	1/1

2" x 3" Drain Base with 3-1/2" Metal Spud

Fits Over 2" and Inside 3" Schedule 40 DWV Pipe

MADE IN THE
USA

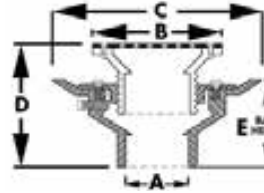

- Completely adjustable; reversible clamping ring gains additional 1" height (Dimension D)
- Strainers are available in PB, NB and CP
- Strainers are 3/16" thick
- 8-1/2" pan primer tapped with 1/2" plug
- Gray PVC or Black ABS
- Extra weep holes

STRAINER	A	B	C	D	E
4" round	Over 2" Inside 3"	4-1/8"	8-9/16"	4-1/8" - 5-1/4"	3-3/4"
5" round	Over 2" Inside 3"	5-3/16"	8-9/16"	4-1/8" - 5-5/16"	3-3/4"
6" round	Over 2" Inside 3"	6-3/16"	8-9/16"	4-5/16" - 5-3/4"	3-3/4"

PVC

PART NO.	STRAINER	CTN/MSTR
D49051	4" PB round	1/1
D49053	4" NB round	1/1
D49055	5" PB round	1/1
D49057	5" NB round	1/1
D49059	5" CP round	1/1
D49061	6" PB round	1/1
D49063	6" NB round	1/1
D49065	6" CP round	1/1

ABS

PART NO.	STRAINER	CTN/MSTR
D49052	4" PB round	1/1
D49054	4" NB round	1/1
D49056	5" PB round	1/1
D49058	5" NB round	1/1
D49060	5" CP round	1/1
D49062	6" PB round	1/1
D49064	6" NB round	1/1
D49066	6" CP round	1/1

2" x 3" Drain Base with 4" Plastic Spud

Fits Over 2" and Inside 3" Schedule 40 DWV Pipe

MADE IN THE **USA**

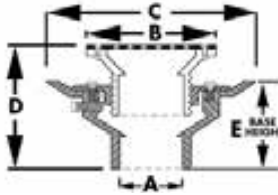

- Completely adjustable; reversible clamping ring gains additional 1" height (Dimension D)
- Strainers are available in SS, PB, NB and CP
- Stainless steel strainers are .06" thick
- PB, NB and CP strainers are 3/16" thick
- 8-1/2" pan primer tapped with 1/2" plug
- Gray PVC or Black ABS
- Extra weep holes

STRAINER	A	B	C	D	E
6" round stainless steel	Over 2" Inside 3"	6-3/16"	8-9/16"	5" - 6-3/16"	3-3/4"
6" round	Over 2" Inside 3"	6-3/16"	8-9/16"	5-1/16" - 6-1/4"	3-3/4"

PVC

PART NO.	STRAINER	CTN/MSTR
D49077	6" SS round	1/1
D49079	6" PB round	1/1
D49081	6" PB round with ring	1/1
D49083	6" NB round	1/1
D49085	6" NB round with ring	1/1
D49087	6" CP round	1/1
D49089	6" CP round with ring	1/1

ABS

PART NO.	STRAINER	CTN/MSTR
D49078	6" SS round	1/1
D49080	6" PB round	1/1
D49082	6" PB round with ring	1/1
D49084	6" NB round	1/1
D49086	6" NB round with ring	1/1
D49088	6" CP round	1/1
D49090	6" CP round with ring	1/1

3" x 4" Drain Base with 3" Plastic Spud

Fits Over 3" and Inside 4" Schedule 40 DWV Pipe

MADE IN THE **USA**

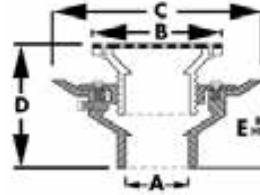

- Completely adjustable; reversible clamping ring gains additional 1" height (Dimension D)
- Strainers are available in SS, PB, NB and CP
- Stainless steel strainers are .06" thick
- PB, NB and CP strainers are 3/16" thick
- 8-1/2" pan primer tapped with 1/2" plug
- Gray PVC or Black ABS
- Extra weep holes

STRAINER	A	B	C	D	E
6" round stainless steel	Over 3" Inside 4"	6-1/8"	8-9/16"	5-1/16" - 6-3/16"	5-3/16"
6" round	Over 3" Inside 4"	6-1/8"	8-9/16"	5-1/8" - 6-3/8"	5-3/16"
6" round with ring	Over 3" Inside 4"	6-7/16"	8-9/16"	5-5/16" - 6-1/2"	5-3/16"

PVC

PART NO.	STRAINER	CTN/MSTR
D49101	6" SS round	1/1
D49103	6" PB round	1/1
D49105	6" PB round with ring	1/1
D49107	6" NB round	1/1
D49109	6" NB round with ring	1/1
D49111	6" CP round	1/1
D49113	6" CP round with ring	1/1

ABS

PART NO.	STRAINER	CTN/MSTR
D49102	6" SS round	1/1
D49104	6" PB round	1/1
D49106	6" PB round with ring	1/1
D49108	6" NB round	1/1
D49110	6" NB round with ring	1/1
D49112	6" CP round	1/1
D49114	6" CP round with ring	1/1

2" x 3" Drain Base with 4" Metal Spud

Fits Over 2" and Inside 3" Schedule 40 DWV Pipe

MADE IN THE **USA**

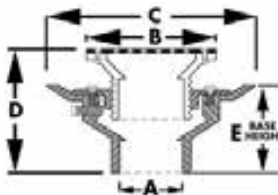

- Completely adjustable; reversible clamping ring gains additional 1" height (Dimension D)
- Strainers are available in PB and NB
- Strainers are 3/16" thick
- 8-1/2" pan primer tapped with 1/2" plug
- Gray PVC or Black ABS
- Extra weep holes

STRAINER	A	B	C	D	E
5" round	Over 2" Inside 3"	5-3/16"	8-9/16"	4-1/8" - 5-3/16"	3-3/4"

PVC

PART NO.	STRAINER	CTN/MSTR
D49095	5" PB round	1/1
D49097	5" NB round	1/1

ABS

PART NO.	STRAINER	CTN/MSTR
D49096	5" PB round	1/1
D49098	5" NB round	1/1

3" x 4" Drain Base with 3" Metal Spud

Fits Over 3" and Inside 4" Schedule 40 DWV Pipe

MADE IN THE **USA**

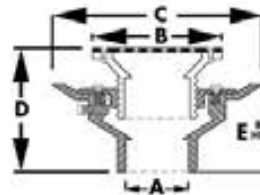

- Completely adjustable; reversible clamping ring gains additional 1" height (Dimension D)
- Strainers are available in PB and NB
- Strainers are 3/16" thick
- 8-1/2" pan primer tapped with 1/2" plug
- Gray PVC or Black ABS
- Extra weep holes

STRAINER	A	B	C	D	E
5" round	Over 3" Inside 4"	5-3/16"	8-9/16"	4-3/16" - 5-3/8"	5-3/16"

PVC

PART NO.	STRAINER	CTN/MSTR
D49119	5" PB round	1/1
D49121	5" NB round	1/1

ABS

PART NO.	STRAINER	CTN/MSTR
D49120	5" PB round	1/1
D49122	5" NB round	1/1

3" x 4" Drain Base with 3-1/2" Plastic Spud

Fits Over 3" and Inside 4" Schedule 40 DWV Pipe

MADE IN THE
USA

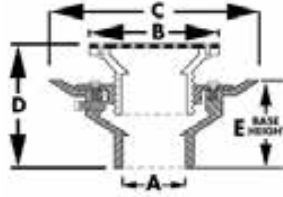

- Completely adjustable; reversible clamping ring gains additional 1" height (Dimension D)
- Strainers are available in SS, PB, NB and CP
- Stainless steel strainers are .06" thick
- PB, NB and CP strainers are 3/16" thick
- 8-1/2" pan primer tapped with 1/2" plug
- Gray PVC or Black ABS
- Extra weep holes

STRAINER	A	B	C	D	E
5" round stainless steel	Over 3" Inside 4"	5-1/4"	8-9/16"	4-5/8" — 6-1/8"	5-1/4"
5" round	Over 3" Inside 4"	5-1/4"	8-9/16"	4-11/16" — 6-1/4"	5-1/4"
5" round with ring	Over 3" Inside 4"	5-9/16"	8-9/16"	4-3/4" — 6-5/16"	5-1/4"
6" round stainless steel	Over 3" Inside 4"	6-1/4"	8-9/16"	4-13/16" — 6-1/4"	5-1/4"
6" round	Over 3" Inside 4"	6-1/4"	8-9/16"	4-15/16" — 6-5/16"	5-1/4"
6" round with ring	Over 3" Inside 4"	6-9/16"	8-9/16"	5-1/16" — 6-1/2"	5-1/4"

PVC

PART NO.	STRAINER	CTN/MSTR
D49123	5" SS round	1/1
D49125	5" PB round	1/1
D49127	5" PB round with ring	1/1
D49129	5" NB round	1/1
D49131	5" NB round with ring	1/1
D49133	5" CP round	1/1
D49135	5" CP round with ring	1/1
D49137	6" SS round	1/1
D49139	6" PB round	1/1
D49141	6" PB round with ring	1/1
D49143	6" NB round	1/1
D49145	6" NB round with ring	1/1
D49147	6" CP round	1/1
D49149	6" CP round with ring	1/1

ABS

PART NO.	STRAINER	CTN/MSTR
D49124	5" SS round	1/1
D49126	5" PB round	1/1
D49128	5" PB round with ring	1/1
D49130	5" NB round	1/1
D49132	5" NB round with ring	1/1
D49134	5" CP round	1/1
D49136	5" CP round with ring	1/1
D49138	6" SS round	1/1
D49140	6" PB round	1/1
D49142	6" PB round with ring	1/1
D49144	6" NB round	1/1
D49146	6" NB round with ring	1/1
D49148	6" CP round	1/1
D49150	6" CP round with ring	1/1

3" x 4" Drain Base with 3-1/2" Metal Spud

Fits Over 3" and Inside 4" Schedule 40 DWV Pipe

MADE IN THE
USA

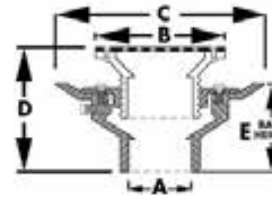

- Completely adjustable; reversible clamping ring gains additional 1" height (Dimension D)
- Strainers are available in PB, NB and CP
- Strainers are 3/16" thick
- 8-1/2" pan primer tapped with 1/2" plug
- Gray PVC or Black ABS
- Extra weep holes

STRAINER	A	B	C	D	E
4" round	Over 3" Inside 4"	4-1/8"	8-9/16"	4-1/8" — 5-1/4"	5-1/4"
5" round	Over 3" Inside 4"	5-3/16"	8-9/16"	4-1/8" — 5-5/16"	5-1/4"
6" round	Over 3" Inside 4"	6-3/16"	8-9/16"	4-5/16" — 5-3/4"	5-1/4"

PVC

PART NO.	STRAINER	CTN/MSTR
D49151	4" PB round	1/1
D49153	4" NB round	1/1
D49155	5" PB round	1/1
D49157	5" NB round	1/1
D49159	5" CP round	1/1
D49161	6" PB round	1/1
D49163	6" NB round	1/1
D49165	6" CP round	1/1

ABS

PART NO.	STRAINER	CTN/MSTR
D49152	4" PB round	1/1
D49154	4" NB round	1/1
D49156	5" PB round	1/1
D49158	5" NB round	1/1
D49160	5" CP round	1/1
D49162	6" PB round	1/1
D49164	6" NB round	1/1
D49166	6" CP round	1/1

3" x 4" Drain Base with 4" Plastic Spud

Fits Over 3" and Inside 4" Schedule 40 DWV Pipe

MADE IN THE
USA

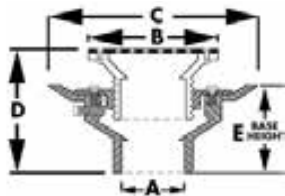

- Completely adjustable; reversible clamping ring gains additional 1" height (Dimension D)
- Strainers are available in SS, PB, NB and CP
- Stainless steel strainers are .06" thick
- PB, NB and CP strainers are 3/16" thick
- 8-1/2" pan primer tapped with 1/2" plug
- Gray PVC or Black ABS
- Extra weep holes

STRAINER	A	B	C	D	E
6" round stainless steel	Over 3" Inside 4"	6-3/16"	8-9/16"	5-1/16" — 6-3/16"	5-1/4"
6" round	Over 3" Inside 4"	6-3/16"	8-9/16"	5-1/8" — 6-3/8"	5-1/4"
6" round with ring	Over 3" Inside 4"	6-7/16"	8-9/16"	5-5/16" — 6-1/2"	5-1/4"

PVC

PART NO.	STRAINER	CTN/MSTR
D49177	6" SS round	1/1
D49179	6" PB round	1/1
D49181	6" PB round with ring	1/1
D49183	6" NB round	1/1
D49185	6" NB round with ring	1/1
D49187	6" CP round	1/1
D49189	6" CP round with ring	1/1

ABS

PART NO.	STRAINER	CTN/MSTR
D49178	6" SS round	1/1
D49180	6" PB round	1/1
D49182	6" PB round with ring	1/1
D49184	6" NB round	1/1
D49186	6" NB round with ring	1/1
D49188	6" CP round	1/1
D49190	6" CP round with ring	1/1

4" Drain Base with 3" Plastic Spud

Fits Over 4" Schedule 40 DWV Pipe

MADE IN THE
USA

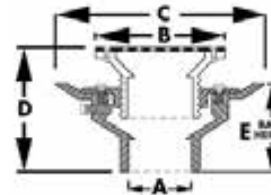

- Completely adjustable; reversible clamping ring gains additional 1" height (Dimension D)
- Strainers are available in SS, PB, NB and CP
- Stainless steel strainers are .06" thick
- PB, NB and CP strainers are 3/16" thick
- 8-1/2" pan primer tapped with 1/2" plug
- Gray PVC or Black ABS
- Extra weep holes

STRAINER	A	B	C	D	E
6" round stainless steel	Over 4"	6-1/8"	8-9/16"	5-9/16" — 6-11/16"	4-1/4"
6" round	Over 4"	6-1/8"	8-9/16"	5-5/8" — 6-7/8"	4-1/4"
6" round with ring	Over 4"	6-7/16"	8-9/16"	5-13/16" — 7"	4-1/4"

PVC

PART NO.	STRAINER	CTN/MSTR
D49201	6" SS round	1/1
D49203	6" PB round	1/1
D49205	6" PB round with ring	1/1
D49207	6" NB round	1/1
D49209	6" NB round with ring	1/1
D49211	6" CP round	1/1
D49213	6" CP round with ring	1/1

ABS

PART NO.	STRAINER	CTN/MSTR
D49202	6" SS round	1/1
D49204	6" PB round	1/1
D49206	6" PB round with ring	1/1
D49208	6" NB round	1/1
D49210	6" NB round with ring	1/1
D49212	6" CP round	1/1
D49214	6" CP round with ring	1/1

3" x 4" Drain Base with 4" Metal Spud

Fits Over 3" and Inside 4" Schedule 40 DWV Pipe

MADE IN THE
USA

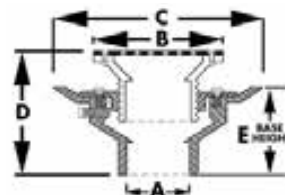

- Completely adjustable; reversible clamping ring gains additional 1" height (Dimension D)
- Strainers are available in PB and NB
- Strainers are 3/16" thick
- 8-1/2" pan primer tapped with 1/2" plug
- Gray PVC or Black ABS
- Extra weep holes

STRAINER	A	B	C	D	E
5" round	Over 3" Inside 4"	5-3/16"	8-9/16"	4-3/16" — 5-3/8"	5-1/4"

PVC

PART NO.	STRAINER	CTN/MSTR
D49195	5" PB round	1/1
D49197	5" NB round	1/1

ABS

PART NO.	STRAINER	CTN/MSTR
D49196	5" PB round	1/1
D49198	5" NB round	1/1

4" Drain Base with 3" Metal Spud

Fits Over 4" Schedule 40 DWV Pipe

MADE IN THE
USA

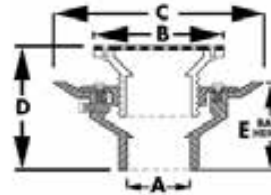

- Completely adjustable; reversible clamping ring gains additional 1" height (Dimension D)
- Strainers are available in PB and NB
- Strainers are 3/16" thick
- 8-1/2" pan primer tapped with 1/2" plug
- Gray PVC or Black ABS
- Extra weep holes

STRAINER	A	B	C	D	E
5" round	Over 4"	5-3/16"	8-9/16"	4-11/16" — 5-7/8"	4-1/4"

PVC

PART NO.	STRAINER	CTN/MSTR
D49219	5" PB round	1/1
D49221	5" NB round	1/1

ABS

PART NO.	STRAINER	CTN/MSTR
D49220	5" PB round	1/1
D49222	5" NB round	1/1

4" Drain Base with 3-1/2" Plastic Spud

Fits Over 4" Schedule 40 DWV Pipe



MADE IN THE
USA

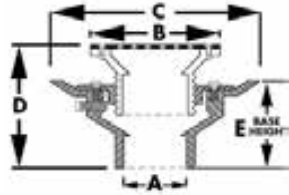

- Completely adjustable; reversible clamping ring gains additional 1" height (Dimension D)
- Strainers are available in SS, PB, NB and CP
- Stainless steel strainers are .06" thick
- PB, NB and CP strainers are 3/16" thick
- 8-1/2" pan primer tapped with 1/2" plug
- Gray PVC or Black ABS
- Extra weep holes

STRAINER	A	B	C	D	E
5" round stainless steel	Over 4"	5-1/4"	8-9/16"	5-1/8" — 6-5/8"	4-1/4"
5" round	Over 4"	5-1/4"	8-9/16"	5-3/16" — 6-3/4"	4-1/4"
5" round with ring	Over 4"	5-9/16"	8-9/16"	5-1/4" — 6-13/16"	4-1/4"
6" round stainless steel	Over 4"	6-1/4"	8-9/16"	5-5/16" — 6-3/4"	4-1/4"
6" round	Over 4"	6-1/4"	8-9/16"	5-7/16" — 6-13/16"	4-1/4"
6" round with ring	Over 4"	6-9/16"	8-9/16"	5-9/16" — 7"	4-1/4"

PVC

PART NO.	STRAINER	CTN/MSTR
D49223	5" SS round	1/1
D49225	5" PB round	1/1
D49227	5" PB round with ring	1/1
D49229	5" NB round	1/1
D49231	5" NB round with ring	1/1
D49233	5" CP round	1/1
D49235	5" CP round with ring	1/1
D49237	6" SS round	1/1
D49239	6" PB round	1/1
D49241	6" PB round with ring	1/1
D49243	6" NB round	1/1
D49245	6" NB round with ring	1/1
D49247	6" CP round	1/1
D49249	6" CP round with ring	1/1

ABS

PART NO.	STRAINER	CTN/MSTR
D49224	5" SS round	1/1
D49226	5" PB round	1/1
D49228	5" PB round with ring	1/1
D49230	5" NB round	1/1
D49232	5" NB round with ring	1/1
D49234	5" CP round	1/1
D49236	5" CP round with ring	1/1
D49238	6" SS round	1/1
D49240	6" PB round	1/1
D49242	6" PB round with ring	1/1
D49244	6" NB round	1/1
D49246	6" NB round with ring	1/1
D49248	6" CP round	1/1
D49250	6" CP round with ring	1/1

4" Drain Base with 3-1/2" Metal Spud

Fits Over 4" Schedule 40 DWV Pipe



MADE IN THE
USA

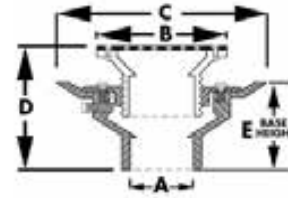

- Completely adjustable; reversible clamping ring gains additional 1" height (Dimension D)
- Strainers are available in PB, NB and CP
- Strainers are 3/16" thick
- 8-1/2" pan primer tapped with 1/2" plug
- Gray PVC or Black ABS
- Extra weep holes

STRAINER	A	B	C	D	E
4" round	Over 4"	4-1/8"	8-9/16"	4-5/8" — 5-3/4"	4-1/4"
5" round	Over 4"	5-3/16"	8-9/16"	4-5/8" — 5-13/16"	4-1/4"
6" round	Over 4"	6-3/16"	8-9/16"	4-13/16" — 6-1/4"	4-1/4"

PVC

PART NO.	STRAINER	CTN/MSTR
D49251	4" PB round	1/1
D49253	4" NB round	1/1
D49255	5" PB round	1/1
D49257	5" NB round	1/1
D49259	5" CP round	1/1
D49261	6" PB round	1/1
D49263	6" NB round	1/1
D49265	6" CP round	1/1

ABS

PART NO.	STRAINER	CTN/MSTR
D49252	4" PB round	1/1
D49254	4" NB round	1/1
D49256	5" PB round	1/1
D49258	5" NB round	1/1
D49260	5" CP round	1/1
D49262	6" PB round	1/1
D49264	6" NB round	1/1
D49266	6" CP round	1/1

4" Drain Base with 4" Plastic Spud

Fits Over 4" Schedule 40 DWV Pipe



MADE IN THE
USA

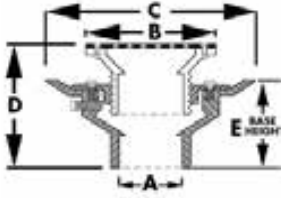

- Completely adjustable; reversible clamping ring gains additional 1" height (Dimension D)
- Strainers are available in SS, PB, NB and CP
- Stainless steel strainers are .06" thick
- PB, NB and CP strainers are 3/16" thick
- 8-1/2" pan primer tapped with 1/2" plug
- Gray PVC or Black ABS
- Extra weep holes

STRAINER	A	B	C	D	E
6" round stainless steel	Over 4"	6-3/16"	8-9/16"	5-1/2" — 6-11/16"	4-1/4"
6" round	Over 4"	6-3/16"	8-9/16"	5-9/16" — 6-3/4"	4-1/4"
6" round with ring	Over 4"	6-7/16"	8-9/16"	5-3/4" — 7"	4-1/4"

PVC

PART NO.	STRAINER	CTN/MSTR
D49277	6" SS round	1/1
D49279	6" PB round	1/1
D49281	6" PB round with ring	1/1
D49283	6" NB round	1/1
D49285	6" NB round with ring	1/1
D49287	6" CP round	1/1
D49289	6" CP round with ring	1/1

ABS

PART NO.	STRAINER	CTN/MSTR
D49278	6" SS round	1/1
D49280	6" PB round	1/1
D49282	6" PB round with ring	1/1
D49284	6" NB round	1/1
D49286	6" NB round with ring	1/1
D49288	6" CP round	1/1
D49290	6" CP round with ring	1/1

4" Drain Base with 4" Metal Spud

Fits Over 4" Schedule 40 DWV Pipe



MADE IN THE
USA

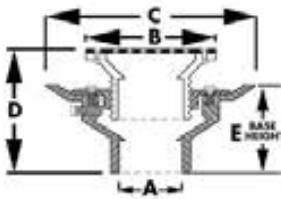

- Completely adjustable; reversible clamping ring gains additional 1" height (Dimension D)
- Strainers are available in PB and NB
- Strainers are 3/16" thick
- 8-1/2" pan primer tapped with 1/2" plug
- Gray PVC or Black ABS
- Extra weep holes

STRAINER	A	B	C	D	E
5" round	Over 4"	5-3/16"	8-9/16"	4-5/8" — 5-11/16"	4-1/4"

PVC

PART NO.	STRAINER	CTN/MSTR
D49295	5" PB round	1/1
D49297	5" NB round	1/1

ABS

PART NO.	STRAINER	CTN/MSTR
D49296	5" PB round	1/1
D49298	5" NB round	1/1

PVC and ABS 8-1/2" Pan Commercial Slab Drains

Pages 205-211

SIZES: 2" x 3", 3" x 4", 4"



For use in applications where a membrane is not required.

2" x 3" Slab Drain Base with 3" Plastic Spud

Fits Over 2" and Inside 3" Schedule 40 DWV Pipe

MADE IN THE
USA

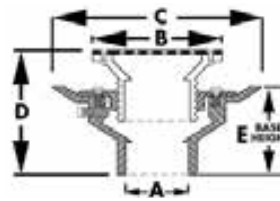

- Completely adjustable (See Dimension D)
- 8-1/2" pan for applications where no clamping ring is required
- Strainers are available in SS, PB, NB and CP
- Stainless steel strainers are .06" thick
- PB, NB and CP strainers are 3/16" thick
- Spud threads directly into base
- Primer tapped with 1/2" plug
- Gray PVC or Black ABS

STRAINER	A	B	C	D	E
6" round stainless steel	Over 2" Inside 3"	6-1/8"	8-9/16"	4-15/16" — 5-7/8"	3-3/4"
6" round	Over 2" Inside 3"	6-1/8"	8-9/16"	5" — 6"	3-3/4"
6" round with ring	Over 2" Inside 3"	6-7/16"	8-9/16"	5-1/8" — 6-1/8"	3-3/4"

PVC

PART NO.	STRAINER	CTN/MSTR
D49301	6" SS round	1/1
D49303	6" PB round	1/1
D49305	6" PB round with ring	1/1
D49307	6" NB round	1/1
D49309	6" NB round with ring	1/1
D49311	6" CP round	1/1
D49313	6" CP round with ring	1/1

ABS

PART NO.	STRAINER	CTN/MSTR
D49302	6" SS round	1/1
D49304	6" PB round	1/1
D49306	6" PB round with ring	1/1
D49308	6" NB round	1/1
D49310	6" NB round with ring	1/1
D49312	6" CP round	1/1
D49314	6" CP round with ring	1/1

2" x 3" Slab Drain Base with 3" Metal Spud

Fits Over 2" and Inside 3" Schedule 40 DWV Pipe

MADE IN THE
USA

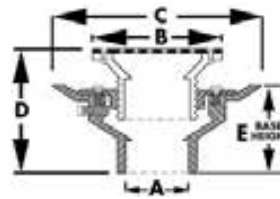

- Completely adjustable (See Dimension D)
- 8-1/2" pan for applications where no clamping ring is required
- Strainers are available in PB and NB
- Strainers are 3/16" thick
- Spud threads directly into base
- Primer tapped with 1/2" plug
- Gray PVC or Black ABS

STRAINER	A	B	C	D	E
5" round	Over 2" Inside 3"	5-3/16"	8-9/16"	3-15/16" — 4-15/16"	3-3/4"

PVC

PART NO.	STRAINER	CTN/MSTR
D49319	5" PB round	1/1
D49321	5" NB round	1/1

ABS

PART NO.	STRAINER	CTN/MSTR
D49320	5" PB round	1/1
D49322	5" NB round	1/1

2" x 3" Slab Drain Base with 3-1/2" Plastic Spud

Fits Over 2" and Inside 3" Schedule 40 DWV Pipe

MADE IN THE
USA

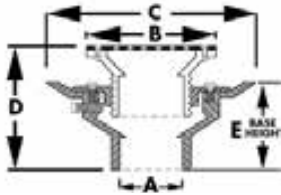

- Completely adjustable (See Dimension D)
- 8-1/2" pan for applications where no clamping ring is required
- Strainers are available in SS, PB, NB and CP
- Stainless steel strainers are .06" thick
- PB, NB and CP strainers are 3/16" thick
- Spud threads directly into base
- Primer tapped with 1/2" plug
- Gray PVC or Black ABS

STRAINER	A	B	C	D	E
5" round stainless steel	Over 2" Inside 3"	5-1/4"	8-9/16"	4-3/4" - 6-1/16"	3-3/4"
5" round	Over 2" Inside 3"	5-1/4"	8-9/16"	5" - 5-15/16"	3-3/4"
5" round with ring	Over 2" Inside 3"	5-9/16"	8-9/16"	5-1/8" - 6-1/8"	3-3/4"
6" round stainless steel	Over 2" Inside 3"	6-1/4"	8-9/16"	5" - 6-1/16"	3-3/4"
6" round	Over 2" Inside 3"	6-1/4"	8-9/16"	5-1/8" - 6"	3-3/4"
6" round with ring	Over 2" Inside 3"	6-9/16"	8-9/16"	5-1/4" - 6-1/4"	3-3/4"

PVC

E

PART NO.	STRAINER	CTN/MSTR
D49323	5" SS round	1/1
D49325	5" PB round	1/1
D49327	5" PB round with ring	1/1
D49329	5" NB round	1/1
D49331	5" NB round with ring	1/1
D49333	5" CP round	1/1
D49335	5" CP round with ring	1/1
D49337	6" SS round	1/1
D49339	6" PB round	1/1
D49341	6" PB round with ring	1/1
D49343	6" NB round	1/1
D49345	6" NB round with ring	1/1
D49349	6" CP round with ring	1/1

ABS

PART NO.	STRAINER	CTN/MSTR
D49324	5" SS round	1/1
D49326	5" PB round	1/1
D49328	5" PB round with ring	1/1
D49330	5" NB round	1/1
D49332	5" NB round with ring	1/1
D49334	5" CP round	1/1
D49336	5" CP round with ring	1/1
D49338	6" SS round	1/1
D49340	6" PB round	1/1
D49342	6" PB round with ring	1/1
D49344	6" NB round	1/1
D49346	6" NB round with ring	1/1
D49348	6" CP round	1/1
D49350	6" CP round with ring	1/1

2" x 3" Slab Drain Base with 3-1/2" Metal Spud

Fits Over 2" and Inside 3" Schedule 40 DWV Pipe

MADE IN THE
USA

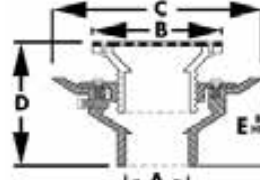

- Completely adjustable (See Dimension D)
- 8-1/2" pan for applications where no clamping ring is required
- Strainers are available in PB, NB and CP
- Strainers are 3/16" thick
- Spud threads directly into base
- Primer tapped with 1/2" plug
- Gray PVC or Black ABS

STRAINER	A	B	C	D	E
4" round	Over 2" Inside 3"	4-1/8"	8-9/16"	4 7/8" - 4-15/16"	3-3/4"
5" round	Over 2" Inside 3"	5-3/16"	8-9/16"	4" - 5"	3-3/4"
6" round	Over 2" Inside 3"	6-3/16"	8-9/16"	4-7/16" - 5-1/2"	3-3/4"

PVC

PART NO.	STRAINER	CTN/MSTR
D49351	4" PB round	1/1
D49353	4" NB round	1/1
D49355	5" PB round	1/1
D49357	5" NB round	1/1
D49359	5" CP round	1/1
D49361	6" PB round	1/1
D49363	6" NB round	1/1
D49365	6" CP round	1/1

ABS

PART NO.	STRAINER	CTN/MSTR
D49352	4" PB round	1/1
D49354	4" NB round	1/1
D49356	5" PB round	1/1
D49358	5" NB round	1/1
D49360	5" CP round	1/1
D49362	6" PB round	1/1
D49364	6" NB round	1/1
D49366	6" CP round	1/1

2"x 3" Slab Drain Base with 4" Plastic Spud

Fits Over 2" and Inside 3" Schedule 40 DWV Pipe

MADE IN THE
USA

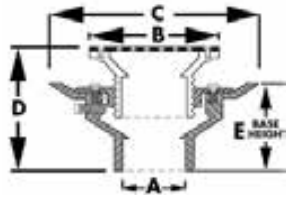

- Completely adjustable (See Dimension D)
- 8-1/2" pan for applications where no clamping ring is required
- Strainers are available in SS, PB, NB and CP
- Stainless steel strainers are .06" thick
- PB, NB and CP strainers are 3/16" thick
- Spud threads directly into base
- Primer tapped with 1/2" plug
- Gray PVC or Black ABS

STRAINER	A	B	C	D	E
6" round stainless steel	Over 2" Inside 3"	6-3/16"	8-9/16"	5" - 5-15/16"	3-3/4"
6" round	Over 2" Inside 3"	6-3/16"	8-9/16"	5" - 6"	3-3/4"
6" round with ring	Over 2" Inside 3"	6-7/16"	8-9/16"	5-3/16" - 6-3/16"	3-3/4"

PVC

PART NO.	STRAINER	CTN/MSTR
D49377	6" SS round	1/1
D49379	6" PB round	1/1
D49381	6" PB round with ring	1/1
D49383	6" NB round	1/1
D49385	6" NB round with ring	1/1
D49387	6" CP round	1/1
D49389	6" CP round with ring	1/1

ABS

PART NO.	STRAINER	CTN/MSTR
D49378	6" SS round	1/1
D49380	6" PB round	1/1
D49382	6" PB round with ring	1/1
D49384	6" NB round	1/1
D49386	6" NB round with ring	1/1
D49388	6" CP round	1/1
D49390	6" CP round with ring	1/1

2"x 3" Slab Drain Base with 4" Metal Spud

Fits Over 2" and Inside 3" Schedule 40 DWV Pipe

MADE IN THE
USA

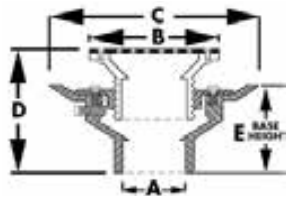

- Completely adjustable (See Dimension D)
- 8-1/2" pan for applications where no clamping ring is required
- Strainers are available in PB and NB
- Strainers are 3/16" thick
- Spud threads directly into base
- Primer tapped with 1/2" plug
- Gray PVC or Black ABS

STRAINER	A	B	C	D	E
5" round	Over 2" Inside 3"	5-3/16"	8-9/16"	3-7/8" - 4-7/8"	3-3/4"

PVC

PART NO.	STRAINER	CTN/MSTR
D49395	5" PB round	1/1
D49397	5" NB round	1/1

ABS

PART NO.	STRAINER	CTN/MSTR
D49396	5" PB round	1/1
D49398	5" NB round	1/1

3"x 4" Slab Drain Base with 3" Plastic Spud

Fits Over 3" and Inside 4" Schedule 40 DWV Pipe

MADE IN THE
USA

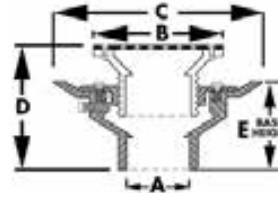

- Completely adjustable (See Dimension D)
- 8-1/2" pan for applications where no clamping ring is required
- Strainers are available in SS, PB, NB and CP
- Stainless steel strainers are .06" thick
- PB, NB and CP strainers are 3/16" thick
- Spud threads directly into base
- Primer tapped with 1/2" plug
- Gray PVC or Black ABS

STRAINER	A	B	C	D	E
6" round stainless steel	Over 3" Inside 4"	6-1/8"	8-9/16"	5-1/16" - 6-1/16"	3-3/4"
6" round	Over 3" Inside 4"	6-1/8"	8-9/16"	5-1/8" - 6-3/16"	3-3/4"
6" round with ring	Over 3" Inside 4"	6-7/16"	8-9/16"	5-5/16" - 6-3/8"	3-3/4"

PVC

PART NO.	STRAINER	CTN/MSTR
D49401	6" SS round	1/1
D49403	6" PB round	1/1
D49405	6" PB round with ring	1/1
D49407	6" NB round	1/1
D49411	6" CP round	1/1
D49413	6" CP round with ring	1/1

ABS

PART NO.	STRAINER	CTN/MSTR
D49402	6" SS round	1/1
D49404	6" PB round	1/1
D49406	6" PB round with ring	1/1
D49408	6" NB round	1/1
D49410	6" NB round with ring	1/1
D49412	6" CP round	1/1
D49414	6" CP round with ring	1/1

3"x 4" Slab Drain Base with 3" Metal Spud

Fits Over 3" and Inside 4" Schedule 40 DWV Pipe

MADE IN THE
USA

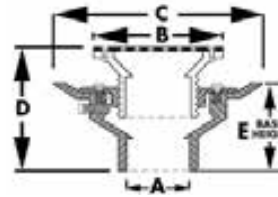

- Completely adjustable (See Dimension D)
- 8-1/2" pan for applications where no clamping ring is required
- Strainers are available in PB and NB
- Strainers are 3/16" thick
- Spud threads directly into base
- Primer tapped with 1/2" plug
- Gray PVC or Black ABS

STRAINER	A	B	C	D	E
5" round	Over 3" Inside 4"	5-3/16"	8-9/16"	4-1/8" - 5-1/8"	3-3/4"

PVC

PART NO.	STRAINER	CTN/MSTR
D49419	5" PB round	1/1
D49421	5" NB round	1/1

ABS

PART NO.	STRAINER	CTN/MSTR
D49420	5" PB round	1/1
D49422	5" NB round	1/1

3"x 4" Slab Drain Base with 3-1/2" Plastic Spud

Fits Over 3" and Inside 4" Schedule 40 DWV Pipe

MADE IN THE
USA

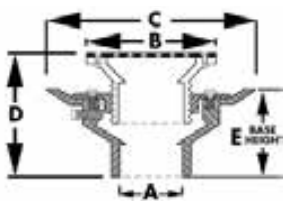

- Completely adjustable (See Dimension D)
- 8-1/2" pan for applications where no clamping ring is required
- Strainers are available in SS, PB, NB and CP
- Stainless steel strainers are .06" thick
- PB, NB and CP strainers are 3/16" thick
- Spud threads directly into base
- Primer tapped with 1/2" plug
- Gray PVC or Black ABS

STRAINER	A	B	C	D	E
5" round stainless steel	Over 3" Inside 4"	5-1/4"	8-9/16"	5" — 6-1/8"	3-3/4"
5" round	Over 3" Inside 4"	5-1/4"	8-9/16"	5-3/16" — 6-3/16"	3-3/4"
5" round with ring	Over 3" Inside 4"	5-9/16"	8-9/16"	5-3/8" — 6-5/16"	3-3/4"
6" round stainless steel	Over 3" Inside 4"	6-1/4"	8-9/16"	5-1/16" — 6-1/16"	3-3/4"
6" round	Over 3" Inside 4"	6-1/4"	8-9/16"	5-3/16" — 6-3/16"	3-3/4"
6" round with ring	Over 3" Inside 4"	6-9/16"	8-9/16"	5-5/16" — 6-3/8"	3-3/4"

PVC

PART NO.	STRAINER	CTN/MSTR
D49423	5" SS round	1/1
D49425	5" PB round	1/1
D49427	5" PB round with ring	1/1
D49429	5" NB round	1/1
D49431	5" NB round with ring	1/1
D49433	5" CP round	1/1
D49435	5" CP round with ring	1/1
D49437	6" SS round	1/1
D49439	6" PB round	1/1
D49441	6" PB round with ring	1/1
D49443	6" NB round	1/1
D49445	6" NB round with ring	1/1
D49447	6" CP round	1/1
D49449	6" CP round with ring	1/1

ABS

PART NO.	STRAINER	CTN/MSTR
D49424	5" SS round	1/1
D49426	5" PB round	1/1
D49428	5" PB round with ring	1/1
D49430	5" NB round	1/1
D49432	5" NB round with ring	1/1
D49434	5" CP round	1/1
D49436	5" CP round with ring	1/1
D49438	6" SS round	1/1
D49440	6" PB round	1/1
D49442	6" PB round with ring	1/1
D49444	6" NB round	1/1
D49446	6" NB round with ring	1/1
D49448	6" CP round	1/1
D49450	6" CP round with ring	1/1

3"x 4" Slab Drain Base with 3-1/2" Metal Spud

Fits Over 3" and Inside 4" Schedule 40 DWV Pipe

MADE IN THE
USA

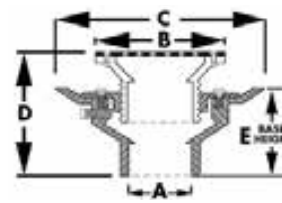

- Completely adjustable (See Dimension D)
- 8-1/2" pan for applications where no clamping ring is required
- Strainers are available in PB, NB and CP
- Strainers are 3/16" thick
- Spud threads directly into base
- Primer tapped with 1/2" plug
- Gray PVC or Black ABS

STRAINER	A	B	C	D	E
4" round	Over 3" Inside 4"	4-1/8"	8-9/16"	4-1/8" — 5-1/16"	3-15/16"
5" round	Over 3" Inside 4"	5-3/16"	8-9/16"	4-1/8" — 5-1/4"	3-15/16"
6" round	Over 3" Inside 4"	6-3/16"	8-9/16"	4-9/16" — 5-7/16"	3-15/16"
8" round	Over 3" Inside 4"	8-1/8"	8-9/16"	5-1/16" — 6"	3-15/16"
9" round	Over 3" Inside 4"	9"	8-9/16"	5" — 6-1/8"	3-15/16"

PVC

PART NO.	STRAINER	CTN/MSTR
D49451	4" PB round	1/1
D49453	4" NB round	1/1
D49455	5" PB round	1/1
D49457	5" NB round	1/1
D49459	5" CP round	1/1
D49461	6" PB round	1/1
D49463	6" NB round	1/1
D49465	6" CP round	1/1
D49467	8" PB round	1/1
D49469	8" NB round	1/1
D49473	9" PB round	1/1
D49475	9" NB round	1/1

ABS

PART NO.	STRAINER	CTN/MSTR
D49452	4" PB round	1/1
D49454	4" NB round	1/1
D49456	5" PB round	1/1
D49458	5" NB round	1/1
D49460	5" CP round	1/1
D49462	6" PB round	1/1
D49464	6" NB round	1/1
D49466	6" CP round	1/1
D49468	8" PB round	1/1
D49470	8" NB round	1/1
D49474	9" PB round	1/1
D49476	9" NB round	1/1

3" x 4" Slab Drain Base with 4" Plastic Spud

Fits Over 3" and Inside 4" Schedule 40 DWV Pipe

MADE IN THE USA

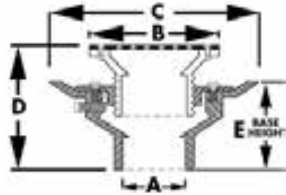

- Completely adjustable (See Dimension D)
- 8-1/2" pan for applications where no clamping ring is required
- Strainers are available in SS, PB, NB and CP
- Stainless steel strainers are .06" thick
- PB, NB and CP strainers are 3/16" thick
- Spud threads directly into base
- Primer tapped with 1/2" plug
- Gray PVC or Black ABS

STRAINER	A	B	C	D	E
6" round stainless steel	Over 3" Inside 4"	6-3/16"	8-9/16"	5-1/16" - 6-1/8"	3-15/16"
6" round	Over 3" Inside 4"	6-3/16"	8-9/16"	5-1/4" - 6-3/16"	3-15/16"
6" round with ring	Over 3" Inside 4"	6-7/16"	8-9/16"	5-3/8" - 6-5/16"	3-15/16"

PVC

PART NO.	STRAINER	CTN/MSTR
D49477	6" SS round	1/1
D49479	6" PB round	1/1
D49481	6" PB round with ring	1/1
D49483	6" NB round	1/1
D49485	6" NB round with ring	1/1
D49487	6" CP round	1/1
D49489	6" CP round with ring	1/1

ABS

PART NO.	STRAINER	CTN/MSTR
D49478	6" SS round	1/1
D49480	6" PB round	1/1
D49482	6" PB round with ring	1/1
D49484	6" NB round	1/1
D49486	6" NB round with ring	1/1
D49488	6" CP round	1/1
D49490	6" CP round with ring	1/1

3" x 4" Slab Drain Base with 4" Metal Spud

Fits Over 3" and Inside 4" Schedule 40 DWV Pipe

MADE IN THE USA

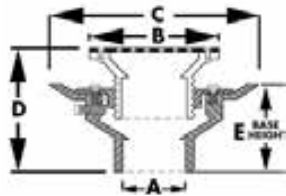

- Completely adjustable (See Dimension D)
- 8-1/2" pan for applications where no clamping ring is required
- Strainers are available in PB and NB
- Strainers are 3/16" thick
- Spud threads directly into base
- Primer tapped with 1/2" plug
- Gray PVC or Black ABS

STRAINER	A	B	C	D	E
5" round	Over 3" Inside 4"	5-3/16"	8-9/16"	4" - 5-1/8"	3-15/16"

PVC

PART NO.	STRAINER	CTN/MSTR
D49495	5" PB round	1/1
D49497	5" NB round	1/1

ABS

PART NO.	STRAINER	CTN/MSTR
D49496	5" PB round	1/1
D49498	5" NB round	1/1

4" Slab Drain Base with 3" Plastic Spud

Fits Over 4" Schedule 40 DWV Pipe

MADE IN THE USA

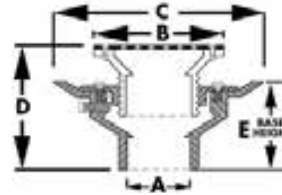

- Completely adjustable (See Dimension D)
- 8-1/2" pan for applications where no clamping ring is required
- Strainers are available in SS, PB, NB and CP
- Stainless steel strainers are .06" thick
- PB, NB and CP strainers are 3/16" thick
- Spud threads directly into base
- Primer tapped with 1/2" plug
- Gray PVC or Black ABS

STRAINER	A	B	C	D	E
6" round stainless steel	Over 4"	6-1/8"	8-9/16"	5-5/16" - 6-3/8"	4-3/16"
6" round	Over 4"	6-1/8"	8-9/16"	5-3/8" - 6-5/16"	4-3/16"
6" round with ring	Over 4"	6-7/16"	8-9/16"	5-1/8" - 6-9/16"	4-3/16"

PVC

PART NO.	STRAINER	CTN/MSTR
D49501	6" SS round	1/1
D49503	6" PB round	1/1
D49505	6" PB round with ring	1/1
D49507	6" NB round	1/1
D49509	6" NB round with ring	1/1
D49511	6" CP round	1/1
D49513	6" CP round with ring	1/1

ABS

PART NO.	STRAINER	CTN/MSTR
D49502	6" SS round	1/1
D49504	6" PB round	1/1
D49506	6" PB round with ring	1/1
D49508	6" NB round	1/1
D49510	6" NB round with ring	1/1
D49512	6" CP round	1/1
D49514	6" CP round with ring	1/1

4" Slab Drain Base with 3" Metal Spud

Fits Over 4" Schedule 40 DWV Pipe

MADE IN THE USA

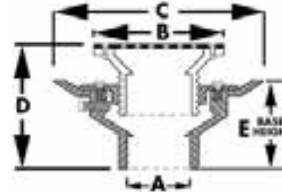

- Completely adjustable (See Dimension D)
- 8-1/2" pan for applications where no clamping ring is required
- Strainers are available in PB and NB
- Strainers are 3/16" thick
- Spud threads directly into base
- Primer tapped with 1/2" plug
- Gray PVC or Black ABS

STRAINER	A	B	C	D	E
5" round	Over 4"	5-3/16"	8-9/16"	4-5/16" - 5-3/8"	4-3/16"

PVC

PART NO.	STRAINER	CTN/MSTR
D49519	5" PB round	1/1
D49521	5" NB round	1/1

ABS

PART NO.	STRAINER	CTN/MSTR
D49520	5" PB round	1/1
D49522	5" NB round	1/1

4" Slab Drain Base with 3-1/2" Plastic Spud

Fits Over 4" Schedule 40 DWV Pipe

MADE IN THE
USA

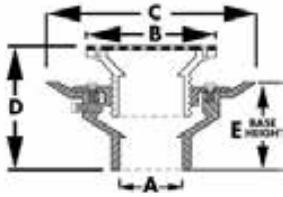

- Completely adjustable (See Dimension D)
- 8-1/2" pan for applications where no clamping ring is required
- Strainers are available in SS, PB, NB and CP
- Stainless steel strainers are .06" thick
- PB, NB and CP strainers are 3/16" thick
- Spud threads directly into base
- Primer tapped with 1/2" plug
- Gray PVC or Black ABS

STRAINER	A	B	C	D	E
5" round stainless steel	Over 4"	5-1/4"	8-9/16"	5-1/4" - 6-7/16"	4-3/16"
5" round	Over 4"	5-1/4"	8-9/16"	5-3/8" - 6-7/16"	4-3/16"
5" round with ring	Over 4"	5-9/16"	8-9/16"	5-9/16" - 6-5/8"	4-3/16"
6" round stainless steel	Over 4"	6-1/4"	8-9/16"	5-3/8" - 6-7/16"	4-3/16"
6" round	Over 4"	6-1/4"	8-9/16"	5-7/16" - 6-7/16"	4-3/16"
6" round with ring	Over 4"	6-9/16"	8-9/16"	5-1/2" - 6-5/8"	4-3/16"

PVC

E

PART NO.	STRAINER	CTN/MSTR
D49523	5" SS round	1/1
D49525	5" PB round	1/1
D49527	5" PB round with ring	1/1
D49529	5" NB round	1/1
D49531	5" NB round with ring	1/1
D49533	5" CP round	1/1
D49535	5" CP round with ring	1/1
D49537	6" SS round	1/1
D49539	6" PB round	1/1
D49541	6" PB round with ring	1/1
D49543	6" NB round	1/1
D49545	6" NB round with ring	1/1
D49547	6" CP round	1/1
D49549	6" CP round with ring	1/1

ABS

PART NO.	STRAINER	CTN/MSTR
D49524	5" SS round	1/1
D49526	5" PB round	1/1
D49528	5" PB round with ring	1/1
D49530	5" NB round	1/1
D49532	5" NB round with ring	1/1
D49534	5" CP round	1/1
D49536	5" CP round with ring	1/1
D49538	6" SS round	1/1
D49540	6" PB round	1/1
D49542	6" PB round with ring	1/1
D49544	6" NB round	1/1
D49546	6" NB round with ring	1/1
D49548	6" CP round	1/1
D49550	6" CP round with ring	1/1

4" Slab Drain Base with 3-1/2" Metal Spud

Fits Over 4" Schedule 40 DWV Pipe

MADE IN THE
USA

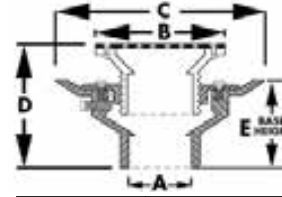

- Completely adjustable (See Dimension D)
- 8-1/2" pan for applications where no clamping ring is required
- Strainers are available in PB, NB and CP
- Strainers are 3/16" thick
- Spud threads directly into base
- Primer tapped with 1/2" plug
- Gray PVC or Black ABS

STRAINER	A	B	C	D	E
4" round	Over 4"	4-1/8"	8-9/16"	4-7/16" - 5-7/16"	4-3/16"
5" round	Over 4"	5-3/16"	8-9/16"	4-5/16" - 5-7/16"	4-3/16"
6" round	Over 4"	6-3/16"	8-9/16"	4-13/16" - 5-13/16"	4-3/16"

PVC

PART NO.	STRAINER	CTN/MSTR
D49551	4" PB round	1/1
D49553	4" NB round	1/1
D49555	5" PB round	1/1
D49557	5" NB round	1/1
D49559	5" CP round	1/1
D49561	6" PB round	1/1
D49563	6" NB round	1/1
D49565	6" CP round	1/1

ABS

PART NO.	STRAINER	CTN/MSTR
D49552	4" PB round	1/1
D49554	4" NB round	1/1
D49556	5" PB round	1/1
D49558	5" NB round	1/1
D49560	5" CP round	1/1
D49562	6" PB round	1/1
D49564	6" NB round	1/1
D49566	6" CP round	1/1

4" Slab Drain Base with 4" Plastic Spud

Fits Over 4" Schedule 40 DWV Pipe



MADE IN THE
USA

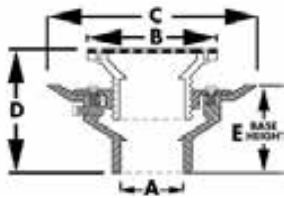

- Completely adjustable (See Dimension D)
- 8-1/2" pan for applications where no clamping ring is required
- Strainers are available in SS, PB, NB and CP
- Stainless steel strainers are .06" thick
- PB, NB and CP strainers are 3/16" thick
- Spud threads directly into base
- Primer tapped with 1/2" plug
- Gray PVC or Black ABS

STRAINER	A	B	C	D	E
6" round stainless steel	Over 4"	6-3/16"	8-9/16"	5-3/8" - 6-3/8"	4-3/16"
6" round	Over 4"	6-3/16"	8-9/16"	5-7/16" - 6-7/16"	4-3/16"
6" round with ring	Over 4"	6-7/16"	8-9/16"	5-5/8" - 6-9/16"	4-3/16"

PVC

PART NO.	STRAINER	CTN/MSTR
D49577	6" SS round	1/1
D49579	6" PB round	1/1
D49581	6" PB round with ring	1/1
D49583	6" NB round	1/1
D49585	6" NB round with ring	1/1
D49587	6" CP round	1/1
D49589	6" CP round with ring	1/1

ABS

PART NO.	STRAINER	CTN/MSTR
D49578	6" SS round	1/1
D49580	6" PB round	1/1
D49582	6" PB round with ring	1/1
D49584	6" NB round	1/1
D49586	6" NB round with ring	1/1
D49588	6" CP round	1/1
D49590	6" CP round with ring	1/1

4" Slab Drain Base with 4" Metal Spud

Fits Over 4" Schedule 40 DWV Pipe



MADE IN THE
USA

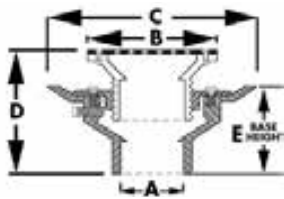

- Completely adjustable (See Dimension D)
- 8-1/2" pan for applications where no clamping ring is required
- Strainers are available in PB and NB
- Strainers are 3/16" thick
- Spud threads directly into base
- Primer tapped with 1/2" plug
- Gray PVC or Black ABS

STRAINER	A	B	C	D	E
5" round	Over 4"	5-3/16"	8-9/16"	4-1/4" - 5-5/16"	4-3/16"

PVC

PART NO.	STRAINER	CTN/MSTR
D49595	5" PB round	1/1
D49597	5" NB round	1/1

ABS

PART NO.	STRAINER	CTN/MSTR
D49596	5" PB round	1/1
D49598	5" NB round	1/1

PVC and ABS 10" Pan Commercial Drains

Pages 212-216

SIZES: 2", 3", 4"



For use in applications where a membrane is required.

2" Heavy Duty Drain Base with 3-1/2" Plastic Spud

Fits Over 2" Schedule 40 DWV Pipe

MADE IN THE
USA

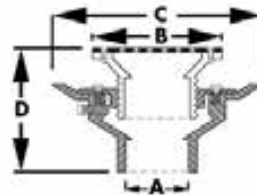

- 10" Pan
- Strainers are available in SS, PB, NB and CP
- Stainless steel strainers are .06" thick
- PB, NB and CP strainers are 3/16" thick
- Primer tapped with 1/2" plug
- Adjustable (see dimension D)

STRAINER	A	B	C	D
5" round	Over 2"	5-3/16"	11"	4-3/8" - 6"
5" round with ring	Over 2"	5-1/2"	11"	4-1/2" - 6-1/8"
6" round	Over 2"	6-1/8"	11"	4-7/16" - 6-1/16"
6" round with ring	Over 2"	6-1/2"	11"	4-1/2" - 6-1/4"

PVC

PART NO.	STRAINER	CTN/MSTR
D53442	5" SS round	1/1
D53443	5" PB round	1/1
D53444	5" PB round with ring	1/1
D53445	5" NB round	1/1
D53446	5" NB round with ring	1/1
D53447	5" CP round	1/1
D53448	5" CP round with ring	1/1
D50037	6" SS round	1/1
D50044	6" PB round	1/1
D50050	6" PB round with ring	1/1
D50047	6" NB round	1/1
D50053	6" NB round with ring	1/1
D50278	6" CP round with ring	1/1

ABS

PART NO.	STRAINER	CTN/MSTR
D53449	5" SS round	1/1
D53450	5" PB round	1/1
D53451	5" PB round with ring	1/1
D53452	5" NB round	1/1
D53453	5" NB round with ring	1/1
D53454	5" CP round	1/1
D53455	5" CP round with ring	1/1
D51037	6" SS round	1/1
D51044	6" PB round	1/1
D51050	6" PB round with ring	1/1
D51047	6" NB round	1/1
D51053	6" NB round with ring	1/1
D51040	6" CP round	1/1
D51278	6" CP round with ring	1/1

2" Heavy Duty Drain Base with 3-1/2" Metal Spud

Fits Over 2" Schedule 40 DWV Pipe

MADE IN THE USA

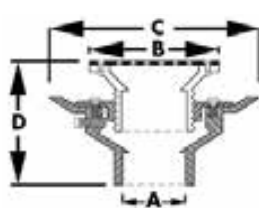

- 10" Pan
- Strainers are available in PB, NB and CP
- PB, NB and CP strainers are 3/16" thick
- Primer tapped with 1/2" plug
- Adjustable (see dimension D)

STRAINER	A	B	C	D
5" or 6" round	Over 2"	5" or 6"	11"	4-1/4" - 5-5/8"
5" or 6" square	Over 2"	5" or 6"	11"	4-1/4" - 5-5/8"

PVC

PART NO.	STRAINER	CTN/MSTR
D50027	5" PB round	1/1
D50060	5" NB round	1/1
D50022	5" CP round	1/1
D50028	6" PB round	1/1
D50063	6" NB round	1/1
D50023	6" CP round	1/1
D50066	5" PB square	1/1
D50072	5" NB square	1/1
D50069	6" PB square	1/1
D50075	6" NB square	1/1

ABS

PART NO.	STRAINER	CTN/MSTR
D51027	5" PB round	1/1
D51060	5" NB round	1/1
D51022	5" CP round	1/1
D51028	6" PB round	1/1
D51063	6" NB round	1/1
D51023	6" CP round	1/1
D51066	5" PB square	1/1
D51072	5" NB square	1/1
D51069	6" PB square	1/1
D51075	6" NB square	1/1

2" Heavy Duty Drain Base with 4" Plastic Spud

Fits Over 2" Schedule 40 DWV Pipe

MADE IN THE USA

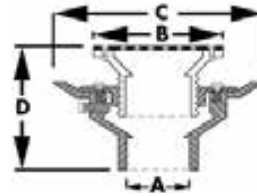

- 10" Pan
- Strainers are available in SS, PB, NB and CP
- Stainless steel strainers are .06" thick
- PB, NB and CP strainers are 3/16" thick
- Primer tapped with 1/2" plug
- Adjustable (see dimension D)

STRAINER	A	B	C	D
6" round	Over 2"	6-1/8"	11"	4-7/16" - 6-1/16"
6" round with ring	Over 2"	6-1/2"	11"	4-1/2" - 6-1/4"

PVC

PART NO.	STRAINER	CTN/MSTR
D50340	6" SS round	1/1
D50341	6" PB round	1/1
D50342	6" PB round with ring	1/1
D50343	6" NB round	1/1
D50345	6" CP round	1/1
D50346	6" CP round with ring	1/1

ABS

PART NO.	STRAINER	CTN/MSTR
D51340	6" SS round	1/1
D51341	6" PB round	1/1
D51342	6" PB round with ring	1/1
D51343	6" NB round	1/1
D51344	6" NB round with ring	1/1
D51345	6" CP round	1/1
D51346	6" CP round with ring	1/1

2" Heavy Duty Drain Base with 4" Metal Spud

Fits Over 2" Schedule 40 DWV Pipe

MADE IN THE USA

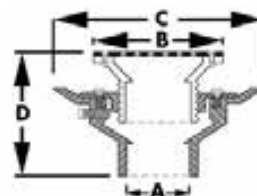

- 10" Pan
- Strainers are available in PB and NB
- Strainers are 3/16" thick
- Primer tapped with 1/2" plug
- Adjustable (see dimension D)

STRAINER	A	B	C	D
5" round	Over 2"	5"	11"	4-1/4" - 5-5/8"

PVC

PART NO.	STRAINER	CTN/MSTR
D50349	5" NB round	1/1
D50350	5" PB round	1/1

ABS

PART NO.	STRAINER	CTN/MSTR
D51349	5" NB round	1/1
D51350	5" PB round	1/1

3" Heavy Duty Drain Base with 3-1/2" Plastic Spud

Fits Over 3" Schedule 40 DWV Pipe

MADE IN THE USA

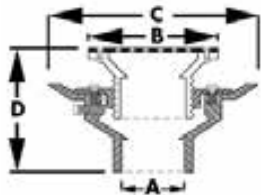

- 10" Pan
- Strainers are available in SS, PB, NB and CP
- Stainless steel strainers are .06" thick
- PB, NB and CP strainers are 3/16" thick
- Primer tapped with 1/2" plug
- Adjustable (see dimension D)

STRAINER	A	B	C	D
5" round	Over 3"	5-3/16"	11"	4-3/8" - 6"
5" round with ring	Over 3"	5-1/2"	11"	4-1/2" - 6-1/8"
6" round	Over 3"	6-1/8"	11"	4-11/16" - 6-7/16"
6" round with ring	Over 3"	6-1/2"	11"	4-3/4" - 6-1/2"

PVC

PART NO.	STRAINER	CTN/MSTR
D53457	5" PB round	1/1
D53458	5" PB round with ring	1/1
D53459	5" NB round	1/1
D53460	5" NB round with ring	1/1
D53461	5" CP round	1/1
D53462	5" CP round with ring	1/1
D50038	6" SS round	1/1
D50045	6" PB round	1/1
D50051	6" PB round with ring	1/1
D50048	6" NB round	1/1
D50054	6" NB round with ring	1/1
D50041	6" CP round	1/1
D50279	6" CP round with ring	1/1

ABS

PART NO.	STRAINER	CTN/MSTR
D53463	5" SS round	1/1
D53464	5" PB round	1/1
D53465	5" PB round with ring	1/1
D53466	5" NB round	1/1
D53467	5" NB round with ring	1/1
D53468	5" CP round	1/1
D53469	5" CP round with ring	1/1
D51038	6" SS round	1/1
D51045	6" PB round	1/1
D51051	6" PB round with ring	1/1
D51048	6" NB round	1/1
D51054	6" NB round with ring	1/1
D51041	6" CP round	1/1
D51279	6" CP round with ring	1/1

3" Heavy Duty Drain Base with 3-1/2" Metal Spud

Fits Over 3" Schedule 40 DWV Pipe

MADE IN THE USA

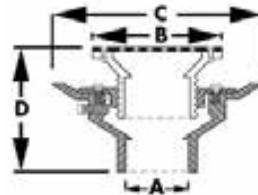

- 10" Pan
- Strainers are available in PB, NB and CP
- Strainers are 3/16" thick
- Primer tapped with 1/2" plug
- Adjustable (see dimension D)

STRAINER	A	B	C	D
5", 6", 8" or 9" round	Over 3"	5", 6", 8" or 9"	11"	5" - 6-1/2"
5" or 6" square	Over 3"	5" or 6"	11"	5" - 6-1/2"

PVC

PART NO.	STRAINER	CTN/MSTR
D50012	5" PB round	1/1
D50061	5" NB round	1/1
D50013	6" PB round	1/1
D50064	6" NB round	1/1
D50005	6" CP round	1/1
D50014	8" PB round	1/1
D53144	8" NB round	1/1
D53148	9" PB round	1/1
D53146	9" NB round	1/1
D50067	5" PB square	1/1
D50073	5" NB square	1/1
D50070	6" PB square	1/1
D50076	6" NB square	1/1

ABS

PART NO.	STRAINER	CTN/MSTR
D51012	5" PB round	1/1
D51061	5" NB round	1/1
D51004	5" CP round	1/1
D51013	6" PB round	1/1
D51064	6" NB round	1/1
D51005	6" CP round	1/1
D51014	8" PB round	1/1
D53145	8" NB round	1/1
D53149	9" PB round	1/1
D53147	9" NB round	1/1
D51067	5" PB square	1/1
D51073	5" NB square	1/1
D51070	6" PB square	1/1
D51076	6" NB square	1/1

Items marked with the Jones Stephens logo are "You Need It... We Got It" Items.

3" Heavy Duty Drain Base with 4" Plastic Spud

Fits Over 3" Schedule 40 DWV Pipe

MADE IN THE USA

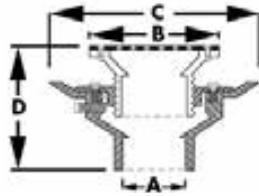

- 10" Pan
- Strainers are available in SS, PB, NB and CP
- Stainless steel strainers are .06" thick
- PB, NB and CP strainers are 3/16" thick
- Primer tapped with 1/2" plug
- Adjustable (see dimension D)

STRAINER	A	B	C	D
6" round	Over 3"	6-1/8"	4-5/8" - 6"	4-11/16" - 6-7/16"
6" round with ring	Over 3"	6-1/2"	4-5/8" - 6"	4-3/4" - 6-1/2"

PVC

PART NO.	STRAINER	CTN/MSTR
D50351	6" SS round	1/1
D50352	6" PB round	1/1
D50353	6" PB round with ring	1/1
D50354	6" NB round	1/1

ABS

PART NO.	STRAINER	CTN/MSTR
D51351	6" SS round	1/1
D51352	6" PB round	1/1
D51353	6" PB round with ring	1/1
D51354	6" NB round	1/1
D51355	6" NB round with ring	1/1
D51356	6" CP round	1/1
D51357	6" CP round with ring	1/1

3" Heavy Duty Drain Base with 4" Metal Spud

Fits Over 3" Schedule 40 DWV Pipe

MADE IN THE USA

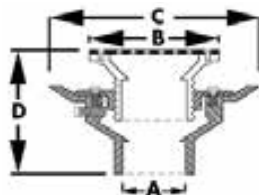

- 10" Pan
- Strainers are available in PB and NB
- Strainers are 3/16" thick
- Primer tapped with 1/2" plug
- Adjustable (see dimension D)

STRAINER	A	B	C	D
5" round	Over 3"	5"	4-5/8" - 6"	5" - 6-1/2"

PVC

PART NO.	STRAINER	CTN/MSTR
D50361	5" PB round	1/1
D50360	5" NB round	1/1

ABS

PART NO.	STRAINER	CTN/MSTR
D51361	5" PB round	1/1
D51360	5" NB round	1/1

4" Heavy Duty Drain Base with 3-1/2" Plastic Spud

Fits Over 4" Schedule 40 DWV Pipe

MADE IN THE USA

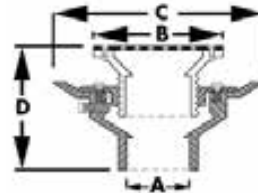

- 10" Pan
- Strainers are available in SS, PB, NB and CP
- Stainless steel strainers are .06" thick
- PB, NB and CP strainers are 3/16" thick
- Primer tapped with 1/2" plug
- Adjustable (see dimension D)

STRAINER	A	B	C	D
5" round	Over 4"	5-3/16"	11"	4-3/8" - 6"
5" round with ring	Over 4"	5-1/2"	11"	4-1/2" - 6-1/8"
6" round	Over 4"	6-1/8"	11"	5-1/16" - 6-13/16"
6" round with ring	Over 4"	6-1/2"	11"	5-1/4" - 6-15/16"

PVC

PART NO.	STRAINER	CTN/MSTR
D53470	5" SS round	1/1
D53471	5" PB round	1/1
D53472	5" PB round with ring	1/1
D53473	5" NB round	1/1
D53474	5" NB round with ring	1/1
D53475	5" CP round	1/1
D53476	5" CP round with ring	1/1
D50039	6" SS round	1/1
D50046	6" PB round	1/1
D50052	6" PB round with ring	1/1
D50049	6" NB round	1/1
D50280	6" CP round with ring	1/1

ABS

PART NO.	STRAINER	CTN/MSTR
D53477	5" SS round	1/1
D53478	5" PB round	1/1
D53479	5" PB round with ring	1/1
D53480	5" NB round	1/1
D53481	5" NB round with ring	1/1
D53482	5" CP round	1/1
D53483	5" CP round with ring	1/1
D51039	6" SS round	1/1
D51046	6" PB round	1/1
D51052	6" PB round with ring	1/1
D51049	6" NB round	1/1
D51055	6" NB round with ring	1/1
D51042	6" CP round	1/1
D51280	6" CP round with ring	1/1

4" Heavy Duty Drain Base with 3-1/2" Metal Spud

Fits Over 4" Schedule 40 DWV Pipe

MADE IN THE USA

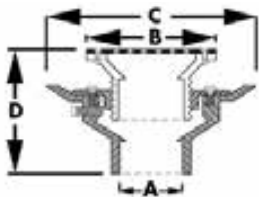

- 10" Pan
- Strainers are available in PB, NB and CP
- Strainers are 3/16" thick
- Primer tapped with 1/2" plug
- Adjustable (see dimension D)

STRAINER	A	B	C	D
5" or 6" round	Over 4"	5" or 6"	11"	4-5/8" - 5-7/8"
5" or 6" square	Over 4"	5" or 6"	11"	4-5/8" - 5-7/8"

PVC

PART NO.	STRAINER	CTN/MSTR
D50062	5" NB round	1/1
D50015	5" PB round	1/1
D50065	6" NB round	1/1
D50016	6" PB round	1/1
D50008	6" CP round	1/1
D50068	5" PB square	1/1
D50074	5" NB square	1/1
D50071	6" PB square	1/1
D50077	6" NB square	1/1

ABS

PART NO.	STRAINER	CTN/MSTR
D51062	5" NB round	1/1
D51015	5" PB round	1/1
D51007	5" CP round	1/1
D51065	6" NB round	1/1
D51016	6" PB round	1/1
D51008	6" CP round	1/1
D51068	5" PB square	1/1
D51074	5" NB square	1/1
D51071	6" PB square	1/1
D51077	6" NB square	1/1

4" Heavy Duty Drain Base with 4" Plastic Spud

Fits Over 4" Schedule 40 DWV Pipe

MADE IN THE USA

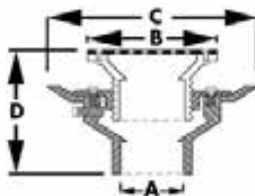

- 10" Pan
- Strainers are available in SS, PB, NB and CP
- Stainless steel strainers are .06" thick
- PB, NB and CP strainers are 3/16" thick
- Primer tapped with 1/2" plug
- Adjustable (see dimension D)

STRAINER	A	B	C	D
6" round	Over 4"	6-1/8"	11"	5-1/16" - 6-13/16"
6" round with ring	Over 4"	6-1/2"	11"	5-1/4" - 6-15/16"

PVC

PART NO.	STRAINER	CTN/MSTR
D50362	6" SS round	1/1
D50363	6" PB round	1/1
D50364	6" PB round with ring	1/1
D50365	6" NB round	1/1
D50366	6" NB round with ring	1/1
D50367	6" CP round	1/1
D50368	6" CP round with ring	1/1

ABS

PART NO.	STRAINER	CTN/MSTR
D51362	6" SS round	1/1
D51363	6" PB round	1/1
D51364	6" PB round with ring	1/1
D51365	6" NB round	1/1
D51366	6" NB round with ring	1/1
D51367	6" CP round	1/1
D51368	6" CP round with ring	1/1

4" Heavy Duty Drain Base with 4" Metal Spud

Fits Over 4" Schedule 40 DWV Pipe

MADE IN THE USA

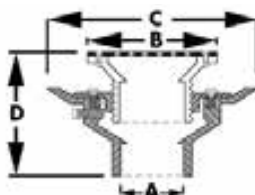

- 10" Pan
- Strainers are available in PB and NB
- Strainers are 3/16" thick
- Primer tapped with 1/2" plug
- Adjustable (see dimension D)

STRAINER	A	B	C	D
5" round	Over 4"	5"	11"	4-5/8" - 5-7/8"

PVC

PART NO.	STRAINER	CTN/MSTR
D50372	5" PB round	1/1
D50371	5" NB round	1/1

ABS

PART NO.	STRAINER	CTN/MSTR
D51372	5" PB round	1/1
D51371	5" NB round	1/1

PVC and ABS Commercial Drain Components

Pages 217-222

**SIZES: 2", 2" x 3", 3", 3-1/2",
3" x 4", 4"**



For use in
commercial applications.

Pipe Fit Base

- 2" Fits Over 2" Schedule 40 DWV Pipe
- 3" Fits Over 3" Schedule 40 DWV Pipe
- 3" x 4" Fits Over 3" or Inside 4" Schedule 40 DWV Pipe
- 4" Fits Over 4" Schedule 40 DWV Pipe



PVC

PART NO.	PIPE SIZE	SPUD	CTN/MSTR
D52120	2" with PT	2"	1/20
D52012	2"	2"	1/20
D52450	3" x 4" with PT	3"	1/10
D52400	3" x 4"	3-1/2"	1/10
D52451	3" x 4" with PT	3-1/2"	1/10
D52005	4"	3-1/2"	1/10
D52452	4" with PT	3-1/2"	1/10
D52014	4"	4"	1/10
D52453	4" with PT	4"	1/10

ABS

PART NO.	PIPE SIZE	SPUD SIZE	CTN/MSTR
D52112	2"	2"	1/20
D52016	3"	3"	1/10
D52460	3" x 4" with PT	3"	1/10
D52500	3" x 4"	3-1/2"	1/10
D52461	3" x 4" with PT	3-1/2"	1/10
D52105	4"	3-1/2"	1/10
D52462	4" with PT	3-1/2"	1/10
D52017	4"	4"	1/10
D52463	4" with PT	4"	1/10

Inside Pipe Fit Base

- 3" Fits Over 3" Schedule 40 DWV Pipe
- 4" Fits Over 4" Schedule 40 DWV Pipe



PVC

PART NO.	PIPE SIZE	SPUD	CTN/MSTR
D52023	3"	2"	1/1
D52004	4"	3"	1/1

ABS

PART NO.	PIPE SIZE	SPUD	CTN/MSTR
D52123	3"	2"	1/1
D52104	4"	3"	1/1

Hub Fit Base

Fits Inside 4" Hub Schedule 40 DWV Pipe



PVC

PART NO.	PIPE SIZE	SPUD	CTN/MSTR
D52003	4"	3-1/2"	1/1

ABS

PART NO.	PIPE SIZE	SPUD	CTN/MSTR
D52103	4"	3-1/2"	1/1

Heavy Duty Base with Clamping Ring

2" x 3" Fits Over 2" or Inside 3" Schedule 40 DWV Pipe
3" x 4" Fits Over 3" or Inside 4" Schedule 40 DWV Pipe
4" Fits Over 4" Schedule 40 DWV Pipe



- Completely adjustable; reversible clamping ring gains additional 1" height
- 8-1/2" Pan
- Extra weep holes
- Primer tapped with 1/2" plug
- Gray PVC or Black ABS

PVC

PART NO.	PIPE SIZE	SPUD	CTN/MSTR
D49800	2" x 3"	3"	1/1
D49801	2" x 3"	3-1/2"	1/1
D49802	2" x 3"	4"	1/1
D49803	3" x 4"	3"	1/1
D49804	3" x 4"	3-1/2"	1/1
D49805	3" x 4"	4"	1/1
D49806	4"	3"	1/1
D49807	4"	3-1/2"	1/1
D49808	4"	4"	1/1

ABS

PART NO.	PIPE SIZE	SPUD	CTN/MSTR
D49810	2" x 3"	3"	1/1
D49811	2" x 3"	3-1/2"	1/1
D49812	2" x 3"	4"	1/1
D49813	3" x 4"	3"	1/1
D49814	3" x 4"	3-1/2"	1/1
D49815	3" x 4"	4"	1/1
D49816	4"	3"	1/1
D49817	4"	3-1/2"	1/1
D49818	4"	4"	1/1

Slab Drain Base

2" x 3" Fits Over 2" or Inside 3" Schedule 40 DWV Pipe
3" x 4" Fits Over 3" or Inside 4" Schedule 40 DWV Pipe
4" Fits Over 4" Schedule 40 DWV Pipe



- Completely adjustable
- 8-1/2" Pan for applications where no clamping ring is required
- Spud threads directly into base
- Primer tapped with 1/2" plug
- Gray PVC or Black ABS

PVC

PART NO.	PIPE SIZE	SPUD	CTN/MSTR
D49850	2" x 3"	3"	1/1
D49851	2" x 3"	3-1/2"	1/1
D49852	2" x 3"	4"	1/1
D49853	3" x 4"	3"	1/1
D49854	3" x 4"	3-1/2"	1/1
D49855	3" x 4"	4"	1/1
D49856	4"	3"	1/1
D49857	4"	3-1/2"	1/1
D49858	4"	4"	1/1

ABS

PART NO.	PIPE SIZE	SPUD	CTN/MSTR
D49860	2" x 3"	3"	1/1
D49861	2" x 3"	3-1/2"	1/1
D49862	2" x 3"	4"	1/1
D49863	3" x 4"	3"	1/1
D49864	3" x 4"	3-1/2"	1/1
D49865	3" x 4"	4"	1/1
D49866	4"	3"	1/1
D49867	4"	3-1/2"	1/1
D49868	4"	4"	1/1

Heavy Duty Base

2" Fits Over 2" Schedule 40 DWV Pipe
3" Fits Over 3" Schedule 40 DWV Pipe
4" Fits Over 4" Schedule 40 DWV Pipe
6" Fits Over 6" Schedule 40 DWV Pipe



- 10" Pan
- Primer tapped with 1/2" plug
- Adjustable

PVC

PART NO.	PIPE SIZE	SPUD	CTN/MSTR
D52202	2"	3-1/2"	1/1
D52205	2"	4"	1/1
D52203	3"	3-1/2"	1/1
D52204	4"	3-1/2"	1/1
D52207	4"	4"	1/1
D52216	6"	3-1/2"	1/1
D52217	6"	4"	1/1

ABS

PART NO.	PIPE SIZE	SPUD	CTN/MSTR
D52302	2"	3-1/2"	1/1
D52305	2"	4"	1/1
D52303	3"	3-1/2"	1/1
D52306	3"	4"	1/1
D52304	4"	3-1/2"	1/1
D52307	4"	4"	1/1
D52316	6"	3-1/2"	1/1
D52317	6"	4"	1/1

2" Plastic Spud with Round Strainer



PVC			
PART NO.	IPS	STRAINER	CTN/MSTR
D50980	2"	4" SS	1/1
D50987	2"	4" CP	1/1
D50988	2"	4" CP with ring	1/1
D50985	2"	4" NB	1/1
D50986	2"	4" NB with ring	1/1
D50983	2"	4" PB cast	1/1
D50982	2"	4" PB stamped	1/1
D50984	2"	4" PB with ring	1/1

ABS			
PART NO.	IPS	STRAINER	CTN/MSTR
D57980	2"	4" SS	1/1
D57987	2"	4" CP	1/1
D57988	2"	4" CP with ring	1/1
D57985	2"	4" NB	1/1
D57986	2"	4" NB with ring	1/1
D57983	2"	4" PB cast	1/1
D57982	2"	4" PB stamped	1/1
D57984	2"	4" PB with ring	1/1

2" Metal Spud with Round Strainer



PART NO.	IPS	STRAINER	CTN/MSTR
D60980	2"	4" SS	1/50
D60981	2"	4" CP	1/50
D60982	2"	4" PB	1/50
D60970	2"	6" CP	1/30
D60975	2"	6" PB	1/30

2" Plastic Spud with Square Strainer



PVC			
PART NO.	IPS	STRAINER	CTN/MSTR
D50989	2"	4" CP	1/1
D50990	2"	4" PB	1/1

ABS			
PART NO.	IPS	STRAINER	CTN/MSTR
D57989	2"	4" CP	1/1
D57990	2"	4" PB	1/1

3" Plastic Spud with Round Strainer



PVC			
PART NO.	IPS	STRAINER	CTN/MSTR
D56105	3"	6" SS	1/1
D56205	3"	6" CP	1/1
D56210	3"	6" CP with ring	1/1
D56405	3"	6" NB	1/1
D56404	3"	6" NB with ring	1/1
D56305	3"	6" PB	1/1
D56304	3"	6" PB with ring	1/1

ABS			
PART NO.	IPS	STRAINER	CTN/MSTR
D57105	3"	6" SS	1/1
D57205	3"	6" CP	1/1
D57210	3"	6" CP with ring	1/1
D57405	3"	6" NB	1/1
D57404	3"	6" NB with ring	1/1
D57305	3"	6" PB	1/1
D57304	3"	6" PB with ring	1/1

3" Metal Spud with Round Strainer



PART NO.	IPS	STRAINER	CTN/MSTR
D60955	3"	5" NB	1/30
D60956	3"	5" PB	1/30
D60945	3"	8" NB	1/12

3" Plastic Spud with 7" Square Top and Round Strainer



PVC			
PART NO.	IPS	STRAINER	CTN/MSTR
D56501	3"	5" NB	1/1

ABS			
PART NO.	IPS	STRAINER	CTN/MSTR
D57501	3"	5" NB	1/1

3-1/2" Plastic Spud with Round Strainer



PVC			
PART NO.	IPS	STRAINER	CTN/MSTR
D56211	3-1/2"	5" SS	1/1
D56216	3-1/2"	5" CP	1/1
D56217	3-1/2"	5" CP with ring	1/1
D56214	3-1/2"	5" NB	1/1
D56215	3-1/2"	5" NB with ring	1/1
D56212	3-1/2"	5" PB	1/1
D56213	3-1/2"	5" PB with ring	1/1
D56106	3-1/2"	6" SS	1/1
D56206	3-1/2"	6" CP	1/1
D56209	3-1/2"	6" CP with ring	1/1
D56406	3-1/2"	6" NB	1/1
D56407	3-1/2"	6" NB with ring	1/1
D56306	3-1/2"	6" PB	1/1
D56307	3-1/2"	6" PB with ring	1/1

ABS			
PART NO.	IPS	STRAINER	CTN/MSTR
D57211	3-1/2"	5" SS	1/1
D57216	3-1/2"	5" CP	1/1
D57217	3-1/2"	5" CP with ring	1/1
D57214	3-1/2"	5" NB	1/1
D57215	3-1/2"	5" NB with ring	1/1
D57212	3-1/2"	5" PB	1/1
D57213	3-1/2"	5" PB with ring	1/1
D57106	3-1/2"	6" SS	1/1
D57206	3-1/2"	6" CP	1/1
D57209	3-1/2"	6" CP with ring	1/1
D57406	3-1/2"	6" NB	1/1
D57407	3-1/2"	6" NB with ring	1/1
D57306	3-1/2"	6" PB	1/1
D57307	3-1/2"	6" PB with ring	1/1

3-1/2" Metal Spud with Round Strainer



PART NO.	IPS	STRAINER	CTN/MSTR
D60986	3-1/2"	4" NB	1/40
D60987	3-1/2"	4" PB	1/40
D60990	3-1/2"	5" CP	1/40
D60996	3-1/2"	5" NB	1/40
D60991	3-1/2"	5" PB	1/40
D60992	3-1/2"	6" CP	1/20
D60997	3-1/2"	6" NB	1/20
D60993	3-1/2"	6" PB	1/20
D60998	3-1/2"	8" NB	1/12
D60995	3-1/2"	8" PB	1/10
D60999	3-1/2"	9" NB	1/12
D60989	3-1/2"	9" PB	1/12

3-1/2" Metal Spud with Square Strainer



PART NO.	IPS	STRAINER	CTN/MSTR
D60954	3-1/2"	5" CP	1/20
D60962	3-1/2"	5" NB	1/20
D60960	3-1/2"	5" PB	1/20
D60963	3-1/2"	6" NB	1/12
D60961	3-1/2"	6" PB	1/12

3-1/2" Plastic Spud with 7" Square Top and Round Strainer



PVC			
PART NO.	IPS	STRAINER	CTN/MSTR
D56503	3-1/2"	5" NB	1/1

4" Plastic Spud with Round Strainer



PVC			
PART NO.	IPS	STRAINER	CTN/MSTR
D56107	4"	6" SS	1/1
D56207	4"	6" CP	1/1
D56208	4"	6" CP with ring	1/1
D56408	4"	6" NB	1/1
D56409	4"	6" NB with ring	1/1
D56308	4"	6" PB	1/1
D56309	4"	6" PB with ring	1/1

ABS			
PART NO.	IPS	STRAINER	CTN/MSTR
D57107	4"	6" SS	1/1
D57207	4"	6" CP	1/1
D57208	4"	6" CP with ring	1/1
D57408	4"	6" NB	1/1
D57409	4"	6" NB with ring	1/1
D57308	4"	6" PB	1/1
D57309	4"	6" PB with ring	1/1

4" Metal Spud with Round Strainer



PART NO.	IPS	STRAINER	CTN/MSTR
D60958	4"	5" NB	1/30
D60959	4"	5" PB	1/30
D60940	4"	9" NB	1/8

4" Plastic Spud with 7" Square Top and Round Strainer



PVC			
PART NO.	IPS	STRAINER	CTN/MSTR
D56505	4"	5" NB	1/1
ABS			
PART NO.	IPS	STRAINER	CTN/MSTR
D57505	4"	5" NB	1/1

Replacement Strainer for Metal Spud

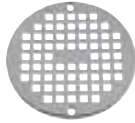

- Round
- Includes screws

PART NO.	FINISH	SIZE	CTN/MSTR
D60780	Stainless Steel	4" stamped	100/400
D60781	Chrome Plated	4"	1/200
D60782	Polished Brass	4"	1/200
D60967	Polished Brass	4"	1/100
D60966	Nickel Bronze	4"	1/50
D60790	Chrome Plated	5"	1/150
D60791	Polished Brass	5"	1/50
D60968	Nickel Bronze	5"	1/50
D60792	Chrome Plated	6"	1/50
D60793	Polished Brass	6"	1/50
D60969	Nickel Bronze	6"	1/50
D60795	Polished Brass	8"	1/30

Strainers/Coveralls



- 4" Fits 4-1/4" diameter drain and cleanout spuds, D50 (2" x 3") series shower drains and 2" x 3" General Purpose Drains
- 5" Fits 5" diameter drain and cleanout spuds and 3" x 4" General Purpose Drains
- 6" Fits 6-1/8" diameter drain and cleanout spuds and 4" General Purpose Drains
- Includes screws

Round			
PART NO.	SIZE	DESCRIPTION	CTN/MSTR
C60809	4"	SS coverall	100/400
D54008	4"	SS fits inside plastic ring	100/400
C60806	4"	CP cast coverall	1/100
C60808	4"	NB cast coverall	1/100
C60807	4"	PB cast coverall	1/100
C60810	4"	PB PVD finish coverall	1/400
C60814	4"	SN coverall	100/400
D54010	4"	PB fits inside plastic ring	1/100
C60811	5"	SS coverall	50/200
D54108	5"	SS fits inside plastic ring	60/240
C60803	5"	CP cast coverall	1/50
C60805	5"	NB cast coverall	1/50
C60804	5"	PB cast coverall	1/50
D59100	6"	SS coverall	1/125
C60800	6"	CP cast coverall	1/50
C60802	6"	NB cast coverall	1/50
C60801	6"	PB cast coverall	1/50

Square			
PART NO.	SIZE	DESCRIPTION	CTN/MSTR
C60888	4"	SS stamped square snap-in coverall	1/100
C60812	4"	CP cast square coverall	1/100
C60813	4"	PB cast square coverall	1/100
C60810	4"	PB PVD finish coverall	1/400

Rings



- 4" Fits 4-1/4" diameter drain and cleanout spuds, D50 (2" x 3") series shower drains and 2" x 3" General Purpose Drains
- 5" Fits 5" diameter drain and cleanout spuds and 3" x 4" General Purpose Drains
- 6" Fits 6-1/8" diameter drain and cleanout spuds and 4" General Purpose Drains

PART NO.	SIZE	DESCRIPTION	CTN/MSTR
C60818	4"	CP ring	1/200
C60825	4"	NB ring	1/200
C60824	4"	PB ring	1/200
C60819	5"	CP ring	1/100
C60823	5"	NB ring	1/100
C60822	5"	PB ring	1/100
C60817	6"	CP ring	1/80
C60821	6"	NB ring	1/80
C60820	6"	PB ring	1/80

Spud Extension



- 2-1/2" - 4" extension for a 3-1/2" drain / cleanout spud
- Use on cast iron or PVC drain bodies when additional height is needed to offset inconsistent concrete pours

PART NO.	SIZE	DESCRIPTION	CTN/MSTR
D60979	3-1/2"	Spud extension	1/12

Funnels



- Supplied with screws
- Vandal-proof installation
- Fits virtually any floor/shower drain
- Funnel tapped for 10-24 screws which are supplied with washers

PART NO.	SIZE	DESCRIPTION	CTN/MSTR
F65400	4"	Funnel	1/1
F65600	6"	Funnel	1/1

E Got To Have It!
The Green Drain Waterless Trap Seal

- Prevents the spread of different dangerous bacteria that can cause potential health hazards
- Eliminates the need to frequently pour primer and fresh water down the drain
- Saves a significant amount of time, water, costs and energy

- Requires no caulk or expensive installation tool
- Easy to install and easy to remove - no pliers needed
- Durable - will not break during installation or removal
- Seals tight - no leaking!



MODEL NUMBER	"A" (PIPE SIZE)	"B" (HEIGHT)
P24001	2" (51)	2" (51)
P24002	3" (76)	2" (51)
P24003	3 1/2" (89)	2" (51)
P24004	4" (102)	2" (51)

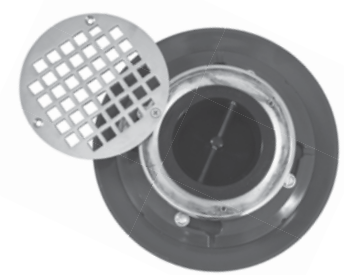

PART NO.	DESCRIPTION	CTN/MSTR
P24001	2" waterless trap seal	1/96
P24002	3" waterless trap seal	1/96
P24003	3-1/2" waterless trap seal	1/96
P24004	4" waterless trap seal	1/96

Items marked with the Jones Stephens logo are "You Need It... We Got It" Items.

PVC and ABS General Purpose/Utility Drains

Pages 223-227

SIZES: 2", 2" x 3", 3", 3" x 4", 4"



For use in residential and commercial applications.

2" x 3" General Purpose Drain

Fits Over 2" or Inside 3" Schedule 40 DWV Pipe

MADE IN THE
USA
NSF

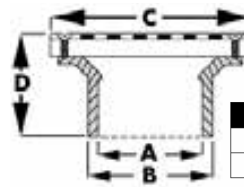

- Coverall top
- Brass inserts

	A	B	C	D
Less rings: Over 2" pipe		Inside 3" pipe	4-1/4"	1-1/2"
With rings: Over 2" pipe		Inside 3" pipe	4-1/2"	2-1/4"

PVC

PART NO.	STRAINER	CTN/MSTR
D54001	4" SS round	1/20
D54013	4" NB round	1/20
D54014	4" NB round with ring	1/20
D54002	4" CP round	1/20
D54022	4" CP round with ring	1/20
D54015	4" PB round stamped (PVD)	1/20
D54011	4" PB round cast	1/20
D54012	4" PB round cast with ring	1/20

ABS

PART NO.	STRAINER	CTN/MSTR
D54301	4" SS round	1/20
D54313	4" NB round	1/20
D54314	4" NB round with ring	1/20
D54302	4" CP round	1/20
D54319	4" CP round with ring	1/20
D54315	4" PB round stamped (PVD)	1/20
D54311	4" PB round cast	1/20
D54312	4" PB round cast with ring	1/20

2" x 3" General Purpose Drain with Long Body

Fits Over 2" or Inside 3" Schedule 40 DWV Pipe

MADE IN THE
USA

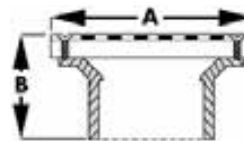

- Coverall top
- Brass inserts

PART NO.	A	B
D54001L	4-1/4"	2"
D54002L	4-1/4"	2-1/8"
D54013L	4-1/4"	2-1/8"
D54014L	4-1/2"	2-1/4"

PVC

PART NO.	DESCRIPTION	CTN/MSTR
D54001L	4" SS round	1/20
D54002L	4" CP brass round	1/20
D54013L	4" NB round	1/20
D54014L	4" NB round with ring	1/20

General Purpose Drain with Cast Iron Strainer

2" x 3" Fits Over 2" or Inside 3" Schedule 40 DWV Pipe
3" x 4" Fits Over 3" or Inside 4" Schedule 40 DWV Pipe
4" Fits Over 4" Schedule 40 DWV Pipe

MADE IN THE
USA

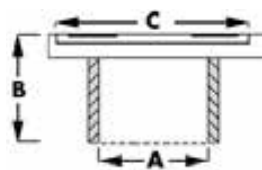

• Cast iron strainer for heavy trucking traffic areas

SIZE	A	B	C
2" x 3"	2-3/8" ID 3" OD	2-1/8"	4-3/4" ID 5-1/8" OD
3" x 4"	3-5/8" ID 4" OD	3-1/8"	4-5/8" ID 5-1/8" OD
4"	4-5/8" ID 5-1/16" OD	3-3/8"	5-3/8" ID 5-3/4" OD

PVC

PART NO.	SIZE	STRAINER	CTN/MSTR
D54016	2" x 3"	CI with ring	1/1
D54126	3" x 4"	CI with ring	1/1
D54136	4"	CI with ring	1/1

ABS

PART NO.	SIZE	STRAINER	CTN/MSTR
D54316	2" x 3"	CI with ring	1/1
D54326	3" x 4"	CI with ring	1/1
D54336	4"	CI with ring	1/1

3" x 4" General Purpose Drain

Fits Over 3" or Inside 4" DWV Pipe

MADE IN THE
USA

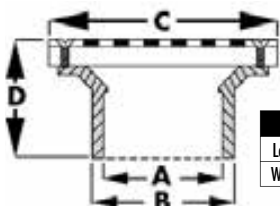

• Coverall top
• Brass inserts

A	B	C	D
Less rings: 3" socket	Inside 4" pipe	5-3/16"	2-3/8"
With rings: 3" socket	Inside 4" pipe	5-1/2"	2-11/16"

PVC

PART NO.	STRAINER	CTN/MSTR
D54100	5" SS round	1/10
D54113	5" NB round	1/10
D54114	5" NB round with ring	1/10
D54101	5" CP round	1/10
D54107	5" CP round with ring	1/10
D54111	5" PB round	1/10
D54112	5" PB round with ring	1/10

ABS

PART NO.	STRAINER	CTN/MSTR
D54400	5" SS round	1/10
D54323	5" NB round	1/10
D54324	5" NB round with ring	1/10
D54401	5" CP round	1/10
D54307	5" CP round with ring	1/10
D54321	5" PB round	1/10
D54322	5" PB round with ring	1/10

4" General Purpose Drain

Fits Over 4" Schedule 40 DWV Pipe

MADE IN THE
USA

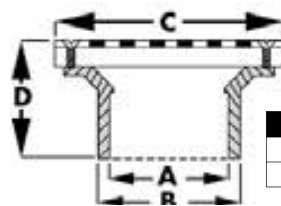

• Coverall top
• Brass Inserts

A	B	C	D
Less rings: Over 4" pipe	5"	6-3/16"	2-5/8"
With rings: Over 4" pipe	5"	6-7/16"	2-3/4"

PVC

PART NO.	STRAINER	CTN/MSTR
D54104	6" SS round	1/10
D54130	6" NB round	1/10
D54132	6" NB round with ring	1/10
D54102	6" CP round	1/10
D54137	6" CP round with ring	1/10
D54105	6" PB round	1/10
D54131	6" PB round with ring	1/10
D54134	7" NB square	1/5

ABS

PART NO.	STRAINER	CTN/MSTR
D54304	6" SS round	1/10
D54330	6" NB round	1/10
D54332	6" NB round with ring	1/10
D54305	6" CP round	1/10
D54337	6" CP round with ring	1/10
D54306	6" PB round	1/10
D54331	6" PB round with ring	1/10
D54334	7" NB square	1/5

8-1/2" Pan Heavy Duty Traffic Floor Drain

MADE IN THE
USA



• Floor sink, area drain, garbage drain, yard drain
• Full plastic 7-1/4" grate; 8-1/2" pan
• Sediment bucket option

PVC

PART NO.	DESCRIPTION	CTN/MSTR
D49820	2" x 3" drain	1/1
D49821	3" x 4" drain	1/1
D49822	4" drain	1/1
D49826	2" x 3" drain (with sediment bucket)	1/1
D49827	3" x 4" drain (with sediment bucket)	1/1
D49828	4" drain (with sediment bucket)	1/1

ABS

PART NO.	DESCRIPTION	CTN/MSTR
D49823	2" x 3" drain	1/1
D49824	3" x 4" drain	1/1
D49825	4" drain	1/1
D49829	2" x 3" drain (with sediment bucket)	1/1
D49830	3" x 4" drain (with sediment bucket)	1/1
D49831	4" drain (with sediment bucket)	1/1

Sediment Bucket Only

PART NO.	DESCRIPTION	CTN/MSTR
D49924	Sediment bucket	1/1

Heavy Duty Traffic Floor Drain

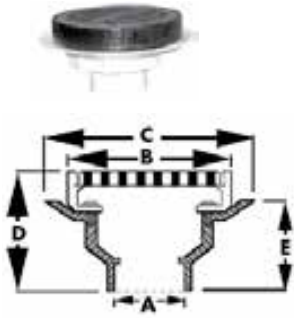

- Floor sink, area drain, garbage drain, yard drain
- 8-1/2" diameter grate
- Brass inserts
- Available with cast iron or plastic grate and ring
- Includes 1/2" primer tap



	A	B	C	D	E
Over 2" pipe	9"	11"	4-11/16"	3-5/16"	
Over 3" pipe	9"	11"	4-11/16"	3-5/16"	
Over 4" pipe	9"	11"	5-1/16"	3-5/16"	

PVC - Full Cast Iron Grate and Ring

PART NO.	DESCRIPTION	CTN/MSTR
D50092	2" drain	1/1
D50093	3" drain	1/1
D50094	4" drain	1/1
D50089	2" drain with CI sediment bucket	1/1
D50090	3" drain with CI sediment bucket	1/1
D50091	4" drain with CI sediment bucket	1/1

ABS - Full Cast Iron Grate and Ring

PART NO.	DESCRIPTION	CTN/MSTR
D50392	2" drain	1/1
D50393	3" drain	1/1
D50394	4" drain	1/1
D50389	2" drain with CI sediment bucket	1/1
D50390	3" drain with CI sediment bucket	1/1
D50391	4" drain with CI sediment bucket	1/1

PVC - Full Plastic Grate and Ring

PART NO.	DESCRIPTION	CTN/MSTR
D50177	2" drain	1/1
D50179	3" drain	1/1
D50181	4" drain	1/1
D50178	2" drain with plastic debris bucket	1/1
D50180	3" drain with plastic debris bucket	1/1
D50182	4" drain with plastic debris bucket	1/1
D50682	6" drain with plastic debris bucket	1/1

ABS - Full Plastic Grate and Ring

PART NO.	DESCRIPTION	CTN/MSTR
D50377	2" drain	1/1
D50379	3" drain	1/1
D50381	4" drain	1/1
D50378	2" drain with plastic debris bucket	1/1
D50380	3" drain with plastic debris bucket	1/1
D50382	4" drain with plastic debris bucket	1/1
D50683	6" drain with plastic debris bucket	1/1

PVC - Three-Quarter Plastic Grate and Ring

PART NO.	DESCRIPTION	CTN/MSTR
D50183	2" drain	1/1
D50184	3" drain	1/1
D50185	4" drain	1/1

ABS - Three-Quarter Plastic Grate and Ring

PART NO.	DESCRIPTION	CTN/MSTR
D50383	2" drain	1/1
D50384	3" drain	1/1
D50385	4" drain	1/1

PVC - Half Plastic Grate and Ring

PART NO.	DESCRIPTION	CTN/MSTR
D50186	2" drain	1/1
D50187	3" drain	1/1
D50188	4" drain	1/1

ABS - Half Plastic Grate and Ring

PART NO.	DESCRIPTION	CTN/MSTR
D50386	2" drain	1/1
D50387	3" drain	1/1
D50388	4" drain	1/1

PVC - Replacement Parts

PART NO.	DESCRIPTION	CTN/MSTR
D50904	Full plastic grate	1/1
D50906	Three-quarter plastic grate	1/1
D50908	Half plastic grate	1/1
D50910	Plastic debris bucket	1/1
D50095	CI sediment bucket	1/1

ABS - Replacement Parts

PART NO.	DESCRIPTION	CTN/MSTR
D50905	Full plastic grate	1/1
D50907	Three-quarter plastic grate	1/1
D50909	Half plastic grate	1/1
D50911	Plastic debris bucket	1/1

All Plastic Snap-In Drain

Fits Into Schedule 40 DWV Pipe

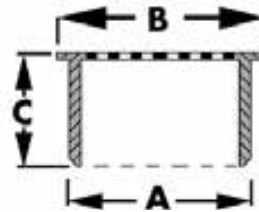

	A	B	C
Inside 2"	2-3/8"	1"	
Inside 3"	3-1/2"	1-3/4"	
Inside 4"	4-1/2"	2"	

PVC

PART NO.	DESCRIPTION	CTN/MSTR
D42002	2" snap-in drain	1/20
D42003	3" snap-in drain	1/20
D42004	4" snap-in drain	1/20

ABS

PART NO.	DESCRIPTION	CTN/MSTR
D42022	2" snap-in drain	1/20
D42023	3" snap-in drain	1/20
D42024	4" snap-in drain	1/20

Snap-In Drain with Stainless Steel Strainer

Fits Into Schedule 40 DWV Pipe

MADE IN THE
USA

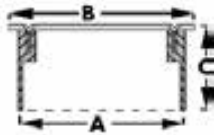

A	B	C
Inside 3" pipe	3-1/2"	2"
Inside 4" pipe	4-1/2"	2"

PVC

PART NO.	DESCRIPTION	CTN/MSTR
D54003	3" snap-in drain	1/20
D54004	4" snap-in drain	1/20

ABS

PART NO.	DESCRIPTION	CTN/MSTR
D54005	3" snap-in drain	1/20
D54006	4" snap-in drain	1/20

Snap-In Strainer

Fits Inside Pipe



• Stainless steel

PART NO.	DESCRIPTION	CTN/MSTR
D59001	3-1/8" strainer fits inside 2" pipe	10/200
D59002	4-1/8" strainer fits inside 3" pipe	10/200
D59003	5-1/8" strainer fits inside 4" pipe	10/100

Socket Ring

MADE IN THE
USA

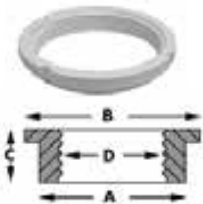

• Solvent welds into Schedule 40 hub to make threaded connection

A	B	C	D
2"	2-3/4"	1/2"	2" FIP
3"	4-1/16"	5/8"	3" FIP
4"	5-1/16"	5/8"	4" FIP

PVC

PART NO.	DESCRIPTION	CTN/MSTR
P48002	2" socket ring	1/20
P48003	3" socket ring	1/20
P48004	4" socket ring	1/20

ABS

PART NO.	DESCRIPTION	CTN/MSTR
P48102	2" socket ring	1/20
P48103	3" socket ring	1/20
P48104	4" socket ring	1/20

Utility Drain

MADE IN THE
USA

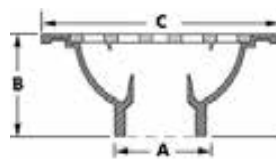

• Snap-in lid
• Use 2" coupling to connect 6" x 6" to 2" pipe

A	B	C	D
1-1/2" x 2"	2-3/8"	6"	4-9/16"
3" x 4"	3-7/16"	9"	7-11/16"
4"	4-9/16"	9"	7-11/16"
4" w/out stop	4-9/16"	9"	7-11/16"

PVC

PART NO.	DESCRIPTION	CTN/MSTR
D40020	6" x 6" with pipe stop; 1-1/2" hub; 2" spigot	1/20
D40021	9" x 9" with pipe stop; 3" hub; 4" spigot	1/10
D40023	9" x 9" with pipe stop; 4" hub	1/10
D42019	9" x 9" with 4" hub	1/10

ABS

PART NO.	DESCRIPTION	CTN/MSTR
D42029	9" x 9" with 4" hub	1/10

Bell Trap

MADE IN THE
USA

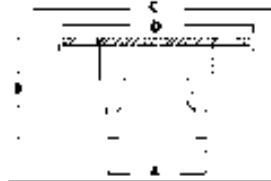

• Snap-in lid
• Molded bell in lid
• Use 2" coupling to convert 6" x 6" x 1-1/2" to 2" outlet

A	B	C	D
1-1/2" x 2"	2-3/8"	6"	4-9/16"
3" x 4"	4"	9"	7-3/4"
4"	4-1/2"	9"	7-3/4"

PVC

PART NO.	DESCRIPTION	CTN/MSTR
D42006	6" x 6" with 1-1/2" x 2" outlet	1/20
D42009	9" x 9" with 3" x 4" outlet	1/10
D42010	9" x 9" with 4" hub fit outlet	1/10

ABS

PART NO.	DESCRIPTION	CTN/MSTR
D42011	6" x 6" with 1-1/2" x 2" outlet	1/20
D42012	9" x 9" with 3" x 4" outlet	1/10
D42013	9" x 9" with 4" hub fit outlet	1/10

PVC Accessories

PART NO.	DESCRIPTION	CTN/MSTR
D42007	Lid for the D42006	1/1
D42008	Lid for the D42009 and D42010	1/1

ABS Accessories

PART NO.	DESCRIPTION	CTN/MSTR
D42014	Lid for the D42011	1/1
D42015	Lid for the D42012 and D42013	1/1

Heavy Duty PVC Bell Trap with Hinged Lid

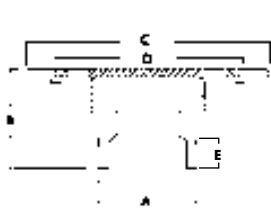

MADE IN THE
USA

- Molded bell in lid
- Use 2" coupling to convert 6" x 6" x 1-1/2" to 2" outlet

A	B	C	D	E
1-1/2" x 2"	2-1/2"	6"	4-1/2"	3/4"
3" x 4"	4-3/8"	9"	7-3/4"	3/4"
4"	4-1/2"	9"	7-3/4"	3/4"

PVC

PART NO.	DESCRIPTION	CTN/MSTR
D42006H	6" x 6" with 1-1/2" x 2" outlet	1/20
D42009H	9" x 9" with 3" x 4" outlet	1/10
D42010H	9" x 9" with 4" outlet	1/10

Accessories

PART NO.	DESCRIPTION	CTN/MSTR
D42007H	Lid for the D42006H	1/1
D42008H	Lid for the D42009H and D42010H	1/1

Floor Drain with Trap

2" Solvent Weld Outlet



- Full 2" flow
- One-piece construction (not welded together)
- For concrete floors on or below grade
- Deep 3-1/4" sump bowl
- Dual primer bosses
- Strainer is 1/2" thick
- 2" concealed cleanout
- Stands upright for easy rough-in, also has rough-in tabs
- Threaded for backwater device

MADE IN THE
USA

PIPE SIZE	B	C	D
2" IPS	7-5/8"	10-7/8"	11-3/4"

PVC

PART NO.	DESCRIPTION	CTN/MSTR
D50200	2" with full plastic grate	1/12
D50208	2" with 7-1/2" NB strainer	1/12

ABS

PART NO.	DESCRIPTION	CTN/MSTR
D50600	2" with full plastic grate	1/12

PVC - Accessories

PART NO.	DESCRIPTION	CTN/MSTR
D50202	Full grate strainer	1/1
D50204	Half grate strainer	1/1

ABS - Accessories

PART NO.	DESCRIPTION	CTN/MSTR
D50205	Full grate strainer	1/1
D50206	Three-quarter grate strainer	1/1
D50207	Half grate strainer	1/1

Other Accessories

PART NO.	DESCRIPTION	CTN/MSTR
D50213	NB strainer	1/1
B06001	Plastic backwater device	1/1
B70499	Replacement ball	1/1

4-Way Area Drain

Fits 2" or 3" Pipe

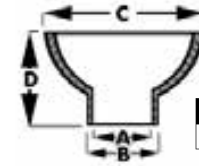

MADE IN THE
USA

- Use with or without a p-trap

A	B	C	D
Over 2" pipe	Inside 3" pipe	7-1/4"	3-3/4"

PVC

PART NO.	DESCRIPTION	CTN/MSTR
D50201	2" x 3" area drain	1/15
D50220	2" x 3" area drain without stop	1/15
B06010	Replacement strainer for D50201	1/1

ABS

PART NO.	DESCRIPTION	CTN/MSTR
D50601	2" x 3" area drain	1/15
D50221	2" x 3" area drain without stop	1/15
B06100	Replacement strainer for D50601	1/1

Area Drain

2" x 3" Fits Over 2" or Inside 3" Schedule 40 DWV Pipe
3" x 4" Fits Over 3" or Inside 4" Schedule 40 DWV Pipe

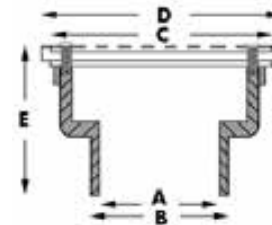

MADE IN THE
USA

- 5" strainer can be installed as snap-in or screwed in

SIZE	A	B	C	D	E
2" x 3"	2"	3"	5"	6-3/16"	2-3/8"
3" x 4"	3"	4"	5"	6-3/16"	2-3/8"

PVC

PART NO.	DESCRIPTION	CTN/MSTR
D40600	2" x 3" area drain	1/12
D40601	3" x 4" area drain	1/12
D40602	PVC replacement strainer	1/1

ABS

PART NO.	DESCRIPTION	CTN/MSTR
D40700	2" x 3" area drain	1/12
D40701	3" x 4" area drain	1/12

PVC Inside Pipe Fit Drains and Cleanouts

Page 228

SIZES: 3", 4"



For use in applications where adjustments after the concrete pour are required.

Items marked with the Jones Stephens logo are "You Need It...We Got It" Items.

Inside Pipe Fit Drain

MADE IN THE
USA



• Strainer is the same diameter as the pipe to provide full coverage every time!

PART NO.	BASE	STRAINER	CTN/MSTR
D60131	3" PVC	3-1/2" CP round	1/1
D60130	3" PVC	3-1/2" NB round	1/1
D60141	4" PVC	4-1/2" CP round	1/1
D60140	4" PVC	4-1/2" NB round	1/1

Inside Pipe Fit Cleanout

MADE IN THE
USA



• Cover is the same diameter as the pipe to provide full coverage every time!

PART NO.	BASE	COVER	CTN/MSTR
C60172	3" PVC	3-1/2" NB round	1/1
C60170 	4" PVC	4-1/2" NB round	1/1
C60171	4" PVC	4-1/2" Cast Iron round	1/1

HOW IT WORKS!

Concrete Floor Application

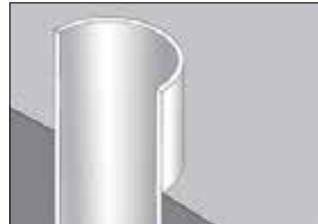

The concrete should be poured so that the pipe stack is above the finished surface.



After concrete is complete, use an EZ Stroke pipe saw to cut flush with concrete. Then, use a socket saver or inside pipe cutter to trim pipe 3/8" below concrete surface.



The inside pipe fit drain/cleanout can easily be glued into the pipe creating a level surface once the strainer is installed. No chisel or tape needed!

Tile Floor Application



The concrete should be poured so that the pipe stack is above the finished surface.



After concrete is complete, use an EZ Stroke pipe saw to cut flush with concrete. The inside pipe fit drain/cleanout can easily be glued into the pipe.



Lay tile to the edge of the cover or strainer. No chisel or tape needed!

PVC and ABS Residential and Light Commercial Cleanouts

Pages 229-231

**SIZES: 1-1/2", 2", 2-1/2", 2"x 3",
3", 3-1/2", 3"x 4", 4"**



For use in residential and light commercial applications.

Internal Pipe Cleanout

Solvent Welds Into Schedule 40 DWV Pipe

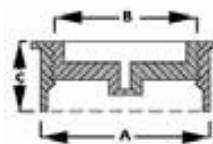

MADE IN THE
USA

- Allows pipe to be cut flush with floor or wall
- Countersunk plug included

	A	B	C
Inside 2"		1-1/2"	1"
Inside 3"		2-1/2"	1-1/8"
Inside 4"		3-1/2"	1-1/4"

PVC

PART NO.	PIPE SIZE	PLUG SIZE	OD	CTN/MSTR
C60106	2"	1-1/2" IPS	1-7/8"	1/100
C60007	3"	2-1/2" IPS	2-13/16"	1/10
C60008	4"	3-1/2" IPS	4"	1/50
C60116	2"	1-1/2" with insert	—	1/10
C60117	3"	2-1/2" with insert	—	1/10
C60118	4"	3-1/2" with insert	—	1/10

ABS

PART NO.	PIPE SIZE	PLUG SIZE	OD	CTN/MSTR
C60107	2"	1-1/2" IPS	1-7/8"	1/100
C60011	3"	2-1/2" IPS	2-13/16"	1/10
C60012	4"	3-1/2" IPS	4"	1/10

Heavy Duty Internal Pipe Cleanout

Solvent Welds Into Schedule 40 DWV Pipe

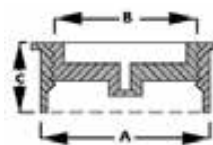

MADE IN THE
USA

- Allows pipe to be cut flush with floor or wall
- Countersunk plug included

	A	B	C
Inside 3"		2-1/4"	1-7/8"
Inside 4"		3-1/2"	2"

PVC

PART NO.	SIZE	PLUG SIZE	CTN/MSTR
C60207	3"	2" IPS	1/10
C60108	4"	3" IPS	1/10

ABS

PART NO.	SIZE	PLUG SIZE	CTN/MSTR
C60211	3"	2" IPS	1/10
C60112	4"	3" IPS	1/10

Hub/Fitting Cleanout

Fits Inside 4" Schedule 40 DWV Fittings

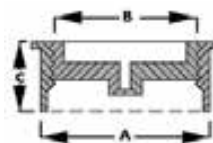

MADE IN THE
USA

- 3-1/2" IPS countersunk plug
- Solvent welds into 4" fitting hubs

	A	B	C
	4-1/2"	3-7/8"	2-3/16"

PVC

PART NO.	DESCRIPTION	CTN/MSTR
C60009	4" hub/fitting cleanout	1/10

ABS

PART NO.	DESCRIPTION	CTN/MSTR
C60010	4" hub/fitting cleanout	1/10

Fit-Flush Cleanout

2" x 3" Fits Over 2" or Inside 3" Schedule 40 DWV Pipe
3" x 4" Fits Over 3" or Inside 4" Schedule 40 DWV Pipe

MADE IN THE
USA

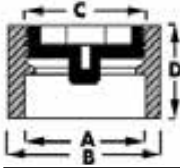

- Built-in stop
- Fits flush everytime

A	B	C	D
Over 2"	Inside 3"	2"	2"
Over 3"	Inside 4"	3"	2-1/2"

PVC

PART NO.	SIZE	PLUG SIZE	OD	CTN/MSTR
C61023	2" x 3"	2" IPS	2-3/8"	1/1
C61034	3" x 4"	3" IPS	3-1/2"	1/1
C61223	2" x 3"	2" IPS brass	2-3/8"	1/1
C61234	3" x 4"	3" IPS brass	3-1/2"	1/1
C61432	2" x 3"	2" with insert	2-3/8"	1/1
C61434	3" x 4"	3" with insert	3-1/2"	1/1

ABS

PART NO.	SIZE	PLUG SIZE	OD	CTN/MSTR
C61123	2" x 3"	2" IPS	2-3/8"	1/1
C61134	3" x 4"	3" IPS	3-1/2"	1/1

Countersunk Cleanout Plug with Insert



- White plastic
- With threaded brass insert for cleanout covers

MADE IN THE
USA

PART NO.	DESCRIPTION	CTN/MSTR
P49915	1-1/2" countersunk cleanout plug	1/100
P49920	2" countersunk cleanout plug	1/100
P49925	2-1/2" countersunk cleanout plug	1/25
P49930	3" countersunk cleanout plug	1/25
P49935	3-1/2" countersunk cleanout plug	1/25
P49940	4" countersunk cleanout plug	1/25

Raised Head Cleanout Plug



- White plastic

MADE IN THE
USA

PART NO.	DESCRIPTION	CTN/MSTR
P49250	2-1/2" raised head cleanout plug	1/25
P49350	3-1/2" raised head cleanout plug	1/25

Countersunk Cleanout Plug



- White plastic

MADE IN THE
USA

PART NO.	DESCRIPTION	CTN/MSTR
P49015	1-1/2" countersunk cleanout plug	1/100
P49002	2" countersunk cleanout plug	1/100
P49025	2-1/2" countersunk cleanout plug	1/25
P49003	3" countersunk cleanout plug	1/25
P49035	3-1/2" countersunk cleanout plug	1/25
P49004	4" countersunk cleanout plug	1/25

Drainable Cleanout Test Plug

MADE IN THE
USA

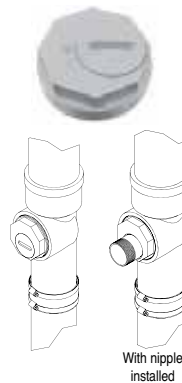

- PVC
- 4" IPS thread size; 2" IPS thread size for drain plug and spout
- Threads into any plastic or cast iron cleanout, or test tee that accepts 4" threads
- Add nipple to create drainage spout
- Easy installation; can be installed horizontal or vertical
- Drain the line without coming in contact with waste!
- Reduce distance between technician and blockage - shorter sewer rods!
- Search for another access is not needed!

PART NO.	DESCRIPTION	CTN/MSTR
P48400	4" drainable cleanout test plug	1/72

4" PVC Hub Fit Cleanout with 3-1/2" Countersunk Brass Plug

MADE IN THE
USA



- Fits flush
- Fits inside 4" hub or Schedule 40 DWV fitting

PART NO.	DESCRIPTION	CTN/MSTR
C61009	4" PVC hub fit cleanout	1/10

General Purpose Cleanout

3" x 4" Fits Over 3" or Inside 4" Schedule 40 DWV Pipe
4" Fits Over 4" Schedule 40 DWV Pipe

MADE IN THE
USA

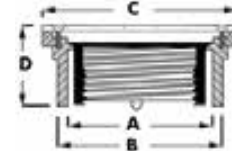

- Supplied with a combination test plug installed

A	B	C	D
Over 3"	Inside 4"	5-3/16"	2-1/2"
Over 4"	—	6-1/8"	2-1/2"

PVC

PART NO.	DESCRIPTION	CTN/MSTR
C60162	3" x 4" with NB cover	1/5
C60165	3" x 4" with NB cover & ring	1/5
C60160	3" x 4" with PB cover	1/5
C60164	3" x 4" with PB cover & ring	1/5
C60142	4" with NB cover	1/5
C60146	4" with NB cover & ring	1/5
C60140	4" with PB cover	1/5
C60144	4" with PB cover & ring	1/5

ABS

PART NO.	DESCRIPTION	CTN/MSTR
C60163	3" x 4" with NB cover	1/5
C60167	3" x 4" with NB cover & ring	1/5
C60161	3" x 4" with PB cover	1/5
C60166	3" x 4" with PB cover & ring	1/5
C60143	4" with NB cover	1/5
C60147	4" with NB cover & ring	1/5
C60141	4" with PB cover	1/5
C60145	4" with PB cover & ring	1/5

General Purpose Access Fitting

3" x 4" Fits Over 3" or Inside 4" Schedule 40 DWV Pipe
 4" Fits Over 4" Schedule 40 DWV Pipe

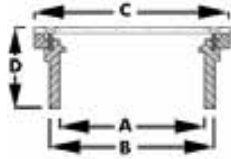

MADE IN THE
USA

• For use with internal pipe cleanout, order separately

A	B	C	D
Over 3"	Inside 4"	5-3/16"	2-1/2"
Over 4"	—	6-1/8"	2-1/2"

PVC

PART NO.	DESCRIPTION	CTN/MSTR
C60062	3" x 4" with NB cover	1/5
C60065	3" x 4" with NB cover & ring	1/5
C60060	3" x 4" with PB cover	1/5
C60064	3" x 4" with PB cover & ring	1/5
C60042	4" with NB cover	1/5
C60046	4" with NB cover & ring	1/5
C60040	4" with PB cover	1/5
C60044	4" with PB cover & ring	1/5

ABS

PART NO.	DESCRIPTION	CTN/MSTR
C60063	3" x 4" with NB cover	1/5
C60067	3" x 4" with NB cover & ring	1/5
C60061	3" x 4" with PB cover	1/5
C60066	3" x 4" with PB cover & ring	1/5
C60043	4" with NB cover	1/5
C60047	4" with NB cover & ring	1/5
C60041	4" with PB cover	1/5
C60045	4" with PB cover & ring	1/5

Snap-in Access Fitting

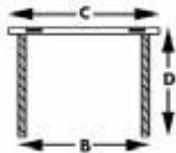

MADE IN THE
USA

A	B	C	D
3"	3-1/16"	3-1/2"	2"
4"	4"	4-1/2"	2"

PVC

PART NO.	DESCRIPTION	CTN/MSTR
C60013	3" with SS strainer	1/20
C60014	4" with SS strainer	1/20

Sewer Relief Plug



- High-density construction
- Eliminates costly damages caused by sewer back-up
- Spring-loaded to close automatically to eliminate sewer gas
- Made of ABS

MADE IN THE
USA

PART NO.	DESCRIPTION	CTN/MSTR
S25150	1-1/2" sewer relief plug	1/50
S25200	2" sewer relief plug	1/50
S25250	2-1/2" sewer relief plug	1/100
S25300	3" sewer relief plug	1/100
S25350	3-1/2" sewer relief plug	1/100
S25400	4" sewer relief plug	1/100

Test Tee with Plug



- Easy pop top test
- PVC plug included
- Test up to 3 floors

MADE IN THE
USA

PART NO.	DESCRIPTION	CTN/MSTR
C67450	2" test tee	1/10
C67451	3" test tee	1/12

PVC Internal Cleanout with SS Cover



PART NO.	DESCRIPTION	CTN/MSTR
C60015	3" with 5" SS external wall cover	1/1
C60016	4" with 6" SS external wall cover	1/1

Saddle Tees and Kits



- Use bushing to reduce 2" unit to 1-1/2"
- Kits include V-bolts, nuts and washers
- Conversion kit also contains gasket mat for use with cast iron pipe
- Solvent branch

MADE IN THE
USA

PART NO.	DESCRIPTION	CTN/MSTR
S26014	3" x 2" Saddle tee only	1/20
S26015	4" x 2" Saddle tee only	1/10
S26016	4" x 3" Saddle tee only	1/10
S26017	4" x 4" Saddle tee only	1/10
S26004	3" x 2" Saddle tee kit less gasket	1/20
S26005	4" x 2" Saddle tee kit less gasket	1/10
S26006	4" x 3" Saddle tee kit less gasket	1/10
S26007	4" x 4" Saddle tee kit less gasket	1/10
S26009	3" x 2" Saddle tee conversion kit with gasket	1/20
S26010	4" x 2" Saddle tee conversion kit with gasket	1/10
S26011	4" x 3" Saddle tee conversion kit with gasket	1/10
S26012	4" x 4" Saddle tee conversion kit with gasket	1/10
S26008	6" x 7" x 1/4" closed cell foam gasket	1/20

PVC and ABS Adjustable Commercial Cleanouts

Pages 232-235

SIZES: 2" x 3", 3", 3" x 4", 4"



For use in applications where height adjustments are necessary.

4" Hub Fit Base with 3-1/2" Plastic Spud

Fits Inside 4" Schedule 40 DWV Pipe

MADE IN THE
USA

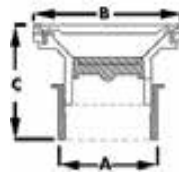

- Supplied with 3" IPS (3-1/2" OD) countersunk plug
- Covers available in PB and NB
- Covers are 3/16" thick
- Adjustable (see dimension C)

COVER	A	B	C
5" round	4" Hub fit	5-3/16"	3-1/8" - 4-5/8"
5" round with ring	4" Hub fit	5-1/2"	3-5/16" - 4-13/16"
6" round	4" Hub fit	6-1/8"	3-1/8" - 4-5/8"
6" round with ring	4" Hub fit	6-1/2"	3-5/16" - 4-13/16"
7" square	4" Hub fit	7"	3-3/8" - 4-15/16"

PVC

PART NO.	COVER	CTN/MSTR
C59200	5" PB round	1/1
C59201	5" PB round with ring	1/1
C59202	5" NB round	1/1
C59203	5" NB round with ring	1/1
C59001	6" PB round	1/1
C59005	6" PB round with ring	1/1
C59003	6" NB round	1/1
C59007	6" NB round with ring	1/1
C59050	7" PB square	1/1
C59052	7" NB square	1/1

ABS

PART NO.	COVER	CTN/MSTR
C59204	5" PB round	1/1
C59205	5" PB round with ring	1/1
C59206	5" NB round	1/1
C59207	5" NB round with ring	1/1
C59002	6" PB round	1/1
C59006	6" PB round with ring	1/1
C59004	6" NB round	1/1
C59008	6" NB round with ring	1/1
C59051	7" PB square	1/1
C59053	7" NB square	1/1

4" Hub Fit Base with 3-1/2" Metal Spud

Fits Inside 4" Schedule 40 DWV Pipe

MADE IN THE
USA

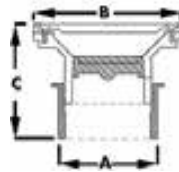

- Supplied with 3" IPS (3-1/2" OD) countersunk plug
- Covers available in PB and NB
- Covers are 3/16" thick
- Adjustable (see dimension C)

COVER	A	B	C
5" round	4" Hub fit	5-3/16"	3-1/4" - 4-1/4"

PVC

PART NO.	COVER	CTN/MSTR
C59060	5" PB round	1/1
C59062	5" NB round	1/1

ABS

PART NO.	COVER	CTN/MSTR
C59061	5" PB round	1/1
C59063	5" NB round	1/1

3" x 4" Pipe Fit Base with 3-1/2" Plastic Spud

Fits Over 3" or Inside 4" Schedule 40 DWV Pipe

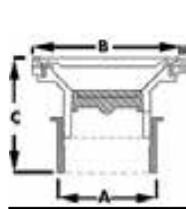

- Supplied with 3" IPS (3-1/2" OD) countersunk plug
- Covers available in PB and NB
- Covers are 3/16" thick
- Adjustable (see dimension C)

COVER	A	B	C
5" round	Over 3" Pipe Inside 4" Pipe	5-3/16"	3-1/8" - 4-5/8"
5" round with ring	Over 3" Pipe Inside 4" Pipe	5-1/2"	3-5/16" - 4-13/16"
6" round	Over 3" Pipe Inside 4" Pipe	6-1/8"	3-1/8" - 4-5/8"
6" round with ring	Over 3" Pipe Inside 4" Pipe	6-1/2"	3-5/16" - 4-13/16"
7" square	Over 3" Pipe Inside 4" Pipe	7"	5-15/16" - 7-1/2"

PVC

PART NO.	COVER	CTN/MSTR
C59216	5" PB round	1/1
C59217	5" PB round with ring	1/1
C59218	5" NB round	1/1
C59219	5" NB round with ring	1/1
C59010	6" PB round	1/1
C59014	6" PB round with ring	1/1
C59012	6" NB round	1/1
C59016	6" NB round with ring	1/1
C59054	7" PB square	1/1
C59056	7" NB square	1/1

ABS

PART NO.	COVER	CTN/MSTR
C59220	5" PB round	1/1
C59221	5" PB round with ring	1/1
C59222	5" NB round	1/1
C59223	5" NB round with ring	1/1
C59011	6" PB round	1/1
C59015	6" PB round with ring	1/1
C59013	6" NB round	1/1
C59017	6" NB round with ring	1/1
C59055	7" PB square	1/1
C59057	7" NB square	1/1

3" x 4" Pipe Fit Base with 3-1/2" Metal Spud

Fits Over 3" or Inside 4" Schedule 40 DWV Pipe

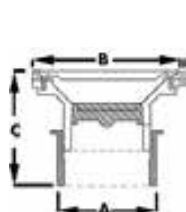

- Supplied with 3" IPS (3-1/2" OD) countersunk plug
- Covers available in PB and NB
- Covers are 3/16" thick
- Adjustable (see dimension C)

COVER	A	B	C
5" round	Over 3" Pipe Inside 4" Pipe	5-3/16"	5-3/4" - 7"

PVC

PART NO.	COVER	CTN/MSTR
C59068	5" PB round	1/1
C59070	5" NB round	1/1

ABS

PART NO.	COVER	CTN/MSTR
C59069	5" PB round	1/1
C59071	5" NB round	1/1

4" Over Pipe Fit Base with 3-1/2" Plastic Spud

Fits Over 4" Schedule 40 DWV Pipe

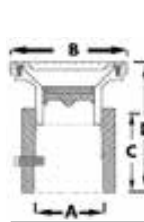

- Supplied with 3" IPS (3-1/2" OD) countersunk plug
- Covers available in PB and NB
- Covers are 3/16" thick
- Adjustable (see dimension D)

COVER	A	B	C	D
5" round	Over 4" Pipe	5-3/16"	4-1/4"	5-15/16" - 7-1/2"
5" round with ring	Over 4" Pipe	5-1/2"	4-1/4"	6-1/16" - 7-5/8"
6" round	Over 4" Pipe	6-1/8"	4-1/4"	5-15/16" - 7-1/2"
6" round with ring	Over 4" Pipe	6-1/2"	4-1/4"	6-1/16" - 7-5/8"
7" square	Over 4" Pipe	7"	4-1/4"	6-1/8" - 7-11/16"

PVC

PART NO.	COVER	CTN/MSTR
C59208	5" PB round	1/1
C59209	5" PB round with ring	1/1
C59210	5" NB round	1/1
C59211	5" NB round with ring	1/1
C60001	6" PB round	1/1
C60022	6" PB round with ring	1/1
C60020	6" NB round	1/1
C60024	6" NB round with ring	1/1
C60050	7" PB square	1/1
C60052	7" NB square	1/1

ABS

PART NO.	COVER	CTN/MSTR
C59212	5" PB round	1/1
C59213	5" PB round with ring	1/1
C59214	5" NB round	1/1
C59215	5" NB round with ring	1/1
C60003	6" PB round	1/1
C60023	6" PB round with ring	1/1
C60021	6" NB round	1/1
C60025	6" NB round with ring	1/1
C60051	7" PB square	1/1
C60053	7" NB square	1/1

4" Over Pipe Fit Base with 3-1/2" Metal Spud

Fits Over 4" Schedule 40 DWV Pipe

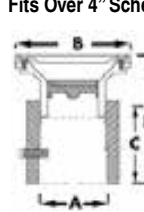

- Supplied with 3" IPS (3-1/2" OD) countersunk plug
- Covers available in PB and NB
- Covers are 3/16" thick
- Adjustable (see dimension D)

COVER	A	B	C	D
5" round	Over 4" Pipe	5"	4-1/4"	6" - 7-1/16"

PVC

PART NO.	COVER	CTN/MSTR
C59064	5" PB round	1/1
C59066	5" NB round	1/1

ABS

PART NO.	COVER	CTN/MSTR
C59065	5" PB round	1/1
C59067	5" NB round	1/1

4" Over Pipe Fit Base with 4" Plastic Spud

Fits Over 4" Schedule 40 DWV Pipe

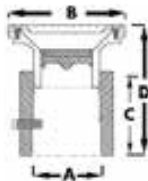

- Supplied with 3" IPS (3-1/2" OD) countersunk plug
- Covers available in PB and NB
- Covers are 3/16" thick
- Adjustable (see dimension D)

COVER	A	B	C	D
6" round	Over 4" Pipe	6"	4-3/4"	6-1/16" - 7-3/16"
6" round with ring	Over 4" Pipe	6-1/8"	4-3/4"	6-1/8" - 7-1/4"
7" square	Over 4" Pipe	7"	4-3/4"	6-3/16" - 7-3/8"

PVC

PART NO.	COVER	CTN/MSTR
C60070	6" PB round	1/1
C60071	6" PB round with ring	1/1
C60072	6" NB round	1/1
C60073	6" NB round with ring	1/1
C60075	7" NB square	1/1

ABS

PART NO.	COVER	CTN/MSTR
C60076	6" PB round	1/1
C60077	6" PB round with ring	1/1
C60078	6" NB round	1/1
C60079	6" NB round with ring	1/1
C60080	7" PB square	1/1
C60081	7" NB square	1/1

4" Over Pipe Fit Base with 4" Metal Spud

Fits Over 4" Schedule 40 DWV Pipe

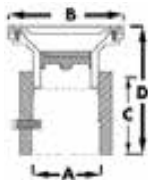

- 5" Supplied with 3" IPS (3-1/2" OD) countersunk plug
- 6" Supplied with 4" IPS plug
- Covers available in PB and NB
- Covers are 3/16" thick
- Adjustable (see dimension D)

COVER	A	B	C	D
5" round	Over 4" Pipe	5"	4-3/4"	5" - 6"
6" round	Over 4" Pipe	6"	4-3/4"	5" - 6"

PVC

PART NO.	COVER	CTN/MSTR
C60082	5" NB round	1/1
C60092	5" PB round	1/1
C60094	6" NB round	1/1
C60096	6" PB round	1/1

ABS

PART NO.	COVER	CTN/MSTR
C60083	5" NB round	1/1
C60095	6" NB round	1/1
C60097	6" PB round	1/1

3" Over Pipe Fit Base with 3" Plastic Spud

Fits Over 3" Schedule 40 DWV Pipe

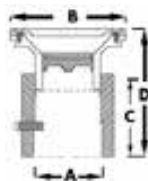

- Supplied with 2-1/2" IPS (3" OD) countersunk plug
- Covers available in PB and NB
- Covers are 3/16" thick
- Adjustable (see dimension D)

COVER	A	B	C	D
6" round	Over 3" Pipe	6-1/8"	4-1/2"	5-7/8" - 7-1/8"
6" round with ring	Over 3" Pipe	6-1/2"	4-1/2"	6" - 7-3/16"
7" square	Over 3" Pipe	7"	4-1/2"	6" - 7-3/16"

PVC

PART NO.	COVER	CTN/MSTR
C60026	6" PB round	1/1
C60030	6" PB round with ring	1/1
C60028	6" NB round	1/1
C60032	6" NB round with ring	1/1
C60054	7" PB square	1/1
C60056	7" NB square	1/1

ABS

PART NO.	COVER	CTN/MSTR
C60027	6" PB round	1/1
C60031	6" PB round with ring	1/1
C60029	6" NB round	1/1
C60033	6" NB round with ring	1/1
C60055	7" PB square	1/1
C60057	7" NB square	1/1

3" Over Pipe Fit Base with 3" Metal Spud

Fits Over 3" Schedule 40 DWV Pipe

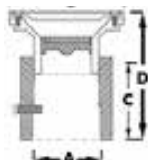

- Supplied with 2-1/2" IPS (3" OD) countersunk plug
- Covers available in PB, NB and CP
- Covers are 3/16" thick
- Adjustable (see dimension D)

COVER	A	B	C	D
5" round	Over 3" Pipe	5-3/16"	4-1/2"	5" - 6"

PVC

PART NO.	COVER	CTN/MSTR
C60086	5" PB round	1/1
C60084	5" NB round	1/1
C60088	5" CP round	1/1

ABS

PART NO.	COVER	CTN/MSTR
C60087	5" PB round	1/1
C60085	5" NB round	1/1
C60089	5" CP round	1/1

4" Inside Pipe Fit Base with 3" Plastic Spud

Fits Inside 4" Schedule 40 DWV Pipe

MADE IN THE USA

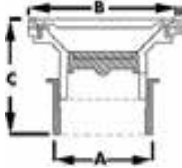

- Supplied with 3" IPS (3-1/2" OD) countersunk plug
- Covers available in PB and NB
- Covers are 3/16" thick
- Adjustable (see dimension C)

COVER	A	B	C
6" round	Inside 4" Pipe	6-1/8"	3-7/8" - 4-5/8"
6" round with ring	Inside 4" Pipe	6-1/2"	4" - 4-3/4"
7" square	Inside 4" Pipe	7"	4" - 4-7/8"

PVC

PART NO.	COVER	CTN/MSTR
C59020	6" PB round	1/1
C59024	6" PB round with ring	1/1
C59022	6" NB round	1/1
C59026	6" NB round with ring	1/1
C59028	7" PB square	1/1
C59030	7" NB square	1/1

ABS

PART NO.	COVER	CTN/MSTR
C59021	6" PB round	1/1
C59025	6" PB round with ring	1/1
C59023	6" NB round	1/1
C59027	6" NB round with ring	1/1
C59029	7" PB square	1/1
C59031	7" NB square	1/1

4" Inside Pipe Fit Base with 3" Metal Spud

Fits Inside 4" Schedule 40 DWV Pipe

MADE IN THE USA

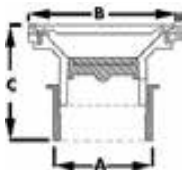

- Supplied with 3" IPS (3-1/2" OD) countersunk plug
- Covers available in PB, NB and CP
- Covers are 3/16" thick
- Adjustable (see dimension C)

COVER	A	B	C
5" round	Inside 4" Pipe	5"	2-7/16" - 3-1/2"

PVC

PART NO.	COVER	CTN/MSTR
C59090	5" NB round	1/1
C59092	5" PB round	1/1
C59094	5" CP round	1/1

ABS

PART NO.	COVER	CTN/MSTR
C59091	5" NB round	1/1
C59093	5" PB round	1/1
C59095	5" CP round	1/1

2" x 3" Cleanout with 2" Plastic Spud

Fits Over 2" or Inside 3" Schedule 40 DWV Pipe

MADE IN THE USA

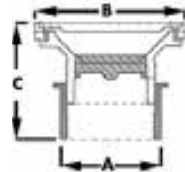

- Supplied with 2" t-cone test plug installed
- Covers available in PB and NB
- Covers are 3/16" thick
- Adjustable (see dimension C)

COVER	A	B	C
4" round	2"	4-1/4"	3-3/8" - 3-13/16"
4" round with ring	2"	4-1/2"	3-1/2" - 3-7/8"

PVC

PART NO.	COVER	CTN/MSTR
C59096	4" PB round	1/1
C59097	4" PB round with ring	1/1
C59098	4" NB round	1/1
C59099	4" NB round with ring	1/1

ABS

PART NO.	COVER	CTN/MSTR
C59100	4" PB round	1/1
C59101	4" PB round with ring	1/1
C59102	4" NB round	1/1
C59103	4" NB round with ring	1/1

E

PVC and ABS Commercial Cleanout Components

Pages 236-237

SIZES: 2", 3", 3-1/2", 4"

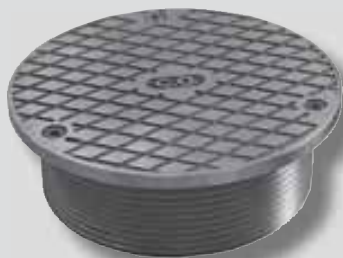

For use in
commercial applications.

E

2" Plastic Spud with Round Cover



• Supplied with 2" IPS / 2-1/2" OD
countersunk t-cone test plug



PVC

PART NO.	IPS	COVER	CTN/MSTR
D59920	2"	4" PB	1/1
D59921	2"	4" PB with ring	1/1
D59922	2"	4" NB	1/1
D59923	2"	4" NB with ring	1/1

ABS

PART NO.	IPS	COVER	CTN/MSTR
D59924	2"	4" PB	1/1
D59925	2"	4" PB with ring	1/1
D59926	2"	4" NB	1/1
D59927	2"	4" NB with ring	1/1

3" Plastic Spud with Round Cover



• Supplied with 2-1/2" IPS / 3" OD
countersunk plug



PVC

PART NO.	IPS	COVER	CTN/MSTR
D59904	3"	6" PB	1/1
D59908	3"	6" PB with ring	1/1
D59905	3"	6" NB	1/1
D59909	3"	6" NB with ring	1/1

ABS

PART NO.	IPS	COVER	CTN/MSTR
D57904	3"	6" PB	1/1
D57908	3"	6" PB with ring	1/1
D57905	3"	6" NB	1/1
D57909	3"	6" NB with ring	1/1

3" Metal Spud with Round Cover



• Supplied with 2-1/2" IPS / 3" OD
countersunk plug



PART NO.	IPS	COVER	CTN/MSTR
C37801	3"	5" PB	1/20
C37803	3"	5" NB	1/20
C37800	3"	5" CP	1/20

3" Plastic Spud with Square Cover



• Supplied with 2-1/2" IPS / 3" OD
countersunk plug



PVC

PART NO.	IPS	COVER	CTN/MSTR
D59912	3"	7" PB	1/1
D59913	3"	7" NB	1/1

ABS

PART NO.	IPS	COVER	CTN/MSTR
D57912	3"	7" PB	1/1
D57913	3"	7" NB	1/1

3-1/2" Plastic Spud with Round Cover



• Supplied with 3" IPS countersunk plug



PVC

PART NO.	IPS	COVER	CTN/MSTR
D59943	3-1/2"	5" PB	1/1
D59944	3-1/2"	5" PB with ring	1/1
D59945	3-1/2"	5" NB	1/1
D59946	3-1/2"	5" NB with ring	1/1
D59901	3-1/2"	6" PB	1/1
D59906	3-1/2"	6" PB with ring	1/1
D59902	3-1/2"	6" NB	1/1
D59907	3-1/2"	6" NB with ring	1/1

ABS

PART NO.	IPS	COVER	CTN/MSTR
D59947	3-1/2"	5" PB	1/1
D59948	3-1/2"	5" PB with ring	1/1
D59949	3-1/2"	5" NB	1/1
D59950	3-1/2"	5" NB with ring	1/1
D57901	3-1/2"	6" PB	1/1
D57906	3-1/2"	6" PB with ring	1/1
D57902	3-1/2"	6" NB	1/1
D57907	3-1/2"	6" NB with ring	1/1

3-1/2" Metal Spud with Round Cover



• Supplied with 3-1/2" IPS countersunk plug



PART NO. IPS COVER CTN/MSTR

C37811	3-1/2"	5" PB	1/18
C37810	3-1/2"	5" NB	1/18

3-1/2" Plastic Spud with Square Cover



• Supplied with 3" IPS countersunk plug



PVC

PART NO.	IPS	COVER	CTN/MSTR
D59910	3-1/2"	7" PB	1/1
D59911	3-1/2"	7" NB	1/1

ABS

PART NO.	IPS	COVER	CTN/MSTR
D57910	3-1/2"	7" PB	1/1
D57911	3-1/2"	7" NB	1/1

4" Plastic Spud with Round Cover



• Supplied with 3" IPS countersunk plug



PVC

PART NO.	IPS	COVER	CTN/MSTR
D59914	4"	6" PB	1/1
D59915	4"	6" PB with ring	1/1
D59916	4"	6" NB	1/1
D59917	4"	6" NB with ring	1/1

ABS

PART NO.	IPS	COVER	CTN/MSTR
D57914	4"	6" PB	1/1
D57915	4"	6" PB with ring	1/1
D57916	4"	6" NB	1/1
D57917	4"	6" NB with ring	1/1

4" Metal Spud with Round Cover



• 5" Cover supplied with 3-1/2" IPS countersunk plug
• 6" Cover supplied with 4" IPS countersunk plug



PART NO. IPS COVER CTN/MSTR

C37806	4"	5" PB	1/20
C37805	4"	5" NB	1/20
C37808	4"	6" PB	1/8
C37807	4"	6" NB	1/8

4" Plastic Spud with Square Cover



• Supplied with 3" IPS countersunk plug



PVC

PART NO.	IPS	COVER	CTN/MSTR
D59918	4"	7" PB	1/1
D59919	4"	7" NB	1/1

ABS

PART NO.	IPS	COVER	CTN/MSTR
D57918	4"	7" PB	1/1
D57919	4"	7" NB	1/1

Covers



• 4" Fits 4-1/4" diameter drain and cleanout spuds, D50 (2" x 3") series shower drains and 2" x 3" General Purpose Drains
• 5" Fits 5" diameter drain and cleanout spuds and 3" x 4" General Purpose Drains
• 6" Fits 6-1/8" diameter drain and cleanout spuds and 4" General Purpose Drains
• Includes screws

PART NO. SIZE DESCRIPTION CTN/MSTR

C60504	4"	NB cast	1/50
C60505	4"	PB cast	1/50
C60503	5"	NB cast	1/50
C60502	5"	PB cast	1/50
C60501	6"	NB cast	1/30
C60500	6"	PB cast	1/30

Round Slop Sink

Fits Over 3" or Inside 4" Pipe

MADE IN THE **USA**

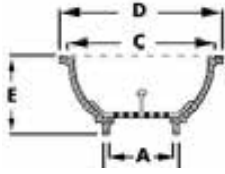

- 4-7/8" OD scoop strainer with stem for easy removal
- 12" diameter

A	B	C	D	E
3"	4"	11"	12"	6-3/8"

PART NO.	DESCRIPTION	CTN/MSTR
S55001	3" x 4" PVC sink and strainer	1/1
S55002	Replacement strainer	1/1

Floor Sink

To Be Used with Coupling or Hub Kit

MADE IN THE **USA**

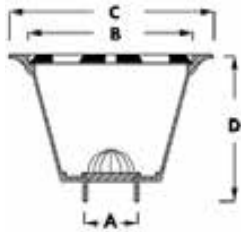

- 3/4" thick top grate in three styles
- 12" x 12" top flange

A	B	C	D
Inside 2" fitting	9-3/16"	12"	8"
Inside 3" fitting	9-3/16"	12"	8"
Inside 4" fitting	9-3/16"	12"	8"

PVC

PART NO.	DESCRIPTION	CTN/MSTR
S59002	2" sink only	1/1
S59003	3" sink only	1/1
S59004	4" sink only	1/1

ABS

PART NO.	DESCRIPTION	CTN/MSTR
S59302	2" sink only	1/1
S59303	3" sink only	1/1
S59304	4" sink only	1/1

Complete PVC Floor Sink Kit

MADE IN THE **USA**



- Includes sink, top grate and bottom strainer
- To be used with coupling or hub kit

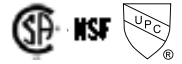

PART NO.	DESCRIPTION	CTN/MSTR
S49042	2" - 1/2 top grate - dome bottom grate	1/1
S49052	2" - 3/4 top grate - dome bottom grate	1/1
S49062	2" - full top grate - dome bottom grate	1/1
S49072	2" - 1/2 top grate - flat bottom grate	1/1
S49082	2" - 3/4 top grate - flat bottom grate	1/1
S49092	2" - full top grate - flat bottom grate	1/1
S49043	3" - 1/2 top grate - dome bottom grate	1/1
S49053	3" - 3/4 top grate - dome bottom grate	1/1
S49063	3" - full top grate - dome bottom grate	1/1
S49073	3" - 1/2 top grate - flat bottom grate	1/1
S49083	3" - 3/4 top grate - flat bottom grate	1/1
S49093	3" - full top grate - flat bottom grate	1/1
S49044	4" - 1/2 top grate - dome bottom grate	1/1
S49054	4" - 3/4 top grate - dome bottom grate	1/1
S49064	4" - full top grate - dome bottom grate	1/1
S49074	4" - 1/2 top grate - flat bottom grate	1/1
S49084	4" - 3/4 top grate - flat bottom grate	1/1
S49094	4" - full top grate - flat bottom grate	1/1

Pipe Fit Floor Sink

2" x 3" Fits Over 2" or Inside 3" Schedule 40 DWV Pipe
 3" x 4" Fits Over 3" or Inside 4" Schedule 40 DWV Pipe
 4" Fits Over 4" Schedule 40 DWV Pipe

MADE IN THE **USA**

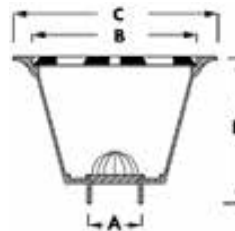

- 3/4" thick top grate in three styles
- 12" x 12" top flange
- Temp up to 180°

A	B	C	D
Over 2" Inside 3"	9-3/16"	12"	8"
Over 3" Inside 4"	9-3/16"	12"	8"
Over 4"	9-3/16"	12"	8"

PVC

PART NO.	DESCRIPTION	CTN/MSTR
S59102	2" x 3" sink only	1/1
S59103	3" x 4" sink only	1/1
S59104	4" sink only	1/1

ABS

PART NO.	DESCRIPTION	CTN/MSTR
S59402	2" x 3" sink only	1/1
S59403	3" x 4" sink only	1/1

Complete PVC Floor Sink Kit-Pipe Fit



- Includes sink, top grate and bottom strainer



PART NO.	DESCRIPTION	CTN/MSTR
S59042	2"x 3" - 1/2 top grate - dome bottom grate	1/1
S59052	2"x 3" - 3/4 top grate - dome bottom grate	1/1
S59062	2"x 3" - full top grate - dome bottom grate	1/1
S59072	2"x 3" - 1/2 top grate - flat bottom grate	1/1
S59082	2"x 3" - 3/4 top grate - flat bottom grate	1/1
S59092	2"x 3" - full top grate - flat bottom grate	1/1
S59043	3"x 4" - 1/2 top grate - dome bottom grate	1/1
S59053	3"x 4" - 3/4 top grate - dome bottom grate	1/1
S59063	3"x 4" - full top grate - dome bottom grate	1/1
S59073	3"x 4" - 1/2 top grate - flat bottom grate	1/1
S59083	3"x 4" - 3/4 top grate - flat bottom grate	1/1
S59093	3"x 4" - full top grate - flat bottom grate	1/1
S59044	4" - 1/2 top grate - dome bottom grate	1/1
S59054	4" - 3/4 top grate - dome bottom grate	1/1
S59064	4" - full top grate - dome bottom grate	1/1
S59074	4" - 1/2 top grate - flat bottom grate	1/1
S59084	4" - 3/4 top grate - flat bottom grate	1/1
S59094	4" - full top grate - flat bottom grate	1/1

Full Top Grate for Floor Sink



- Accessories for all S49 and S59 series floor sinks



PVC		
PART NO.	DESCRIPTION	CTN/MSTR
S59010	Full top grate	1/10

ABS		
PART NO.	DESCRIPTION	CTN/MSTR
S59310	Full top grate	1/10

Three-Quarters Top Grate for Floor Sink



- Accessories for all S49 and S59 series floor sinks



PVC		
PART NO.	DESCRIPTION	CTN/MSTR
S59011	3/4 top grate	1/10

ABS		
PART NO.	DESCRIPTION	CTN/MSTR
S59311	3/4 top grate	1/10

Half Top Grate for Floor Sink



- Accessories for all S49 and S59 series floor sinks



PVC		
PART NO.	DESCRIPTION	CTN/MSTR
S59012	1/2 top grate	1/10

ABS		
PART NO.	DESCRIPTION	CTN/MSTR
S59312	1/2 top grate	1/10

Aluminum Dome Strainer for Floor Sink



- Accessories for all S49 and S59 series floor sinks

PART NO.	DESCRIPTION	CTN/MSTR
S60002	2" aluminum dome bottom strainer	1/10
S60003	3" aluminum dome bottom strainer	1/10
S60004	4" aluminum dome bottom strainer	1/10

Flat Aluminum Bottom Strainer for Floor Sink



- Accessories for all S49 and S59 series floor sinks

PART NO.	DESCRIPTION	CTN/MSTR
S60005	Flat aluminum bottom strainer	1/10

Backwater Valve

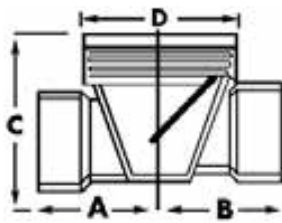

MADE IN THE USA
UPC NSF

- Sockets are Schedule 40 DWV
- Reduces backflow in drainage system
- Threaded access cover for easy inspection
- Magnetic strip for underground detection
- Flapper and cover have elastomeric gasket to ensure watertight seal
- Stepped construction encourages flow (minimum 1/4" per foot fall)
- The 1-1/2", 2" and 6" have UPC, SBCCI and CSA listings
- The 3" and 4" are NSF and UPC listed

A	B	C	D
1/2"	2-3/16"	2"	4"
2"	2-7/16"	3-7/8"	4"
3"	3-7/8"	5-1/2"	6"
4"	5-3/8"	6-3/4"	8"
6"	7-3/4"	9-1/4"	10-3/4"

PVC

PART NO.	DESCRIPTION	CTN/MSTR
B04150	1-1/2" backwater valve	1/1
B04200	2" backwater valve	1/1
B04300	3" backwater valve	1/1
B04400	4" backwater valve	1/1
B04600	6" backwater valve	1/1

ABS

PART NO.	DESCRIPTION	CTN/MSTR
B05150	1-1/2" backwater valve	1/1
B05200	2" backwater valve	1/1
B05300	3" backwater valve	1/1
B05400	4" backwater valve	1/1
B05600	6" backwater valve	1/1



- Extension kit includes 16" sleeve, lid and adapter
- Sockets are Schedule 40 DWV
- Reduces backflow in drainage system
- Threaded access cover for easy inspection
- Magnetic strip for underground detection
- Flapper and cover have elastomeric gasket to ensure watertight seal
- Stepped construction encourages flow (minimum 1/4" per foot fall)
- The 1-1/2", 2" and 6" have UPC, SBCCI and CSA listings
- The 3" and 4" are NSF and UPC listed

MADE IN THE USA
UPC NSF

PVC

PART NO.	DESCRIPTION	CTN/MSTR
B04150K	1-1/2" with extension kit & CI lid	1/1
B04200K	2" with extension kit & CI lid	1/1
B04300K	3" with extension kit & CI lid	1/1
B04400K	4" with extension kit & CI lid	1/1
B04151K	1-1/2" with extension kit & plastic lid	1/1
B04201K	2" with extension kit & plastic lid	1/1
B04301K	3" with extension kit & plastic lid	1/1
B04401K	4" with extension kit & plastic lid	1/1

ABS

PART NO.	DESCRIPTION	CTN/MSTR
B05150K	1-1/2" with extension kit & CI lid	1/1
B05200K	2" with extension kit & CI lid	1/1
B05300K	3" with extension kit & CI lid	1/1
B05400K	4" with extension kit & CI lid	1/1

Flapper with Gasket for Backwater Valve



PART NO.	DESCRIPTION	CTN/MSTR
B04201	Fits 1-1/2" & 2" backwater valve	1/1
B04301	Fits 3" backwater valve	1/1
B04401	Fits 4" backwater valve	1/1

Extension Kit



- Kit includes cast iron top, 16" sleeve and adapter

MADE IN THE USA

PART NO.	DESCRIPTION	CTN/MSTR
B04303	3" complete kit with CI lid	1/1
B04403	4" complete kit with CI lid	1/1
B04304	3" complete kit with plastic lid	1/1
B04404	4" complete kit with plastic lid	1/1
BWV200	Ring adapter for 1-1/2" and 2"	1/1
BWV300	Ring adapter for 3"	1/1
BWV400	Ring adapter for 4"	1/1
B04006	6" CI lid for 3" (fits 6" pipe)	1/1
B04008	8" CI lid for 4" (fits 8" pipe)	1/1

Cover for PVC and ABS Pipe



- Covers 6" or 8" PVC and ABS pipe

PART NO.	DESCRIPTION	CTN/MSTR
B04007	6" plastic lid marked "water" (fits 6" pipe)	1/1
B04006	6" cast iron lid marked "sewer" (fits 6" pipe)	1/1
B04008	8" cast iron lid "sewer" (fits 8" pipe)	1/1

Condensate Trap



- Manufactured of Schedule 40 DWV pipe
- One-piece design

PART NO.	DESCRIPTION	CTN/MSTR
P15050	1/2" p-trap	1/100
P15075	3/4" p-trap	1/100
P15175	3/4" mini p-trap	1/250
R15050	1/2" running trap	1/100
R15075	3/4" running trap	1/100

Items marked with the Jones Stephens logo are "You Need It... We Got It" Items.

Mushroom Vent Cap

Fits 3" or 4" Vent Stacks



- Gray PVC construction
- Includes three installation screws

MADE IN THE
USA

PART NO.	DESCRIPTION	CTN/MSTR
M05034	3" x 4" mushroom vent cap	1/20

Flat Top Vent Cap



- White PVC construction
- Fits 3" and 4" vent stacks
- Includes 2 set screws for securing cap

MADE IN THE
USA

PART NO.	DESCRIPTION	CTN/MSTR
M05134	Flat top vent cap	1/20

PVC Coupling



- Connects 4" Schedule 40 DWV pipe to 4" SDR

MADE IN THE
USA

PART NO.	DESCRIPTION	CTN/MSTR
C67440	4" DWV x 4" SDR coupling	1/10

PVC Multi-Use Coupling



- Use to reduce or increase variety of sizes of Schedule 40 pipe

MADE IN THE
USA

PART NO.	DESCRIPTION	CTN/MSTR
C67230	2" x 3" coupling	1/1
C67340	3" x 4" coupling	1/1

Spigot Adapter



MADE IN THE
USA

PART NO.	DESCRIPTION	CTN/MSTR
C67445	4" DWV x 4" SDR spigot	1/1

Plastic Over-Fitting Repair Fitting



MADE IN THE
USA

- More efficient and less costly way to handle many common PVC re-piping problems
- Available in 1-1/2", 2", 3" and 4" PVC
- Compatible with all fittings
- Raised lettering on hub actually helps seal chemical bond
- Glues over the hub of a fitting on one end and is a 1-1/2" or 2" hub on the other end

PVC

PART NO.	DESCRIPTION	CTN/MSTR
P22100	1-1/2" repair fitting	1/1
P22200	2" repair fitting	1/1
P22300	3" repair fitting	1/1

ABS

PART NO.	DESCRIPTION	CTN/MSTR
P22101	1-1/2" repair fitting	1/1
P22201	2" repair fitting	1/1



Roof Drain with Cast Iron Dome

Fits over Schedule 40 DWV Pipe

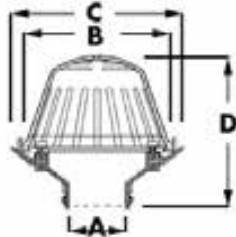

- Brass inserts in underside for underdeck clamps
- Dome has 50 square inches of free area

	A	B	C	D
Over 2" pipe		8-1/4"	11"	9"
Over 3" pipe		8-1/4"	11"	9"
Over 4" pipe		8-1/4"	11"	9"
Over 6" pipe		8-1/4"	11"	8"

PVC

PART NO.	DESCRIPTION	CTN/MSTR
R18001	2" cast iron dome	1/1
R18005	3" cast iron dome	1/1
R18006	4" cast iron dome	1/1
R18026	6" cast iron dome	1/1

E

ABS

PART NO.	DESCRIPTION	CTN/MSTR
R18009	2" cast iron dome	1/1
R18007	3" cast iron dome	1/1
R18008	4" cast iron dome	1/1

Accessories for Roof Drains



PART NO.	DESCRIPTION	CTN/MSTR
R18011	2", 3" & 4" underdeck clamp	1/1
R18028	6" underdeck clamp	1/10
R18012	16" plastic receiving pan	1/1
R18019	Plastic roof dome	1/1
R18020	Cast iron roof dome	1/1

Roof Drain with Plastic Dome

Fits over Schedule 40 DWV Pipe

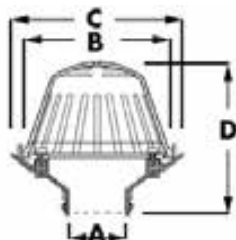

- Brass inserts in underside for underdeck clamps
- Dome has 50 square inches of free area

	A	B	C	D
Over 2" pipe		8-1/4"	11"	8"
Over 3" pipe		8-1/4"	11"	8"
Over 4" pipe		8-1/4"	11"	8"
Over 6" pipe		8-1/4"	11"	8"

PVC

PART NO.	DESCRIPTION	CTN/MSTR
R18013	2" plastic dome	1/1
R18014	3" plastic dome	1/1
R18015	4" plastic dome	1/1
R18027	6" plastic dome	1/1

ABS

PART NO.	DESCRIPTION	CTN/MSTR
R18016	2" plastic dome	1/1
R18017	3" plastic dome	1/1
R18018	4" plastic dome	1/1

CAST IRON

Closet Flanges and Accessories 245-246

Residential Shower/Floor Drains 247-249

Assembled Cast Iron Drains 250-254

Drain Bodies..... 255

Spuds and Strainers 256-257

General Purpose Drains..... 258-259

Assembled Cleanouts..... 260-263

Cleanout Bodies and Spuds..... 264-265

Cleanout Plugs 266-267

Cleanout Cover Plates..... 268

Bell Traps..... 269

Floor and Cesspool Drains/Grates 270

Service Sinks and Accessories 271

Roof Drains..... 272

Bar Grates/Sewer Strainers and Boxes 273

Vent Boxes/Caps/Backwater Valves 274

Test Tees and Closet Bends 275

Gas Burners/Log Lighter Valves/Accessories 276-277

F

*Published March 2017. List prices can be found in list price book and on our website.

Cast Iron Two Finger Flange



- Patent #: 5,937,450
- Flush fit
- Redesigned to fit oblong horns
- Made of cast iron
- Pushes easily into cast iron or Schedule 40 DWV pipe
- No tear out or caulking required
- ASTM C-564 rubber gasket
- 3" x 2", 4" x 2" and 4" x 3": for areas with the bend close to the flange
- 3" x 4", 4" x 4" and 4" x 6": for areas without the bend close to the flange or broken pipe



PART NO.	DESCRIPTION	CTN/MSTR
C47320	3" x 2" CI two finger flange	1/8
C47340	3" x 4" CI two finger flange	1/4
C47420	4" x 2" CI two finger flange	1/8
C47430	4" x 3" CI two finger flange	1/4
C47440	4" x 4" CI two finger flange	1/4
C47460	4" x 6" CI two finger flange	1/2

Inside Caulk Closet Flange



- Notched and slotted
- Inside caulk connection



Service Weight

PART NO.	DESCRIPTION	CTN/MSTR
C41410	4" x 1" inside caulk	1/10
C41411	4" x 1-1/2" inside caulk	1/10
C41420	4" x 2" inside caulk	1/8
C41421	4" x 2-1/2" inside caulk	1/8
C41430	4" x 3" inside caulk	1/6
C41440	4" x 4" inside caulk	1/4
C41460	4" x 6" inside caulk	1/2

Extra Heavy - 5" I.D. - NO BEAD

PART NO.	DESCRIPTION	CTN/MSTR
C42421	4" x 2-1/2" inside caulk	1/8
C42440	4" x 4" inside caulk	1/4
C42460	4" x 6" inside caulk	1/2

Inside Caulk Reducing Closet Flange



- Notched and slotted
- Inside caulk connection



PART NO.	DESCRIPTION	CTN/MSTR
C45433	4" inlet x 3" outlet x 3" depth	1/6

No Caulk Closet Flange with Test Cap



- Slotted
- Stainless bolts and washers

PART NO.	DESCRIPTION	CTN/MSTR
C40425	4" x 2" no caulk	1/8

Code Blue No Caulk Closet Flange



- Four stainless bolts and washers
- Neoprene gasket meets ASTM C564
- Ideal for both repair and new construction
- Easy to install- reduces installation time by 80%
- Push over cast iron or plastic pipe, anchor to floor and tighten bolts
- C40420, C40430, and C40440 are UPC listed



PART NO.	DESCRIPTION	CTN/MSTR
C40320	3" pipe x 2" depth	1/8
C40420	4" pipe x 2" depth	1/8
C40430	4" pipe x 3" depth	1/4
C40440	4" pipe x 4" depth	1/4

Code Blue No Caulk Closet Flange with Test Cap



- Cut out neoprene test cap
- Stainless steel bolts



PART NO.	DESCRIPTION	CTN/MSTR
C40500	4" x 2" no caulk	1/8
C40503	3" x 3" no caulk	1/8

No Hub Closet Flange



- Notched and slotted
- C46331 and C46351 are UPC listed



PART NO.	DESCRIPTION	CTN/MSTR
C46331	3" x 3-1/2" no hub	1/6
C46431	4" x 3-1/2" no hub	1/6
C46351	3" x 5-1/2" no hub	1/6
C46451	4" x 5-1/2" no hub	1/6

Items marked with the Jones Stephens logo are "You Need It...We Got It" Items.

2" Offset Closet Flange



PART NO.	DESCRIPTION	CTN/MSTR
C43440	4" x 4" x 2" inside caulk	1/4
C43441	4" x 4" x 2" no hub	1/4

Code Blue 1" Offset Closet Flange



- 5/16" bolt slots
- IAPMO listed



PART NO.	DESCRIPTION	CTN/MSTR
C40640	4" no caulk	1/4

F

Four Way Offset Closet Flange



- 1-1/2" offset
- Internal clip allows 360° offset capability

PART NO.	DESCRIPTION	CTN/MSTR
C44420	4 "x 2" inside caulk	1/8
C44440	4" x 4" inside caulk	1/4

Brass Closet Flange



PART NO.	DESCRIPTION	CTN/MSTR
C49440	14 oz.	1/50
C49441	Deep seal 1-1/8"	1/50
C49442	16 oz.	1/50

Brass Four Way Offset Closet Flange



- Clip allows four way 1-1/2" offset
- For use with lead bends

PART NO.	DESCRIPTION	CTN/MSTR
C49421	4" x 2" 4-way offset closet flange	1/40

Closet Flange Repair Ring



- Securely attaches to concrete or wood sub-floor
- Replaces most closet rings
- Corrosion resistant
- Mounting ears offset by 1/8" to allow closet bolts to be installed

PART NO.	DESCRIPTION	CTN/MSTR
C85000	Closet flange repair ring	20/80

Moss Bay Repair Flange



- For corroded and rusted toilet flanges
- Installs in minutes
- Galvanized

PART NO.	DESCRIPTION	CTN/MSTR
C85500	Moss bay repair flange	1/50

Gapper Flange



- Used to repair broken closet flanges
- Individually carded

PART NO.	DESCRIPTION	CTN/MSTR
C87100	Repair flange (carded)	24/240

Flange Support for Wood Floors



- Supports flange if floor has rotted or if rough-in hole is too large
- Easy to install- complete kit includes screws
- Made of steel
- Individually carded

PART NO.	DESCRIPTION	CTN/MSTR
C01001	Fits 3", 4", or 3"x4" plastic flange	1/50
C01002	Fits 3" or 4" cast iron flange	1/50

Items marked with the Jones Stephens logo are "You Need It...We Got It" Items.

Cast Iron Residential Shower/Floor Drains

Pages 247-249

SIZES: 1-1/2", 2"



For use in residential applications.

1-1/2" or 2" Code Blue EZ Test Shower Drain



- Includes cover plate and stainless steel screws
- Nipple not included
- D64012 and D64302 are UPC approved

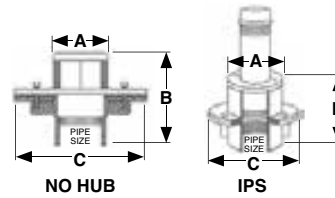

PIPE SIZE	A	B	C
1-1/2"	3-1/2"	4-1/4"	6"
2"	3-1/2"	4-1/4"	7"

PART NO.	SIZE	BASE	STRAINER	CTN/MSTR
D64150	1-1/2" IPS	6"	SS	1/4
D64202	2" IPS	6"	SS	1/4
D64012	2" IPS	7"	SS	1/4
D64302	2" no hub	6"	SS	1/4

2" Code Blue Shower Drain



- Includes cover plate and stainless steel screws
- No caulk includes built-in test plug
- D64002 and D64022 are UPC approved

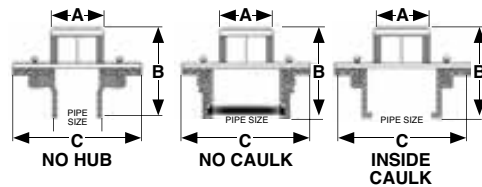

PIPE SIZE	A	B	C
2"	3-1/2"	4-1/4"	6"
2"	3-1/2"	4-1/4"	7"

PART NO.	SIZE	BASE	STRAINER	CTN/MSTR
D64502	2" no caulk	6"	SS	1/4
D64002	2" no caulk	7"	SS	1/4
D64022	2" no hub	7"	SS	1/4

2" Code Blue Roman Tub Drain



- 6" and 7" pans
- Non-adjustable

PART NO.	SIZE	BASE	FINISH	CTN/MSTR
D64800	2" IPS	7"	CP (PVD)	1/1
D64801	2" no caulk	7"	CP (PVD)	1/1
D64802	2" IPS	6"	CP (PVD)	1/1
D64803	2" no caulk	6"	CP (PVD)	1/1
D64804	2" IPS	7"	PB (PVD)	1/1
D64805	2" no caulk	7"	PB (PVD)	1/1
D64806	2" IPS	6"	PB (PVD)	1/1
D64807	2" no caulk	6"	PB (PVD)	1/1
D64808	2" IPS	7"	SN (PVD)	1/1
D64809	2" no caulk	7"	SN (PVD)	1/1
D64810	2" IPS	6"	SN (PVD)	1/1
D64811	2" no caulk	6"	SN (PVD)	1/1

Items marked with the Jones Stephens logo are "You Need It...We Got It" Items.

Code Blue Replacement Strainer



- Roman tub drains
- Fits non-adjustable Code Blue drains

PART NO.	DESCRIPTION	CTN/MSTR
D40000	CP strainer	1/50
D40001	PB (PVD) strainer	1/50
D40002	SN (PVD) strainer	1/50

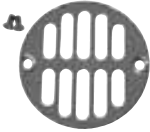

- Regular strainer
- Fits non-adjustable Code Blue drains
- Will not fit D64010 or D64011
- Includes screws

PART NO.	DESCRIPTION	CTN/MSTR
D64000	2" SS	1/50
D64401	2" SS crown	1/400
D64001	2" PB (PVD)	1/100
D6400BN	2" Brushed Nickel	1/250
D6400RB	2" Oil Rubbed Bronze	1/250
D6400WB	2" Old World Bronze	1/250

F

2" Code Blue Non-Adjustable Drain



- With ABS base and cast iron top

PART NO.	TOP	BASE	CTN/MSTR
D64010	Cast Iron	ABS base	1/8
D64011 (with test cap)	Cast Iron	ABS base	1/8

2" Shower/Floor Drain



- Brass spud
- 6-1/2" pan
- Tongue and groove cast iron bolt down clamping ring
- Weep holes on both top and bottom for secondary drainage
- Inside caulk unit can be used with gasket to make unit no-caulk

PART NO.	SIZE	STRAINER	CTN/MSTR
D60100	2" inside caulk	4" SS round	1/8
D60102	2" FIP	4" SS round	1/8
D60103	2" no hub	4" SS round	1/8
D60201	2" inside caulk	4" CP cast round	1/8
D60202	2" inside caulk	4" PB cast round	1/8
D60203	2" FIP	4" CP cast round	1/8
D60204	2" FIP	4" PB cast round	1/8
D60205	2" no hub	4" CP cast round	1/8
D60206	2" no hub	4" PB cast round	1/8
D60211	2" inside caulk	6" CP cast round	1/1
D60212	2" inside caulk	6" PB cast round	1/1
D60207	2" FIP	6" CP cast round	1/1
D60208	2" FIP	6" PB cast round	1/1
D60209	2" no hub	6" CP cast round	1/1
D60210	2" no hub	6" PB cast round	1/1
D60400	2" inside caulk	4" CP cast square	1/1
D60410	2" inside caulk	4" PB cast square	1/1
D60402	2" FIP	4" CP cast square	1/1
D60412	2" FIP	4" PB cast square	1/1
D60403	2" no hub	4" CP cast square	1/1
D60413	2" no hub	4" PB cast square	1/1
D60499	2" inside caulk push on	4" CP cast square	1/1
D60498	2" inside caulk push on	4" PB cast square	1/1
D60101	2" gasket for inside caulk unit	—	1/1

Items marked with the Jones Stephens logo are "You Need It... We Got It" Items.

2" Shower Drain with Brass Threaded Clamping Ring



- Brass spud
- 6-1/2" pan
- Designed for lead pan showers
- Weep holes in clamping ring

PART NO.	SIZE	STRAINER	CTN/MSTR
D61101	2" IPS	4" SS round	1/4
D61102	2" no hub	4" SS round	1/4
D61103	2" inside caulk	4" SS round	1/4
D61201	2" IPS	4" CP cast brass round	1/4
D61202	2" no hub	4" CP cast brass round	1/4
D61203	2" inside caulk	4" CP cast brass round	1/4
D61301	2" IPS	6" PB cast brass round	1/4
D61302	2" no hub	6" PB cast brass round	1/4
D61303	2" inside caulk	6" PB cast brass round	1/4
D61850	Brass screw-down clamping ring	—	1/1

2" Shower Drain Base with Clamping Ring and Bolts



- 6-1/2" pan; 2-1/2" height
- Tongue and groove cast iron bolt down clamping ring
- Weep holes on both top and bottom for secondary drainage
- Inside caulk unit can be used with gasket to make unit no caulk
- For 2" IPS threaded tailpieces

PART NO.	SIZE	HEIGHT	CTN/MSTR
D60900	2" inside caulk	2-1/2"	1/1
D60901	2" FIP	2-1/2"	1/1
D60902	2" no hub	2-1/2"	1/1

2" Shower Drain Base with Brass Threaded Clamping Ring



- 6-3/8" pan; 3-1/4" height
- Designed for lead pan showers
- Weep holes in clamping ring
- For 2" IPS threaded tailpieces

PART NO.	SIZE	CTN/MSTR
D61800	2" FIP	1/1
D61801	2" no hub	1/1
D61802	2" inside caulk	1/1

F

Cast Iron Commercial Drains

Pages 250-254

F

SIZES: 2", 3", 4"



For use in
commercial applications.

2" Code Blue No Caulk (Mechanical Joint) Floor Drain



- 1/2" Primer tapped with brass plug
- Supplied with stainless steel bolts
- UPC listed

PART NO.	PAN	STRAINER	HEIGHT	CTN/MSTR
D65661	7"	4" NB round	4" - 4-13/16"	1/1
D65662	7"	4" PB round	4" - 4-13/16"	1/1
D66681	9"	4" NB round	4" - 4-13/16"	1/1
D66682	9"	4" PB round	4" - 4-13/16"	1/1
D65500	7"	5" NB round	4" - 5"	1/1
D65501	7"	5" PB round	4" - 5"	1/1
D65502	7"	5" CP round	4" - 5"	1/1
D66500	9"	5" NB round	4" - 5"	1/1
D66501	9"	5" PB round	4" - 5"	1/1
D66502	9"	5" CP round	4" - 5"	1/1
D65503	7"	6" NB round	4-1/4" - 5-1/4"	1/1
D65504	7"	6" PB round	4-1/4" - 5-1/4"	1/1
D65505	7"	6" CP round	4-1/4" - 5-1/4"	1/1
D66503	9"	6" NB round	4-1/4" - 5-1/4"	1/1
D66504	9"	6" PB round	4-1/4" - 5-1/4"	1/1
D66505	9"	6" CP round	4-1/4" - 5-1/4"	1/1
D65509	7"	5" NB square	4-1/4" - 5-1/4"	1/1
D65511	7"	5" PB square	4-1/4" - 5-1/4"	1/1
D66509	9"	5" NB square	4-1/4" - 5-1/4"	1/1
D66511	9"	5" PB square	4-1/4" - 5-1/4"	1/1
D65510	7"	6" NB square	4-1/4" - 5-1/4"	1/1
D65512	7"	6" PB square	4-1/4" - 5-1/4"	1/1
D66510	9"	6" NB square	4-1/4" - 5-1/4"	1/1
D66512	9"	6" PB square	4-1/4" - 5-1/4"	1/1

2" Code Blue (Mechanical Joint) No Caulk Slab Drain



- No clamping ring

PART NO.	PAN	STRAINER	HEIGHT	CTN/MSTR
D67001	7"	4" NB round	3-3/4" - 4-3/4"	1/1
D67002	7"	4" PB round	3-3/4" - 4-3/4"	1/1
D67003	7"	5" NB round	3-3/4" - 4-7/8"	1/1
D67004	7"	5" PB round	4" - 5-3/8"	1/1
D67005	7"	5" CP round	3-1/2" - 4-7/8"	1/1
D67006	7"	6" NB round	3-3/4" - 5-1/8"	1/1
D67007	7"	6" PB round	3-3/4" - 5-1/8"	1/1
D67008	7"	6" CP round	4" - 5-1/2"	1/1

2" Code Blue No Hub Floor Drain



- 1/2" Primer tapped with brass plug
- Supplied with stainless steel bolts
- UPC listed

3 1/2" IPS Spud with 4", 5" or 6" Round Strainer

PART NO.	PAN	STRAINER	HEIGHT	CTN/MSTR
D66675	9"	4" NB round	3-3/4" - 4-5/8"	1/1
D66676	9"	4" PB round	3-3/4" - 4-5/8"	1/1
D65655	7"	4" NB round	3-3/4" - 4-7/16"	1/1
D65656	7"	4" PB round	3-3/4" - 4-7/16"	1/1
D65560	7"	5" NB round	2-7/8" - 4-1/2"	1/1
D65561	7"	5" PB round	2-7/8" - 4-1/2"	1/1
D65562	7"	5" CP round	2-7/8" - 4-1/2"	1/1
D66560	9"	5" NB round	3-1/2" - 5-1/8"	1/1
D66561	9"	5" PB round	3-1/2" - 5-1/8"	1/1
D66562	9"	5" CP round	3-1/2" - 5-1/8"	1/1
D65563	7"	6" NB round	4" - 5-1/4"	1/1
D65564	7"	6" PB round	4" - 5-1/4"	1/1
D65565	7"	6" CP round	4" - 5-1/4"	1/1
D66563	9"	6" NB round	3-5/8" - 5-5/8"	1/1
D66564	9"	6" PB round	3-5/8" - 5-5/8"	1/1
D66565	9"	6" CP round	3-5/8" - 5-5/8"	1/1
D65569	7"	5" NB square	3-1/4" - 5-1/4"	1/1
D65571	7"	5" PB square	3-1/4" - 5-1/4"	1/1
D66569	9"	5" NB square	3-7/8" - 5-7/8"	1/1
D66571	9"	5" PB square	3-7/8" - 5-7/8"	1/1
D65570	7"	6" NB square	4" - 5-1/4"	1/1
D65572	7"	6" PB square	4" - 5-1/4"	1/1
D66570	9"	6" NB square	4-1/8" - 6-3/8"	1/1
D66572	9"	6" PB square	4-1/8" - 6-3/8"	1/1

2" Code Blue No Hub Slab Drain



- No clamping ring

PART NO.	PAN	STRAINER	HEIGHT	CTN/MSTR
D67016	7"	4" NB round	3-5/8" - 4-3/4"	1/1
D67017	7"	4" PB round	3-5/8" - 4-3/4"	1/1
D67018	7"	5" NB round	3-1/2" - 4-7/8"	1/1
D67019	7"	5" PB round	4" - 5-3/8"	1/1
D67020	7"	5" CP round	3-1/2" - 4-7/8"	1/1
D67021	7"	6" NB round	3-7/8" - 5"	1/1
D67022	7"	6" PB round	3-3/4" - 5"	1/1
D67023	7"	6" CP round	4" - 5-3/8"	1/1
D67027	7"	5" NB square	3-3/4" - 5-1/8"	1/1
D67028	7"	5" PB square	3-3/4" - 5-1/8"	1/1
D67029	7"	6" NB square	4" - 5-3/16"	1/1
D67030	7"	6" PB square	4" - 5-3/16"	1/1

2" Code Blue IPS Floor Drain



- 1/2" Primer tapped with brass plug
- Supplied with stainless steel bolts
- UPC listed

PART NO.	PAN	STRAINER	HEIGHT	CTN/MSTR
D66687	9"	4" NB round	3-1/4" - 4"	1/1
D66688	9"	4" PB round	3-1/4" - 4"	1/1
D65665	7"	4" NB round	3-3/16" - 4-3/16"	1/1
D65620	7"	5" NB round	2-7/8" - 4-1/2"	1/1
D65621	7"	5" PB round	2-7/8" - 4-1/2"	1/1
D65622	7"	5" CP round	2-7/8" - 4-1/2"	1/1
D66620	9"	5" NB round	3-1/2" - 5-1/8"	1/1
D66621	9"	5" PB round	3-1/2" - 5-1/8"	1/1
D66622	9"	5" CP round	3-1/2" - 5-1/8"	1/1
D65623	7"	6" NB round	3-1/2" - 4-1/2"	1/1
D65624	7"	6" PB round	3-1/2" - 4-1/2"	1/1
D65625	7"	6" CP round	3-1/2" - 4-1/2"	1/1
D66623	9"	6" NB round	3-5/8" - 5-5/8"	1/1
D66624	9"	6" PB round	3-5/8" - 5-5/8"	1/1
D66625	9"	6" CP round	3-5/8" - 5-5/8"	1/1

2" Code Blue Push-On Floor Drain



- With clamping ring
- Supplied with V96002 gasket for 2" cast iron pipe

PART NO.	PAN	STRAINER	HEIGHT	CTN/MSTR
D66700	9"	4" NB round	4-5/8" - 5-1/2"	1/1
D66701	9"	4" PB round	4-5/8" - 5-1/2"	1/1
D66702	9"	5" NB round	4-5/8" - 5-1/2"	1/1
D66703	9"	5" PB round	5-3/16" - 6-1/8"	1/1
D66704	9"	5" CP round	4-3/4" - 5-1/2"	1/1
D66705	9"	6" NB round	4-7/8" - 5-3/4"	1/1
D66706	9"	6" PB round	4-7/8" - 5-3/4"	1/1
D66707	9"	6" CP round	5-1/4" - 6-1/4"	1/1

2" Bronze Shower Drain



- Heavy bronze body
- Suitable for residential and commercial installation
- 4-1/2" strainers in stainless steel or PVD polished brass
- Solid bronze strainer spuds in standard (1-1/2") or long pattern (2-1/2") length
- 3 types of 2" connections

2" IPS Drain

PART NO.	SPUD	STRAINER	CTN/MSTR
D68510	Standard	4-1/2" SS round	1/1
D68511	Standard	4-1/2" PB (PVD) round	1/1
D68512	Long pattern	4-1/2" SS round	1/1
D68513	Long pattern	4-1/2" PB (PVD) round	1/1

2" Sweat Drain

PART NO.	SPUD	STRAINER	CTN/MSTR
D68710	Standard	4-1/2" SS round	1/1
D68711	Standard	4-1/2" PB (PVD) round	1/1
D68712	Long pattern	4-1/2" SS round	1/1
D68713	Long pattern	4-1/2" PB (PVD) round	1/1

F Replacement Strainers

PART NO.	DESCRIPTION	CTN/MSTR
D68507	4 1/2" SS strainer with screws	100/400
D68508	4 1/2" (PVD) PB strainer with screws	100/400

3" Heavy Duty No Hub Floor/Shower Drain



- Cast metal strainer and tailpiece
- Cast iron body

PART NO.	PAN	STRAINER	HEIGHT	CTN/MSTR
D80200	10"	5" CP round	4-1/2"- 6-1/2"	1/1
D80201	10"	5" PB round	4-1/2"- 6-1/2"	1/1
D80212	10"	5" NB round	4-1/2"- 6-1/2"	1/1
D80202	10"	6" CP round	4-1/2"- 6-1/2"	1/1
D80203	10"	6" PB round	4-1/2"- 6-1/2"	1/1
D80213	10"	6" NB round	4-1/2"- 6-1/2"	1/1
D80214	10"	5" PB square	4-1/2"- 6-1/2"	1/1
D80216	10"	5" NB square	4-1/2"- 6-1/2"	1/1
D80215	10"	6" PB square	4-1/2"- 6-1/2"	1/1
D80217	10"	6" NB square	4-1/2"- 6-1/2"	1/1

3" Heavy Duty Inside Caulk Floor/Shower Drain



- Cast metal strainer and tailpiece
- Cast iron body

PART NO.	PAN	STRAINER	HEIGHT	CTN/MSTR
D80100	10"	5" CP round	4-1/2"- 6-1/2"	1/1
D80101	10"	5" PB round	4-1/2"- 6-1/2"	1/1
D80112	10"	5" NB round	4-1/2"- 6-1/2"	1/1
D80102	10"	6" CP round	4-3/4"- 6-3/4"	1/1
D80103	10"	6" PB round	4-3/4"- 6-3/4"	1/1
D80113	10"	6" NB round	4-3/4"- 6-3/4"	1/1

3" Code Blue No Caulk (Mechanical Joint) Floor Drain



- 1/2" Primer tapped with brass plug
- Supplied with stainless steel bolts
- UPC listed

PART NO.	PAN	STRAINER	HEIGHT	CTN/MSTR
D66683	9"	4" NB round	4"- 4-3/4"	1/1
D66684	9"	4" PB round	4"- 4-3/4"	1/1
D65663	7"	4" NB round	4"- 4-13/16"	1/1
D65664	7"	4" PB round	4"- 4-13/16"	1/1
D65520	7"	5" NB round	2-7/8"- 4-1/2"	1/1
D65521	7"	5" PB round	2-7/8"- 4-1/2"	1/1
D65522	7"	5" CP round	2-7/8"- 4-1/2"	1/1
D66520	9"	5" NB round	3-1/2"- 5-1/8"	1/1
D66521	9"	5" PB round	3-1/2"- 5-1/8"	1/1
D66522	9"	5" CP round	3-1/2"- 5-1/8"	1/1
D65523	7"	6" NB round	3"- 5"	1/1
D65524	7"	6" PB round	3"- 5"	1/1
D65525	7"	6" CP round	3"- 5"	1/1
D66523	9"	6" NB round	3-5/8"- 5-5/8"	1/1
D66524	9"	6" PB round	3-5/8"- 5-5/8"	1/1
D66525	9"	6" CP round	3-5/8"- 5-5/8"	1/1

3" Code Blue No Hub Slab Drain



- No clamping ring

PART NO.	PAN	STRAINER	HEIGHT	CTN/MSTR
D67031	7"	4" NB round	3-1/2"- 4-3/4"	1/1
D67032	7"	4" PB round	3-1/2"- 4-3/4"	1/1
D67033	7"	5" NB round	3-1/2"- 4-13/16"	1/1
D67034	7"	5" PB round	4"- 5-5/16"	1/1
D67035	7"	5" CP round	3-1/2"- 4-13/16"	1/1
D67036	7"	6" NB round	3-3/4"- 5"	1/1
D67037	7"	6" PB round	3-3/4"- 5"	1/1
D67038	7"	6" CP round	4"- 5-3/8"	1/1
D67039	7"	8" NB round	4-1/8"- 5-5/8"	1/1
D67040	7"	8" PB round	4-1/8"- 5-5/8"	1/1
D67042	7"	9" NB round	4-1/4"- 5-5/8"	1/1
D67043	7"	9" PB round	4-1/4"- 5-5/8"	1/1
D67044	7"	5" NB square	3-3/4"- 5-1/16"	1/1
D67045	7"	5" PB square	3-7/8"- 5-1/16"	1/1
D67046	7"	6" NB square	4"- 5-1/4"	1/1
D67047	7"	6" PB square	4"- 5-1/4"	1/1

3" Code Blue No Hub Floor Drain



- 1/2" Primer tapped with brass plug
- Supplied with stainless steel bolts
- UPC listed



PART NO.	PAN	STRAINER	HEIGHT	CTN/MSTR
D65657	7"	4" NB round	3-3/4"- 4-7/16"	1/1
D65658	7"	4" PB round	3-3/4"- 4-7/16"	1/1
D66677	9"	4" NB round	3-3/4"- 4-5/8"	1/1
D66678	9"	4" PB round	3-3/4"- 4-5/8"	1/1
D65580	7"	5" NB round	2-7/8"- 4-1/2"	1/1
D65581	7"	5" PB round	2-7/8"- 4-1/2"	1/1
D65582	7"	5" CP round	2-7/8"- 4-1/2"	1/1
D66580	9"	5" NB round	3-1/2"- 5-1/8"	1/1
D66581	9"	5" PB round	3-1/2"- 5-1/8"	1/1
D66582	9"	5" CP round	3-1/2"- 5-1/8"	1/1
D65583	7"	6" NB round	3"- 5"	1/1
D65584	7"	6" PB round	3"- 5"	1/1
D65585	7"	6" CP round	3"- 5"	1/1
D66583	9"	6" NB round	3-5/8"- 5-5/8"	1/1
D66584	9"	6" PB round	3-5/8"- 5-5/8"	1/1
D66585	9"	6" CP round	3-5/8"- 5-5/8"	1/1

Items marked with the Jones Stephens logo are "You Need It...We Got It" Items.

3" Code Blue IPS Floor Drain



- 1/2" Primer tapped with brass plug
- Supplied with stainless steel bolts
- UPC listed



PART NO.	PAN	STRAINER	HEIGHT	CTN/MSTR
D66689	9"	4" NB round	3-1/4" x 4"	1/1
D66690	9"	4" PB round	3-1/4" x 4"	1/1
D65667	7"	4" NB round	3-3/16"- 4-13/16"	1/1
D65668	7"	4" PB round	3-3/16"- 4-13/16"	1/1
D65640	7"	5" NB round	2-7/8"- 4-1/2"	1/1
D65641	7"	5" PB round	2-7/8"- 4-1/2"	1/1
D65642	7"	5" CP round	2-7/8"- 4-1/2"	1/1
D66640	9"	5" NB round	3-1/2"- 5-1/8"	1/1
D66641	9"	5" PB round	3-1/2"- 5-1/8"	1/1
D66642	9"	5" CP round	3-1/2"- 5-1/8"	1/1
D65643	7"	6" NB round	3"- 5"	1/1
D65644	7"	6" PB round	3"- 5"	1/1
D65645	7"	6" CP round	3"- 5"	1/1
D66643	9"	6" NB round	3-5/8"- 5-5/8"	1/1
D66644	9"	6" PB round	3-5/8"- 5-5/8"	1/1
D66645	9"	6" CP round	3-5/8"- 5-5/8"	1/1

4" Heavy Duty No Hub Floor/Shower Drain



- Cast metal strainer and tailpiece
- Cast iron body

PART NO.	PAN	STRAINER	HEIGHT	CTN/MSTR
D80206	10"	5" CP round	4-1/2"- 6-1/2"	1/1
D80207	10"	5" PB round	4-1/2"- 6-1/2"	1/1
D80218	10"	5" NB round	4-1/2"- 6-1/2"	1/1
D80209	10"	6" PB round	4-3/4"- 6-3/4"	1/1
D80219	10"	6" NB round	4-3/4"- 6-3/4"	1/1
D80211	10"	8" PB round	5"- 7"	1/1
D80220	10"	5" PB square	4-1/2"- 6-1/2"	1/1
D80222	10"	5" NB square	4-1/2"- 6-1/2"	1/1
D80221	10"	6" PB square	4-3/4"- 6-3/4"	1/1
D80223	10"	6" NB square	4-3/4"- 6-3/4"	1/1

4" Heavy Duty Inside Caulk Floor/Shower Drain



- Cast metal strainer and tailpiece
- Cast iron body

PART NO.	PAN	STRAINER	HEIGHT	CTN/MSTR
D80106	10"	5" CP round	4-1/2"- 6-1/2"	1/1
D80107	10"	5" PB round	4-1/2"- 6-1/2"	1/1
D80118	10"	5" NB round	4-1/2"- 6-1/2"	1/1
D80108	10"	6" CP round	4-3/4"- 6-3/4"	1/1
D80109	10"	6" PB round	4-3/4"- 6-3/4"	1/1
D80119	10"	6" NB round	4-3/4"- 6-3/4"	1/1

4" Code Blue No Caulk (Mechanical Joint) Floor Drain



- 1/2" Primer tapped with brass plug
- Supplied with stainless steel bolts
- UPC listed



PART NO.	PAN	STRAINER	HEIGHT	CTN/MSTR
D66685	9"	4" NB round	4" - 4-7/8"	1/1
D66686	9"	4" PB round	4" - 4-7/8"	1/1
D66540	9"	5" NB round	3-1/2"- 5-1/8"	1/1
D66541	9"	5" PB round	3-1/2"- 5-1/8"	1/1
D66542	9"	5" CP round	3-1/2"- 5-1/8"	1/1
D66543	9"	6" NB round	3-5/8"- 5-5/8"	1/1
D66544	9"	6" PB round	3-5/8"- 5-5/8"	1/1
D66545	9"	6" CP round	3-5/8"- 5-5/8"	1/1

4" Code Blue No Hub Slab Drain



- No clamping ring

PART NO.	PAN	STRAINER	HEIGHT	CTN/MSTR
D67048	7"	4" NB round	3-5/8"- 4-7/8"	1/1
D67049	7"	4" PB round	3-5/8"- 4-7/8"	1/1
D67050	7"	5" NB round	3-5/8"- 4-7/8"	1/1
D67051	7"	5" PB round	4" - 5-3/8"	1/1
D67052	7"	5" CP round	3-1/2"- 4-7/8"	1/1
D67053	7"	6" NB round	3-7/8"- 5-1/16"	1/1
D67054	7"	6" PB round	3-3/4"- 5-1/16"	1/1
D67055	7"	6" CP round	4" - 5-1/2"	1/1

4" Code Blue IPS Floor Drain



- 1/2" Primer tapped with brass plug
- Supplied with stainless steel bolts
- UPC listed



PART NO.	PAN	STRAINER	HEIGHT	CTN/MSTR
D66691	9"	4" NB round	3-1/4" - 4"	1/1
D66692	9"	4" PB round	3-1/4" - 4"	1/1
D66660	9"	5" NB round	3-1/2"- 5 1/8"	1/1
D66661	9"	5" PB round	3-1/2"- 5-1/8"	1/1
D66662	9"	5" CP round	3-1/2"- 5-1/8"	1/1
D66663	9"	6" NB round	3-5/8"- 5-5/8"	1/1
D66664	9"	6" PB round	3-5/8"- 5-5/8"	1/1
D66665	9"	6" CP round	3-5/8"- 5-5/8"	1/1

4" Code Blue Push-On Floor Drain



- With clamping ring
- Supplied with V96004 gasket for 4" cast iron pipe

PART NO.	PAN	STRAINER	HEIGHT	CTN/MSTR
D66732	9"	4" NB round	4-3/4"- 5-1/2"	1/1
D66733	9"	4" PB round	4-3/4"- 5-1/2"	1/1
D66734	9"	5" NB round	4-3/4"- 5-5/8"	1/1
D66735	9"	5" PB round	5-1/4"- 6-3/16"	1/1
D66736	9"	5" CP round	4-3/4"- 5-5/8"	1/1
D66737	9"	6" NB round	5" - 6-1/8"	1/1
D66738	9"	6" PB round	5" - 6-1/8"	1/1
D66739	9"	6" CP round	5-3/8"- 6-3/8"	1/1

4" Code Blue No Hub Floor Drain



- 1/2" Primer tapped with brass plug
- Supplied with stainless steel bolts
- UPC listed



PART NO.	PAN	STRAINER	HEIGHT	CTN/MSTR
D66679	9"	4" NB round	3-3/8"- 4-5/8"	1/1
D66680	9"	4" PB round	3-3/8"- 4-5/8"	1/1
D65659	7"	4" NB round	3-3/4"- 4-7/16"	1/1
D65660	7"	4" PB round	3-3/4"- 4-7/16"	1/1
D65600	7"	5" NB round	3-1/2"- 4-3/4"	1/1
D65601	7"	5" PB round	3-1/2"- 4-3/4"	1/1
D65602	7"	5" CP round	3-1/2"- 4-3/4"	1/1
D66600	9"	5" NB round	3-1/2"- 4-3/4"	1/1
D66601	9"	5" PB round	3-1/2"- 4-3/4"	1/1
D66602	9"	5" CP round	3-1/2"- 4-3/4"	1/1
D65603	7"	6" NB round	3-3/4"- 5"	1/1
D65604	7"	6" PB round	3-3/4"- 5"	1/1
D65605	7"	6" CP round	3-3/4"- 5"	1/1
D66603	9"	6" NB round	3-3/4"- 5"	1/1
D66604	9"	6" PB round	3-3/4"- 5"	1/1
D66605	9"	6" CP round	3-3/4"- 5"	1/1

Cast Iron Commercial Drain Components

Pages 255-257

SIZES: 2", 3", 3-1/2", 4"



For use in
commercial applications.

Heavy Duty Drain Base



- For use with heavy duty floor drains
- For 3-1/2" IPS threaded tailpieces

PART NO.	SIZE	PAN	HEIGHT	CTN/MSTR
D80097	3" no hub	10-1/2"	3-1/2"	1/1
D80099	3" inside caulk	10-1/2"	3-1/2"	1/1
D80090	3" no hub; 1/2 PT	10-1/2"	3-1/2"	1/1
D80096	4" no hub	10-1/2"	3-1/2"	1/1
D80098	4" inside caulk	10-1/2"	3-1/2"	1/1
D80091	4" no hub; 1/2 PT	10-1/2"	3-1/2"	1/1

Code Blue No Caulk (Mechanical Joint) Drain Base



- 1/2" Primer tapped with brass plug
- Supplied with stainless steel bolts
- Test plug included
- Tapped for 3-1/2" spud



PART NO.	SIZE	PAN	SPUD	HEIGHT	CTN/MSTR
D65002	2"	7"	3-1/2"	2-1/2"	1/1
D66002	2"	9"	3-1/2"	3-1/8"	1/1
D65003	3"	7"	3-1/2"	2-1/2"	1/1
D66003	3"	9"	3-1/2"	3-1/8"	1/1
D66004	4"	9"	3-1/2"	3-1/8"	1/1

Code Blue No Hub Drain Base



- Tapped for 3-1/2" spud
- 1/2" Primer tapped with brass plug
- Supplied with stainless steel bolts



PART NO.	SIZE	PAN	SPUD	HEIGHT	CTN/MSTR
D65102	2"	7"	3-1/2"	2-1/2"	1/1
D66102	2"	9"	3-1/2"	3-1/8"	1/1
D65103	3"	7"	3-1/2"	2-1/2"	1/1
D66103	3"	9"	3-1/2"	3-1/4"	1/1
D65104	4"	7"	3-1/2"	2-1/2"	1/1
D66104	4"	9"	3-1/2"	3-1/8"	1/1

Code Blue IPS Drain Base



- Tapped for 3-1/2" spud
- 1/2" Primer tapped with brass plug
- Supplied with stainless steel bolts



PART NO.	SIZE	PAN	SPUD	HEIGHT	CTN/MSTR
D65202	2" IPS	7"	3-1/2"	2-1/2"	1/1
D66202	2" IPS	9"	3-1/2"	3-1/8"	1/1
D65203	3" IPS	7"	3-1/2"	2-1/2"	1/1
D66203	3" IPS	9"	3-1/2"	3-1/8"	1/1
D66204	4" IPS	9"	3-1/2"	3-1/8"	1/1

Code Blue No Caulk (Mechanical Joint) Slab Drain Base



- 1/2" primer tap with brass plug
- Less clamping ring
- Tapped for 3-1/2" spud

PART NO.	SIZE	PAN	SPUD	HEIGHT	CTN/MSTR
D67201	2"	7"	3-1/2"	3-3/8"	1/1

Code Blue No Hub Slab Drain Base



- 1/2" primer tap with brass plug
- Less clamping ring
- Tapped for 3-1/2" spud

PART NO.	SIZE	PAN	SPUD	HEIGHT	CTN/MSTR
D67200	2"	7"	3-1/2"	3-3/8"	1/1
D67300	3"	7"	3-1/2"	3-3/8"	1/1
D67400	4"	7"	3-1/2"	3-3/8"	1/1

Code Blue Push-On Drain Base

F



- 1/2" primer tapped with brass plug
- Tapped for 3-1/2" spud
- Supplied with stainless steel bolts
- For PVC connections, you must replace with extra heavy Dual Tite gaskets

PART NO.	SIZE	PAN	SPUD	HEIGHT	CTN/MSTR
D66200	2"	9"	3-1/2"	3-3/4"	1/1
D66400	4"	9"	3-1/2"	3-3/4"	1/1

No Hub Base



- Use with CI strainers or covers for heavy trucking traffic
- Use with PB, NB, SS or CP strainers or covers for heavy pedestrian traffic

NOTE: 3" No hub will receive a 2" multi-tite gasket and therefore becomes a 2" push-on body. 4" No hub will receive a 3" multi-tite gasket.

PART NO.	NO HUB BASE x SPUD	HEIGHT	CTN/MSTR
D63300	3"x 3" IPS	4-1/4"	1/1
D63349	3"x 3-1/2" IPS	4-1/4"	1/1
D63350	4"X 3-1/2" IPS	4-1/4"	1/1
D63400	4"x 4" IPS	4-1/4"	1/1

Gasket Connection Base



- Supplied with Multi-Tite gasket
- Use with CI strainers or covers for heavy trucking traffic
- Use with PB, NB, SS or CP strainers or covers for heavy pedestrian traffic

PART NO.	S.V. BASE x SPUD	HEIGHT	CTN/MSTR
D62300	3"x 3" IPS	5-1/4"	1/1
D62349	3"x 3-1/2" IPS	5-1/4"	1/1
D62350	4"x 3-1/2" IPS	5-1/2"	1/1
D62400	4"x 4" IPS	5-1/2"	1/1

3-1/2" Spud Extension



- 2-1/2"-4" extension for a 3-1/2 drain/cleanout spud
- Use on cast iron or PVC drain bodies when additional height is needed to offset inconsistent concrete pours

PART NO.	DESCRIPTION	CTN/MSTR
D60979	3-1/2" spud extension	1/1

Cast Iron Spud with Round Strainer for Heavy Duty Drain Base



- For use with heavy duty floor drains

2-1/2" IPS Threaded Throat for Testing with Round Strainer

PART NO.	SPUD	STRAINER	CTN/MSTR
D62130	3" IPS	4-9/16" CI round	1/1
D62131	3" IPS	5" NB round with ring	1/1
D62132	3" IPS	5" PB round with ring	1/1

3" IPS Threaded Throat for Testing with Round Strainer

PART NO.	SPUD	STRAINER	CTN/MSTR
D62135	3-1/2" IPS	5-1/2" CI round	1/1
D62136	3-1/2" IPS	6" NB round with ring	1/1
D62137	3-1/2" IPS	6" PB round with ring	1/1

3-1/2" IPS Threaded Throat for Testing with Round Strainer

PART NO.	SPUD	STRAINER	CTN/MSTR
D62140	4" IPS	5-1/2" CI round	1/1
D62141	4" IPS	6" NB round with ring	1/1
D62142	4" IPS	6" PB round with ring	1/1

Plastic Spud with Square Top and Round Strainer for Heavy Duty Drain Base



- For use with heavy duty floor drains
- 5" round cover with 7" square top

PART NO.	IPS	STRAINER	CTN/MSTR
D56501	3"	5" NB round with square top	1/1
D56503	3-1/2"	5" NB round with square top	1/1
D56505	4"	5" NB round with square top	1/1

3-1/2" Metal Spud with Round Strainer



• For use with floor drains



PART NO.	IPS	STRAINER	CTN/MSTR
D60986	3-1/2"	4" NB round	1/40
D60987	3-1/2"	4" PB round	1/40
Replacement Strainer			
PART NO.	DESCRIPTION	CTN/MSTR	
D60966	Replacement strainer for D60986	1/50	
D60967	Replacement strainer for D60987	1/100	

3-1/2" Metal Spud with Square Strainer



• For use with floor drains



PART NO.	IPS	STRAINER	SCREWS	CTN/MSTR
D60954	3-1/2"	5" CP square	4 (3-7/8")	1/20
D60960	3-1/2"	5" PB square	4 (3-7/8")	1/20
D60962	3-1/2"	5" NB square	4 (3-7/8")	1/20
D60961	3-1/2"	6" PB square	4 (4-7/8")	1/12
D60963	3-1/2"	6" NB square	4 (4-7/8")	1/12

Metal Spud with Round Strainer



• For use with floor drains



PART NO.	IPS	STRAINER	SCREWS	CTN/MSTR
D60980	2"	4" SS stamped	2 (3-3/8")	1/50
D60981	2"	4" Chrome cast	2 (3-3/8")	1/50
D60982	2"	4" PB cast	2 (3-3/8")	1/50
D60970	2"	6" CP	2 (5")	1/30
D60975	2"	6" PB	2 (5")	1/30
D60955	2"	5" NB	3 (3-7/8")	1/30
D60956	3"	5" PB	3 (3-7/8")	1/30
D60986	3-1/2"	4" NB	2 (3-1/4")	1/40
D60987	3-1/2"	4" PB	2 (3-1/4")	1/40
D60990	3-1/2"	5" CP	3 (3-7/8")	1/40
D60991	3-1/2"	5" PB	3 (3-7/8")	1/40
D60996	3-1/2"	5" NB	3 (3-7/8")	1/30
D60997	3-1/2"	6" NB	3 (4-3/4")	1/20
D60992	3-1/2"	6" CP	2 (5")	1/20
D60993	3-1/2"	6" PB	2 (5")	1/20
D60995	3-1/2"	8" PB	4 (6-3/4")	1/10
D60998	3-1/2"	8" NB	4 (6-3/4")	1/12
D60989	3-1/2"	9" PB	4 (7-5/8")	1/12
D60999	3-1/2"	9" NB	4 (7-5/8")	1/12
D60958	4"	5" NB	3 (3-7/8")	1/30
D60959	4"	5" PB	3 (3-7/8")	1/30

Items marked with the Jones Stephens logo are "You Need It...We Got It" Items.

Funnel



- Vandal-proof installation
- Fits virtually any floor/shower drain
- Funnel tapped for 10-24 screws which are supplied with washers

PART NO.	DESCRIPTION	CTN/MSTR
F65400	4" funnel	1/1
F65600	6" funnel	1/18

The Green Drain Waterless Trap Seal



- Requires NO caulk or expensive installation tool
- Easy to install and easy to remove - NO pliers needed
- Durable - will not break during installation or removal
- Seals tight - NO leaking

PART NO.	DESCRIPTION	CTN/MSTR
P24001	2" waterless trap seal	1/96
P24002	3" waterless trap seal	1/96
P24003	3-1/2" waterless trap seal	1/96
P24004	4" waterless trap seal	1/96

F

Cast Iron General Purpose/Utility Drains

Pages 258-259

F

SIZES: 1-1/2", 2", 3", 4"



For use in residential and commercial applications.

Area Drain



- Full waterway
- Lip secures strainer

DRAIN SPECS

SIZE	TOP WIDTH	OVERALL HEIGHT
2"	4-7/8"	3-1/4"
3"	6-3/16"	3-1/4"
4"	7-3/16"	3-1/4"

STRAINER SPECS

SIZE	A	B
2"	4-1/4"	4-1/4"
3"	5-3/8"	5-5/8"
4"	6-11/16"	6-11/16"

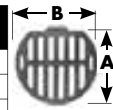

PART NO.	DESCRIPTION	CTN/MSTR
D76002	2" inside caulk drain	1/8
D77002	2" no hub drain	1/8
D76012	2" inside caulk CP area drain with strainer	1/8
D76092	2" strainer only	1/1
D76003	3" inside caulk drain	1/4
D77003	3" no hub drain	1/4
D76013	3" inside caulk CP area drain with strainer	1/4
D76093	3" strainer only	1/1
D76004	4" inside caulk drain	1/4
D77004	4" no hub drain	1/4
D76014	4" inside caulk CP area drain with strainer	1/4
D76094	4" strainer only	1/1

Cast Iron Gasket Connection Drain



- Supplied with Multi-Tite gasket
- Just lube gasket and push over S.V. or N.H. cast iron pipe
- NB and PB covers are for heavy pedestrian traffic areas
- CI covers are for heavy duty traffic

PART NO.	SIZE	STRAINER	CTN/MSTR
D62950	3"	5" NB round with ring	1/1
D62951	3"	5" PB round with ring	1/1
D62952	3"	4" CI round	1/1
D62960	4"	6" NB round with ring	1/1
D62961	4"	6" PB round with ring	1/1
D62962	4"	5" CI round	1/1

Kentucky Drain



- Inside caulk

PART NO.	DESCRIPTION	CTN/MSTR
C73003	3" inside caulk drain	1/4
C73093	3" strainer only	1/1
C73192	3" drain with 2" hole in strainer	1/4
C73193	3" strainer only with 2" hole	1/1
C73004	4" inside caulk drain	1/4
C73094	4" strainer only	1/1

St. Louis Drain



- Heavy duty loose set strainer
- Inside caulk

PART NO.	DESCRIPTION	CTN/MSTR
C72002	2" inside caulk	1/8
C72003	3" inside caulk	1/4
C72004	4" inside caulk	1/2
C72093	6-1/4" OD round strainer	1/1

Inside Caulk Shower Stall Drain



- Designed for prefab shower stalls
- Snap in stainless steel strainer
- Fits 2" Schedule 40 and cast iron pipe
- Can be adapted to no caulk with gasket
- 4-1/4" OD strainer

PART NO.	DESCRIPTION	STRAINER	CTN/MSTR
D40102	2" inside caulk	4" SS round	1/36
D40202	2" inside caulk	4" PB round	1/20
D60101	Gasket to make unit no caulk	—	1/1

IPS Shower Stall Drain



- Designed for prefab shower stalls
- Snap in stainless steel strainer
- 4-1/4" O.D. strainer

PART NO.	SIZE	STRAINER	CTN/MSTR
D40104	1-1/2"	4" SS round	1/36
D40204	1-1/2"	4" PB round	1/20
D40103	2"	4" SS round	1/36
D40203	2"	4" PB round	1/20

FIP Shower Stall Drain



- Cast brass body
- Stainless steel strainer

PART NO.	SIZE	BODY	STRAINER	CTN/MSTR
D40200	2"	Cast brass	SS round	1/100

Brass Inside Caulk Floor Drain



- For use where pan liner is not required
- Brass body

PART NO.	DESCRIPTION	BODY	STRAINER	CTN/MSTR
D76601	2" inside caulk	Brass	SS round	1/50

Urinal Drain



- Brass body with stainless steel strainer

PART NO.	DESCRIPTION	CTN/MSTR
D45002	2" IPS	1/40

Urinal Drain Flange Kit



- Brass
- Kit includes all necessary hardware
- Center-to-center for bolt holes is 4-1/4"

PART NO.	SIZE	CTN/MSTR
F10005	2" IPS x 4-1/4"	1/50

Combination Drain Trap



- Bolt-down clamping collar
- Weep holes and grooves in clamping flange

PART NO.	SIZE	STRAINER	CTN/MSTR
J60060	2" IPS	4" SS round	1/1
J60061	2" IPS	4" CP brass round	1/1
J60062	2" IPS	4" PB round	1/1

Floor Drain with Trap



- Throat of drain is threaded for backwater device D70500

Concealed Cleanout

PART NO.	DESCRIPTION	CTN/MSTR
D70001	2" drain	1/1
D70011	2" drain with backwater device	1/1
D70098	6-3/8" cast iron strainer	1/1

Exposed Cleanout

D70020	2" drain with backwater device	1/1
D70022	2" drain with 1/2" PT	1/1
D71103	3" drain - backwater device not compatible	1/1
D70021	2" drain with backwater device	1/1

Des Moines Pattern Floor Drain



- Bolt down lid
- Integral trap

PART NO.	DESCRIPTION	CTN/MSTR
D71003	3" with trap	1/1
D71004	Strainer for Des Moines (screws not included)	1/1

Backwater Device



- Sleeve type
- Ball included

PART NO.	DESCRIPTION	CTN/MSTR
D70500	2" MIP brass body	1/50
B06001	2" MIP plastic body	1/50
B70499	2" plastic ball	1/1300

Cast Iron Commercial Cleanouts

Pages 260-263

F

SIZES: 2", 3", 4", 6"



For use in applications
where height adjustments
are necessary.

Push-On Cleanout



- Meets ASTM A74-98 and ASME A112.36.2M-91
- Cut pipe to desired level, lube gasket and push-on pipe, tap with lead hammer to seat, then install plug
- Schedule 40 unit fits plastic and extra heavy cast iron pipe

Less Gasket

PART NO.	PIPE SIZE	PLUG	HEIGHT	CTN/MSTR
C36003	3" SV	2-1/2" raised head	3"	1/8
C36013	3" SV	2-1/2" countersunk	3"	1/8
C36004	4" SV	3-1/2" raised head	3"	1/8
C36014	4" SV	3-1/2" countersunk	3"	1/8
C36024	4" Sch.40	3-1/2" raised head	3"	1/8
C36034	4" Sch.40	3-1/2" countersunk	3"	1/8
C36006	6" SV	4" raised head	2-3/4"	1/4
C36016	6" SV	4" countersunk	2-3/4"	1/4

With Gasket

PART NO.	PIPE SIZE	PLUG	HEIGHT	CTN/MSTR
C36104	4" SV	3-1/2" raised head	3-1/4"	1/8
C36114	4" SV	3-1/2" countersunk	3-1/4"	1/8
C36124	4" Sch.40	3-1/2" raised head	3-1/4"	1/8
C36134	4" Sch.40	3-1/2" countersunk	3-1/4"	1/8
C36106	6" SV	4" raised head	3"	1/4
C36116	6" SV	4" countersunk	3"	1/4

No Hub Cleanout with Plug



Southern Code Plug

PART NO.	PIPE SIZE	PLUG	HEIGHT	CTN/MSTR
C38402	2"	1-1/2" raised head	2-1/8"	1/10
C39402	2"	1-1/2" countersunk	2-1/8"	1/10
C38403	3"	2-1/2" raised head	2-1/8"	1/10
C39403	3"	2-1/2" countersunk	2-1/8"	1/10
C38404	4"	3-1/2" raised head	2-1/8"	1/10
C39404	4"	3-1/2" countersunk	2-1/8"	1/10

Heavy Plug

PART NO.	PIPE SIZE	PLUG	HEIGHT	CTN/MSTR
C38502	2"	1-1/2" raised head	2-1/8"	1/10
C39502	2"	1-1/2" countersunk	2-1/8"	1/10
C38503	3"	2-1/2" raised head	2-1/8"	1/10
C39503	3"	2-1/2" countersunk	2-1/8"	1/10
C38504	4"	3-1/2" raised head	2-1/8"	1/10
C39504	4"	3-1/2" countersunk	2-1/8"	1/10

New Orleans Code Plug

PART NO.	PIPE SIZE	PLUG	HEIGHT	CTN/MSTR
C40102	2"	1-1/2" plug	2-1/4"	1/10
C40103	3"	2-1/2" plug	2-1/4"	1/10
C40104	4"	3-1/2" plug	2-1/4"	1/10

Plain End Cast Iron Cleanout Short Pattern with Southern Code Plug



• Fits flush with hub

PART NO.	PIPE SIZE	PLUG	HEIGHT	CTN/MSTR
C38102	2"	1-1/2" raised head	2-7/8"	1/10
C39102	2"	1-1/2" countersunk	2-7/8"	1/10
C38103	3"	2-1/2" raised head	3-5/8"	1/10
C39103	3"	2-1/2" countersunk	3-5/8"	1/10
C38104	4"	3" raised head	3"	1/10
C39104	4"	3" countersunk	3"	1/10
C38114	4"	3-1/2" raised head	3"	1/10
C39114	4"	3-1/2" countersunk	3"	1/10

Plain End Cleanout Long Pattern



• For use with service weight (caulk into hub) or no-hub (use coupling)

With Southern Code Plug

PART NO.	PIPE SIZE	PLUG	HEIGHT	CTN/MSTR
C38002	2"	1-1/2" raised head (low sq.)	3-1/4"	1/12
C39002	2"	1-1/2" countersunk	3-1/4"	1/12
C38003	3"	2-1/2" raised head (low sq.)	4"	1/12
C39003	3"	2-1/2" countersunk	4"	1/12
C38004	4"	3" raised head (low sq.)	4"	1/8
C39004	4"	3" countersunk	4"	1/8
C38014	4"	3-1/2" raised head (low sq.)	4"	1/8
C39014	4"	3-1/2" countersunk	4"	1/8
C38005	5"	4" raised head (low sq.)	3-1/2"	1/4
C39005	5"	4" countersunk	3-1/2"	1/4
C38006	6"	5" raised head (low sq.)	4"	1/2
C39006	6"	5" countersunk	4"	1/2

With Heavy Pattern Plug

PART NO.	PIPE SIZE	PLUG	HEIGHT	CTN/MSTR
C38202	2"	1-1/2" raised head (hex)	3-1/4"	1/12
C39202	2"	1-1/2" countersunk	3-1/4"	1/12
C38203	3"	2-1/2" raised head (hex)	4"	1/12
C39203	3"	2-1/2" countersunk	4"	1/12
C38204	4"	3" raised head (hex)	4"	1/8
C39204	4"	3" countersunk	4"	1/8
C38214	4"	3-1/2" raised head (hex)	4"	1/8
C39214	4"	3-1/2" countersunk	4"	1/8
C38205	5"	4" raised head (hex)	3-1/2"	1/4
C39205	5"	4" countersunk	3-1/2"	1/4
C38206	6"	5" raised head (hex)	4"	1/2
C39206	6"	5" countersunk	4"	1/2

Cleanout Ferrule with New Orleans Code Plug



• Service weight

PART NO.	PIPE SIZE	PLUG	HEIGHT	CTN/MSTR
C40002	2" SV	1-1/2"	3"	1/12
C40003	3" SV	2-1/2"	4"	1/12
C40004	4" SV	3 1/2"	4"	1/8
C40006	6" SV	5"	4"	1/2

Plumb Lock Adjustable Cleanout



• Supplied with Multi-Tite gasket
• Similar to Zurn Neo-Loc line

3" Spud with 3" Gasket Connection

PART NO.	PIPE SIZE	COVER	BODY HEIGHT	ADJ. HEIGHT	CTN/MSTR
D62330	3"	5" CI round	5-1/4"	5-7/8" - 7"	1/1
D62333	3"	5" NB round	5-1/4"	5-7/8" - 7"	1/1
D62334	3"	5" PB round	5-1/4"	5-7/8" - 7"	1/1
D62335	3"	5" CP round	5-1/4"	5-7/8" - 7"	1/1

4" Spud with 4" Gasket Connection

PART NO.	PIPE SIZE	COVER	BODY HEIGHT	ADJ. HEIGHT	CTN/MSTR
D62433	4"	5" NB round	5-1/2"	6-1/8" - 7-1/4"	1/1
D62434	4"	5" PB round	5-1/2"	6-1/8" - 7-1/4"	1/1
D62443	4"	5" NB round w/4" plug	5-1/2"	6-1/8" - 7-1/4"	1/1
D62444	4"	5" PB round w/4" plug	5-1/2"	6-1/8" - 7-1/4"	1/1

4" Spud with 6" Gasket Connection

PART NO.	PIPE SIZE	COVER	BODY HEIGHT	ADJ. HEIGHT	CTN/MSTR
D62601	6"	5" NB round	3-1/4"	3-5/8" - 4-3/4"	1/1
D62602	6"	5" PB round	3-1/4"	3-5/8" - 4-3/4"	1/1

No Hub Adjustable Cleanout



- CI cover is for forklift or heavy trucking traffic
- NB and PB covers are for heavy pedestrian traffic

3" Spud					
PART NO.	PIPE SIZE	COVER	BODY HEIGHT	ADJ. HEIGHT	CTN/MSTR
D63330	3"	5" CI round	4-1/4"	4-7/8" - 6"	1/1
D63333	3"	5" NB round	4-1/4"	4-7/8" - 6"	1/1
D63334	3"	5" PB round	4-1/4"	4-7/8" - 6"	1/1
D63335	3"	5" CP round	4-1/4"	4-7/8"-6"	1/1

4" Spud					
PART NO.	PIPE SIZE	COVER	BODY HEIGHT	ADJ. HEIGHT	CTN/MSTR
D63433	4"	5" NB round	4-1/4"	4-7/8"- 6"	1/1
D63434	4"	5" PB round	4-1/4"	4-7/8"- 6"	1/1

Adjustable Plain End Cleanout

F



- CI cover is for forklift or heavy trucking traffic
- NB and PB covers are for heavy pedestrian traffic
- Cleanout body with brass plug
- Can also be caulked into hub

PART NO.	PIPE SIZE	COVER	ADJ. HEIGHT	CTN/MSTR
C33021	2"	5-1/4" CI round with center screw	3-1/8"- 4-1/4"	1/1
C33022	2"	5-1/2" NB round with ring	3"- 4-3/4"	1/1
C33023	2"	5-1/2" PB round with ring	3"- 4-3/4"	1/1
C33031	3"	5-1/4" CI round with center screw	4"- 5-3/4"	1/1
C33032	3"	5-1/2" NB round with ring	4-1/4" - 6"	1/1
C33033	3"	5-1/2" PB round with ring	4-1/4" - 6"	1/1
C33044	4"	6-3/16" CI with center screw	5-1/8"- 6-1/8"	1/1
C33045	4"	6-1/2" NB round with ring	5-3/8"- 6-3/8"	1/1
C33046	4"	6-1/2" PB round with ring	5-3/8"- 6-3/8"	1/1

Adjustable Push-On Cleanout for Cast Iron Pipe



- Supplied with gasket for cast iron pipe
- CI cover is for forklift or heavy trucking traffic
- NB and PB covers are for heavy pedestrian traffic
- Cleanout body with brass plug

PART NO.	PIPE SIZE	COVER	ADJ. HEIGHT	CTN/MSTR
C33121	3"	5-1/4" CI round with center screw	3-7/8"- 4-3/4"	1/1
C33122	3"	5-1/2" NB round with ring	4-1/8"- 5"	1/1
C33123	3"	5-1/2" PB round with ring	4-1/8"- 5"	1/1
C33144	4"	6-3/16" CI round with center screw	4-7/8"- 5-3/4"	1/1
C33145	4"	6-1/2" NB round with ring	5"- 6"	1/1
C33146	4"	6-1/2" PB round with ring	5"- 6"	1/1

Adjustable Cleanout for Plastic Pipe



- CI cover is for forklift or heavy trucking traffic
- NB and PB covers are for heavy pedestrian traffic
- Cleanout body with plastic plug

PART NO.	HEIGHT ADJUSTMENT	PART NO.	HEIGHT ADJUSTMENT
C33221	2-7/8" - 3-7/8"	C33321	2-7/8" - 3-7/8"
C33222	3-1/8" - 4-1/8"	C33322	3-1/8" - 4-1/8"
C33223	3-1/8" - 4-1/8"	C33323	3-1/8" - 4-1/8"
C33231	4" - 5"	C33331	4" - 5"
C33232	4-1/4" - 5-1/4"	C33332	4-1/4" - 5-1/4"
C33233	4-1/4" - 5-1/4"	C33333	4-1/4" - 5-1/4"
C33244	5-1/8" - 6-1/4"	C33344	5-1/8" - 6-1/4"
C33245	5-3/8" - 6-1/2"	C33345	5-3/8" - 6-1/2"
C33246	5-3/8" - 6-1/2"	C33346	5-3/8" - 6-1/2"

PART NO.	SIZE	COVER	MATERIAL	CTN/MSTR
C33221	2"	5-1/4" CI round with center screw	PVC	1/1
C33321	2"	5-1/4" CI round with center screw	ABS	1/1
C33222	2"	5-1/2" NB round with ring	PVC	1/1
C33322	2"	5-1/2" NB round with ring	ABS	1/1
C33223	2"	5-1/2" PB round with ring	PVC	1/1
C33323	2"	5-1/2" PB round with ring	ABS	1/1
C33231	3"	5-1/4" CI round with center screw	PVC	1/1
C33331	3"	5-1/4" CI round with center screw	ABS	1/1
C33232	3"	5-1/2" NB round with ring	PVC	1/1
C33332	3"	5-1/2" NB round with ring	ABS	1/1
C33233	3"	5-1/2" PB round with ring	PVC	1/1
C33333	3"	5-1/2" PB round with ring	ABS	1/1
C33244	4"	6-3/16" CI round with center screw	PVC	1/1
C33344	4"	6-3/16" CI round with center screw	ABS	1/1
C33245	4"	6-1/2" NB round with ring	PVC	1/1
C33345	4"	6-1/2" NB round with ring	ABS	1/1
C33246	4"	6-1/2" PB round with ring	PVC	1/1
C33346	4"	6-1/2" PB round with ring	ABS	1/1

Adjustable Cleanout for Plastic Pipe Hub



- CI cover is for forklift or heavy trucking traffic
- NB and PB covers are for heavy pedestrian traffic
- Cleanout body with plastic plug

PART NO.	HEIGHT ADJUSTMENT	PART NO.	HEIGHT ADJUSTMENT
C33444	3" - 4-1/2"	C33544	3" - 4-1/2"
C33445	3-1/4" - 4-3/4"	C33545	3-1/4" - 4-3/4"
C33446	3-1/4" - 4-3/4"	C33546	3-1/4" - 4-3/4"

PART NO.	SIZE	COVER	MATERIAL	CTN/MSTR
C33444	4"	6-3/16" CI round with center screw	PVC	1/1
C33544	4"	6-3/16" CI round with center screw	ABS	1/1
C33445	4"	6-3/16" NB round with ring	PVC	1/1
C33545	4"	6-3/16" NB round with ring	ABS	1/1
C33446	4"	6-3/16" PB round with ring	PVC	1/1
C33546	4"	6-3/16" PB round with ring	ABS	1/1

Adjustable Access Cover



- CI cover is for forklift or heavy trucking traffic
- NB and PB covers are for heavy pedestrian traffic
- Designed to fit over 2", 3" and 4" plastic adapter, cast iron cleanout, ferrules and various drainage piping (2" x 3" fits 2" and 3" bodies)
- 3 set screws allow for vertical adjustment

PART NO.	PIPE SIZE	COVER	HEIGHT	INSIDE C.O.	CTN/MSTR
C33001	2" & 3"	5-1/4" CI round with center screw	2-1/8"	4-9/16"	1/1
C33002	2" & 3"	5-1/2" NB round with ring	2-1/8"	4-9/16"	1/1
C33003	2" & 3"	5-1/2" PB round with ring	2-1/8"	4-9/16"	1/1
C33004	4"	6-3/16" CI round with center screw	2-5/8"	5-5/16"	1/1
C33005	4"	6-1/2" NB round with ring	2-5/8"	5-5/16"	1/1
C33006	4"	6-1/2" PB round with ring	2-5/8"	5-5/16"	1/1

Adjustable Floor Cleanout



- Adjusts 2-1/2"
- 4" cast iron body

PART NO.	PIPE SIZE	COVER	HEIGHT	INSIDE C.O.	CTN/MSTR
A40001	4"	5" CP	5-1/4"	3-3/4"	1/1
A40002	4"	5" PB	5-1/4"	3-3/4"	1/1
A40003	4"	5" NB	5-1/4"	3-3/4"	1/1

Heavy Duty Adjustable Access Cover



- Scoriated cover
- Fits any 6" pipe
- CI top is for forklift or heavy trucking traffic for up to 2000 lbs.
- 3 bolts secure the cleanout while puring concrete

PART NO.	PIPE SIZE	DESCRIPTION	HEIGHT	CTN/MSTR
C33088	6"	CI cleanout	3"	1/1

Heavy Duty Cleanout



- Scoriated cover
- Fits any 6" pipe
- 3 bolts secure the cleanout while puring concrete

PART NO.	PIPE SIZE	DESCRIPTION	HEIGHT	INSIDE C.O.	CTN/MSTR
D76005	6"	CI cleanout	5-3/8"	6-3/4"	1/1

F

Items marked with the Jones Stephens logo are "You Need It...We Got It" Items.

Cast Iron Commercial Cleanout Components

Pages 264-265

F

SIZES: 2", 3", 3-1/2", 4", 5", 6"

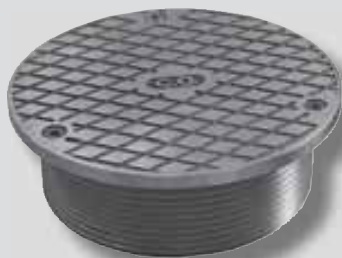

For use in
commercial applications.

No Hub Cleanout Body



PART NO.	PIPE SIZE	TAP SIZE	HEIGHT	CTN/MSTR
C37102	2" Body	1-1/2"	2-1/8"	1/10
C37103	3" Body	2-1/2"	2-1/8"	1/10
C37104	4" Body	3-1/2"	2-1/8"	1/10

Plain End Cast Iron Cleanout



- Short pattern less plug
- Fits flush with hub

PART NO.	PIPE SIZE	TAP SIZE	HEIGHT	CTN/MSTR
C37302	2"	1-1/2"	2-3/4"	1/12
C37303	3"	2-1/2"	3-1/2"	1/12
C37304	4"	3"	3"	1/8
C37314	4"	3-1/2"	3"	1/8

Plain End Cast Iron Cleanout



- Long pattern less plug
- Meets ASTM A-74

PART NO.	PIPE SIZE	TAP SIZE	HEIGHT	CTN/MSTR
C37002	2"	1-1/2"	2-3/4"	1/12
C37003	3"	2-1/2"	4"	1/12
C37004	4"	3"	4"	1/8
C37014	4"	3-1/2"	4"	1/8
C37005	5"	4"	3-1/2"	1/4
C37006	6"	5"	4"	1/2

No Hub Base



- Use with CI strainers or covers for heavy trucking traffic
- Use with PB, NB, SS or CP strainers or covers for heavy pedestrian traffic

PART NO.	PIPE SIZE	TAP SIZE	HEIGHT	CTN/MSTR
D63300	3"	3" IPS	4-1/4"	1/1
D63349	3"	3-1/2 IPS	4-1/4"	1/1
D63350	4"	3-1/2 IPS	4-1/4"	1/1
D63400	4"	4" IPS	4-1/4"	1/1

Gasket Connection Base



- Use with CI strainers or covers for heavy trucking traffic
- Use with PB, NB or CP strainers or covers for heavy pedestrian traffic
- Supplied with multi-tite gasket

PART NO.	PIPE SIZE	TAP SIZE	HEIGHT	CTN/MSTR
D62300	3"	3" IPS	5"	1/1
D62349	3"	3-1/2" IPS	5-1/4"	1/1
D62350	4"	3-1/2" IPS	5-1/4"	1/1
D62400	4"	4" IPS	5-1/4"	1/1

Cast Iron Spud with Cover for Heavy Duty Cleanout



NSF

- For use with heavy duty cleanouts

2-1/2" IPS Brass Plug with Round Cover

PART NO.	SIZE	COVER	CTN/MSTR
D62230	3"	5" CI round	1/1
D62231	3"	5" NB round with ring	1/1
D62232	3"	5" PB round with ring	1/1

3" IPS Brass Plug with Round Cover

PART NO.	SIZE	COVER	CTN/MSTR
D62235	3-1/2"	5" CI round	1/1
D62236	3-1/2"	6" NB round with ring	1/1
D62237	3-1/2"	6" PB round with ring	1/1

3-1/2" IPS Brass Plug with Round Cover

PART NO.	SIZE	COVER	CTN/MSTR
D62240	4"	5" CI round	1/1
D62241	4"	6" NB round with ring	1/1
D62242	4"	6" PB round with ring	1/1

Plastic Spud with Cover and Square Top for Heavy Duty Cleanout



- For use with heavy duty cleanouts
- Round cover with 7" square top

2-1/2" IPS Brass Plug with Square Top

PART NO.	SIZE	COVER	CTN/MSTR
D59912	3"	7" PB square	1/1
D59913	3"	7" NB square	1/1

3" IPS Brass Plug with Square Top

PART NO.	SIZE	COVER	CTN/MSTR
D59910	3-1/2"	7" PB square	1/1
D59911	3-1/2"	7" NB square	1/1

3-1/2" IPS Brass Plug with Square Top

PART NO.	SIZE	COVER	CTN/MSTR
D59918	4"	7" PB square	1/1
D59919	4"	7" NB square	1/1

Plastic Spud with Round Cover for Heavy Duty Cleanout



- For use with heavy duty cleanouts
- NSF listed

NSF

2-1/2" IPS Plastic Plug with Round Cover

PART NO.	SIZE	COVER	CTN/MSTR
D59904	3"	6" PB round	1/1
D59908	3"	6" PB round with ring	1/1
D59905	3"	6" NB round	1/1
D59909	3"	6" NB round with ring	1/1
D59940	3"	6" CI round with ring	1/1

3" IPS Plastic Plug with Round Cover

PART NO.	SIZE	COVER	CTN/MSTR
D59943	3-1/2"	5" PB round	1/1
D59944	3-1/2"	5" PB round with ring	1/1
D59945	3-1/2"	5" NB round	1/1
D59946	3-1/2"	5" NB round with ring	1/1
D59901	3-1/2"	6" PB round	1/1
D59906	3-1/2"	6" PB round with ring	1/1
D59902	3-1/2"	6" NB round	1/1
D59907	3-1/2"	6" NB round with ring	1/1
D59941	3-1/2"	6" CI round with ring	1/1
D59914	4"	6" PB round	1/1
D59915	4"	6" PB round with ring	1/1
D59916	4"	6" NB round	1/1
D59917	4"	6" NB round with ring	1/1
D59942	4"	6" CI round with ring	1/1

Metal Spud with Round Cover for Heavy Duty Cleanout



- For use with heavy duty cleanouts

2-1/2" IPS Brass Plug with Round Cover

PART NO.	SIZE	COVER	SCREWS	CENTER X CENTER	CTN/MSTR
C37803	3"	5" NB round	3	3-7/8"	1/20
C37801	3"	5" PB round	3	3-7/8"	1/20
C37800	3"	5" CP round	3	3-7/8"	1/20

3-1/2" IPS Brass Plug with Round Cover

PART NO.	SIZE	COVER	SCREWS	CENTER X CENTER	CTN/MSTR
C37810	3-1/2"	5" NB round	3	3-7/8"	1/18
C37811	3-1/2"	5" PB round	3	3-7/8"	1/18
C37805	4"	5" NB round	3	3-7/8"	1/20
C37806	4"	5" PB round	3	3-7/8"	1/20

4" IPS Brass Countersunk Plug with Round Cover

PART NO.	SIZE	COVER	SCREWS	CENTER X CENTER	CTN/MSTR
C37807	4"	6" NB round	2	4-7/8"	1/8
C37808	4"	6" PB round	2	4-7/8"	1/8

New Orleans Code Brass Plug



• Raised head

PART NO.	DESCRIPTION	O.D.	CTN/MSTR
P55150	1-1/2" plug	1-13/16"	1/200
P55250	2-1/2" plug	2-3/4"	1/100
P55300	3" plug	3-3/8"	1/60
P55350	3-1/2" plug	4"	1/80
P55500	5" plug	5-1/2"	1/30

Lead Fit-All Plug



• Raised head
• Cast iron cored
• Sizes are true measurement, not iron pipe size

F

PART NO.	DESCRIPTION	CTN/MSTR
P56200	2" fit-all plug	24/48
P56250	2-1/2" fit-all plug	24/48
P56300	3" fit-all plug	12/24
P56350	3-1/2" fit-all plug	12/24
P56400	4" fit-all plug	12/24
P56450	4-1/2" fit-all plug	12/12
P56500	5" fit-all plug	12/12
P56550	5-1/2" fit-all plug	12/12
P56600	6" fit-all plug	12/12

Southern Code Brass Plug



PART NO.	DESCRIPTION	O.D.	CTN/MSTR
P50100	1" raised head	1-9/32"	1/200
P50125	1- 1/4" raised head	1-5/8"	1/250
P50150	1-1/2" raised head	1-7/8"	1/200
P51150	1-1/2" countersunk	1-7/8"	1/200
P50200	2" raised head	2-3/8"	1/200
P51200	2" countersunk	2-3/8"	1/200
P50250	2-1/2" raised head	2-7/8"	1/200
P51250	2-1/2" countersunk	2-7/8"	1/200
P50300	3" raised head	3-3/8"	1/120
P51300	3" countersunk	3-3/8"	1/120
P50350	3-1/2" raised head	3-7/8"	1/90
P51350	3-1/2" countersunk	3-7/8"	1/120
P50400	4" raised head	4-1/2"	1/90
P51400	4" countersunk	4-1/2"	1/90
P50500	5" raised head	5-1/2"	1/50
P51500	5" countersunk	5-1/2"	1/50
P50600	6" raised head	6-1/2"	1/30
P51600	6" countersunk	6-1/2"	1/30
P50800	8" raised head	8-1/2"	1/15
P51800	8" countersunk	8-1/2"	1/15
P50999	10" raised head	10-5/8"	1/10

Heavy Pattern Brass Plug



PART NO.	DESCRIPTION	O.D.	CTN/MSTR
P52150	1-1/2" raised head	1-3/4"	1/100
P53150	1-1/2" countersunk	1-3/4"	1/200
P52200	2" raised head	2-3/8"	1/100
P53200	2" countersunk	2-3/8"	1/200
P52250	2-1/2" raised head	2-3/4"	1/60
P53250	2-1/2" countersunk	2-3/4"	1/100
P52300	3" raised head	3-1/2"	1/60
P53300	3" countersunk	3-1/2"	1/120
P52350	3-1/2" raised head	3-7/8"	1/60
P53350	3-1/2" countersunk	3-7/8"	1/80
P52400	4" raised head	4-3/8"	1/40
P53400	4" countersunk	4-3/8"	1/60
P52500	5" raised head	5-1/2"	1/30
P53500	5" countersunk	5-1/2"	1/40

Items marked with the Jones Stephens logo are "You Need It... We Got It" Items.

Code Pattern Plug



• Meets ASTM A74-98

PART NO.	DESCRIPTION	CTN/MSTR
P59300	3" raised head	1/50
P59333	3" countersunk	1/50
P59350	3-1/2" raised head	1/50
P59355	3-1/2" countersunk	1/50
P59400	4" raised head	1/50
P59444	4" countersunk	1/50

Slotted Brass Plug with 1/4" Tap



• Tap is not through the plug

PART NO.	DESCRIPTION	CTN/MSTR
P58150	1-1/2" slotted	1/150
P58200	2" slotted	1/100
P58250	2-1/2" slotted	1/80
P58300	3" slotted	1/60
P58350	3-1/2" slotted	1/40
P58400	4" slotted	1/30

Brass Plug For Extension Cover



• Countersunk plug tapped 1/4-20
• Tap is not through the plug

PART NO.	DESCRIPTION	O.D.	CTN/MSTR
P54150	1-1/2" countersunk	1-7/8"	1/200
P54200	2" countersunk	2-3/8"	1/200
P54250	2-1/2" countersunk	2-7/8"	1/150
P54300	3" countersunk	3-3/8"	1/100
P54350	3-1/2" countersunk	3-7/8"	1/100
P54400	4" countersunk	4-1/2"	1/80
P54500	5" countersunk	5-1/2"	1/40
P54600	6" countersunk	6-1/2"	1/30
P54800	8" countersunk	8-1/2"	1/12

Extension Cover Set



• Set includes stainless steel extension cover, brass countersunk or slotted plug and 1/4- 20 x 4" flat head machine screws

Wall Cover (24 gauge)

PART NO.	PLUG	COVER	CTN/MSTR
C92150	1-1/2" countersunk	3"	1/10
C92151	1-1/2" slotted	3"	1/10
C92200	2" countersunk	4"	1/10
C92202	2" slotted	4"	1/10
C92250	2-1/2" countersunk	5"	1/10
C92252	2-1/2" slotted	5"	1/10
C92300	3" countersunk	5"	1/10
C92301	3" countersunk	6"	1/10
C92303	3" slotted	6"	1/10
C92350	3-1/2" countersunk	6"	1/10
C92351	3-1/2" countersunk	7"	1/10
C92353	3-1/2" slotted	7"	1/10
C92400	4" countersunk	7"	1/10
C92404	4" slotted	7"	1/10
C92500	5" countersunk	8"	1/10
C92600	6" countersunk	8"	1/5
C92601	6" countersunk	10"	1/5
C92800	8" countersunk	10"	1/5

Floor Cover (16 gauge)

PART NO.	PLUG	COVER	CTN/MSTR
C93150	1-1/2" countersunk	3"	1/10
C93200	2" countersunk	4"	1/10
C93250	2-1/2" countersunk	5"	1/10
C93300	3" countersunk	5"	1/10
C93301	3" countersunk	6"	1/10
C93350	3-1/2" countersunk	6"	1/10
C93351	3-1/2" countersunk	7"	1/10
C93400	4" countersunk	7"	1/10
C93500	5" countersunk	8"	1/10

Stainless Steel Cleanout/Extension Cover



- Beveled edge
- 1500°F fire rating

Wall Mount (24 gauge)

PART NO.	SIZE	CTN/MSTR
C90300	3"	50/500
C90400	4"	25/200
C90500	5"	25/200
C90600 	6"	25/100
C90700	7"	25/100
C90800	8"	25/100
C90999	10"	25/50

Floor Mount (16 gauge)

PART NO.	SIZE	CTN/MSTR
C91300	3"	25/200
C91400	4"	25/200
C91500	5"	25/200
C91600	6"	25/100
C91700	7"	25/100
C91800	8"	25/50
C91999	10"	25/50

Wall Mount With 4" Bolt (24 gauge)

PART NO.	SIZE	CTN QTY
C90013	3"	25/200
C90014	4"	25/200
C90015	5"	25/200
C90016	6"	25/100
C90017	7"	25/100
C90018	8"	25/100
C90019	10"	25/50

Floor Mount With 4" Bolt (16 gauge)

PART NO.	SIZE	CTN QTY
C91013	3"	25/150
C91014	4"	25/150
C91015	5"	25/100
C91016	6"	25/75
C91017	7"	25/50
C91018	8"	25/50
C91019	10"	10/30

Bolts for Cleanout/Extension Covers



- Flat slotted head plated machine screw

PART NO.	SIZE	CTN/MSTR
C90002	1/4"- 20 x 2-1/2"	100/1000
C90004	1/4"- 20 x 4"	100/1500
C90006	1/4"- 20 x 6"	100/1200

High Impact Plastic Cleanout Cover Plate



- Polished chrome or white matte finish
- Individually bagged with # 14 wood screw included

Flat Design

PART NO.	SIZE	CTN/MSTR
C94004	4-1/4" chrome finish	25/200
C94005	5-1/4" chrome finish	25/200
C94007	7-1/4" chrome finish	25/200
C94009	9-1/4" chrome finish	25/100
C95004	4-1/4" white finish	25/200
C95005	5-1/4" white finish	25/200
C95007	7-1/4" white finish	25/200
C95009	9-1/4" white finish	25/100

Bell Design

PART NO.	SIZE	CTN/MSTR
C96004	4-1/4" chrome finish	25/200
C96005	5-1/4" chrome finish	25/200
C96007	7-1/4" chrome finish	25/200
C96009	9-1/4" chrome finish	25/100
C97004	4-1/4" white finish	25/200
C97005 	5-1/4" white finish	25/200
C97007	7-1/4" white finish	25/200
C97009	9-1/4" white finish	25/100

Trap Cover



- Stainless steel

PART NO.	DESCRIPTION	CTN/MSTR
C98001	5-3/4" Flat SS trap cover	150/300
C98002	5-3/4" Raised SS trap cover	50/200

Stainless Steel Dome Cover Plate



- 1-1/2" depth
- 1500°F fire rating
- High grade stainless steel
- Individually bagged with # 14 wood screw and 1/4" x 2-1/2" machine screw

PART NO.	DESCRIPTION	CTN/MSTR
C98014	4" SS dome cover plate	60/240
C98016	6" SS dome cover plate	50/150
C98018	8" SS dome cover plate	50/100

 Items marked with the Jones Stephens logo are "You Need It... We Got It" Items.

Inside Caulk Bell Trap



- Hinged lid
- Bell attached

PIPE SIZE	BODY	STRAINER	OUTLET HEIGHT	OVERALL HEIGHT
2"	6" x 6"	4-7/8"	1-3/4"	4-1/8"
3"	9" x 9"	6-3/4"	1-7/8"	4-7/8"
4"	12" x 12"	9-3/4"	1-3/4"	4-7/8"

PART NO.	DESCRIPTION	CTN/MSTR
D76202	6" x 6" x 2"	1/1
D76203	9" x 9" x 3"	1/1
D76204	12" x 12" x 4"	1/1

Strainers less Hinge

PART NO.	DESCRIPTION	CTN/MSTR
D76205L	4-7/8" strainer for 6" x 6"	1/20
D76207L	6-3/4" strainer for 9" x 9"	1/20

Cast Iron Bell with Nut and Bolt

PART NO.	SIZE	CTN/MSTR
D76256	Bell for 6" x 6"	1/20
D76259	Bell for 9" x 9"	1/20
D76252	Bell for 12" x 12"	1/10

No Hub Bell Trap



- Spigot outlet
- Hinged lid
- Bell attached

PIPE SIZE	BODY	STRAINER	OUTLET HEIGHT	OVERALL HEIGHT
2"	6" x 6"	4-7/8"	1-1/4"	3-1/4"
3"	9" x 9"	6-3/4"	1-1/2"	4-1/4"
4"	12" x 12"	9-3/4"	1-1/2"	4-7/8"

PART NO.	DESCRIPTION	CTN/MSTR
D76302	6" x 6" x 2"	1/1
D76303	9" x 9" x 3"	1/1
D76304	12" x 12" x 4"	1/1

Strainers less Hinge

PART NO.	DESCRIPTION	CTN/MSTR
D76205L	4-7/8" strainer for 6" x 6"	1/20
D76207L	6-3/4" strainer for 9" x 9"	1/20
D76209L	9-3/4" strainer for 12" x 12"	1/10

Cast Iron Bell with Nut and Bolt

PART NO.	DESCRIPTION	CTN/MSTR
D76256	Bell for 6" x 6"	1/20
D76259	Bell for 9" x 9"	1/20
D76252	Bell for 12" x 12"	1/10

Spigot Outlet Bell Trap



- Loose lid
- Bell cast on

PIPE SIZE	BODY	STRAINER	OUTLET HEIGHT	OVERALL HEIGHT
2"	6" x 6"	4-7/8"	1-3/8"	3-1/2"
3"	9" x 9"	6-3/4"	1-1/2"	4-1/2"
4"	12" x 12"	9-3/4"	1-1/2"	4-7/8"

PART NO.	DESCRIPTION	CTN/MSTR
D76402	6" x 6" x 2"	1/1
D76403	9" x 9" x 3"	1/1
D76404	12" x 12" x 4"	1/1

Replacement Strainer with Cast-In Bell

PART NO.	DESCRIPTION	CTN/MSTR
D76412	4-7/8" cast-in bell for 6" x 6"	1/20
D76413	6-3/4" cast-in bell for 9" x 9"	1/20
D76414	9-3/4" cast-in bell for 12" x 12"	1/10

Pittsburgh Bell Trap



- Deep body
- 4" inside caulk

PIPE SIZE	BODY	STRAINER	OVERALL HEIGHT
4"	9" x 9"	6-3/4"	4-1/2"

PART NO.	DESCRIPTION	CTN/MSTR
B60994	9" x 9" x 4" inside caulk less bell	1/1

Strainer Only (Loose Lid)

PART NO.	DESCRIPTION	CTN/MSTR
B60099	6-3/4" ID strainer	1/1

F

Heavy Duty Floor Drain



- 8-1/2" heavy duty cast iron grate
- Cast iron sediment bucket

No Hub less Sediment Bucket					
PART NO.	SIZE	PAN	GRATE	HEIGHT	CTN/MSTR
D79703	3"	10-1/2"	9" CI	5 1/4"	1/1
D79704	4"	10-1/2"	9" CI	5 1/4"	1/1
No Hub with Sediment Bucket					
PART NO.	SIZE	PAN	GRATE	HEIGHT	CTN/MSTR
D79705	3"	10-1/2"	9" CI	5 1/4"	1/1
D79706	4"	10-1/2"	9" CI	5 1/4"	1/1
Inside Caulk less Sediment Bucket					
PART NO.	SIZE	PAN	GRATE	HEIGHT	CTN/MSTR
D79805	3"	10-1/2"	9" CI	5 1/4"	1/1
D79806	4"	10-1/2"	9" CI	5 1/4"	1/1
Inside Caulk with Sediment Bucket					
PART NO.	SIZE	PAN	GRATE	HEIGHT	CTN/MSTR
D79803	3"	10-1/2"	9" CI	5 1/4"	1/1
D79804	4"	10-1/2"	9" CI	5 1/4"	1/1
Sediment Bucket					
PART NO.	DESCRIPTION				CTN/MSTR
D50095	CI sediment bucket				1/1

Code Blue No Caulk (Mechanical Joint) Cesspool Drain



- Supplied with stainless steel bolts
- Includes test plug
- UPC listed

PART NO.	SIZE	STRAINER	HEIGHT	CTN/MSTR
D76702	2"	6" CI	4 1/16"	1/1
D76703	3"	7" CI	4 1/16"	1/1
D76704	4"	8" CI	4 1/16"	1/1



- 3/4" Thick

PART NO.	DESCRIPTION	CTN/MSTR
D76705	Grate for D76702	1/1
D76707	Grate for D76704	1/1

Caulk Cesspool with Recessed Grate



PART NO.	DESCRIPTION	CTN/MSTR
D76504	12" x 12" x 4"	1/1
D76519	Grate only	1/1

Rainleader Cesspool



- For areas requiring downspout, rainleader and cesspool drain
- Grate secured by screw
- 12-3/4" diameter pan fits over outlet

PART NO.	DESCRIPTION	CTN/MSTR
J60030	4" hub inlet x 4" spigot outlet	1/1

Square Cesspool Grate



PART NO.	DESCRIPTION	CTN/MSTR
D59156	6" x 6" square grate	1/10
D59158	8" x 8" square grate	1/5
D59160	10" x 10" square grate	1/2
D59162	12" x 12" square grate	1/2

Round Slop Sink, Hydrant Cesspool



- 2" IPS outlet
- Removable Strainer

PART NO.	DESCRIPTION	CTN/MSTR
S55100	2" IPS ink painted	1/1
S55101	2" IPS galvanized cast iron	1/1

Square Hydrant Cesspool



- Grate included
- Spigot outlet

PART NO.	DESCRIPTION	CTN/MSTR
S57034	11" x 11" x 4"	1/1
S57035	Grate only	1/1

Porcelain Coated Floor Sink



- 12"x 12" white porcelain coated cast iron
- No hub and inside caulk
- Aluminum dome bottom strainer included

PART NO.	DESCRIPTION	CTN/MSTR
S55104	4" inside caulk 6" deep	1/1
S55004	4" inside caulk 8" deep	1/1
S55112	2" no hub 6" deep	1/1
S55113	3" no hub 6" deep	1/1
S55114	4" no hub 6" deep	1/1

Top Grates Only To Fit Floor Sinks



PART NO.	DESCRIPTION	CTN/MSTR
S55010	Full top grate	1/1
S55075	Three-quarter top grate	1/1
S55050	Half top grate	1/1

Aluminum Bottom Dome for Cast Iron Sink



- Fits all sizes porcelain coated cast iron sinks

BOTTOM OD	HEIGHT
5-3/8"	2-1/4"

PART NO.	DESCRIPTION	CTN/MSTR
S55115	Aluminum bottom dome- Fit All	1/1
S60002	2" aluminum bottom dome	1/10
S60003	3" aluminum bottom dome	1/10
S60004	4" aluminum bottom dome	1/10

Plumlock Porcelain Floor Sink



- 12"x 12" white porcelain coated cast iron
- Aluminum dome strainer included
- Push-On Connection; gasket supplied

PART NO.	DESCRIPTION	CTN/MSTR
S55122	2" Plumlock floor sink- 6" deep	1/1
S55123	3" Plumlock floor sink- 6" deep	1/1
S55124	4" Plumlock floor sink- 6" deep	1/1

Plumlock Gasket for Cast Iron or Schedule 40 Pipe Connectors



- Fits 12" x 12" white porcelain coated cast iron Plumlock Sinks

PART NO.	DESCRIPTION	CTN/MSTR
S55192	2" PlumLock gasket	1/1
S55193	3" PlumLock gasket	1/1
S55194	4" PlumLock gasket	1/1

Service Sink Faucet



- Chrome plated
- Integral stops
- Integrated vacuum breaker
- Complete with all mounting hardware
- Meets ASSE 1001
- Front hook to hang bucket

PART NO.	DESCRIPTION	CTN/MSTR
S55349	Service sink faucet with lever handles	1/8
S55350	Service sink faucet w/cross handles	1/6
S55352	Lever handle stem repair kit for S55349	1/100
S55353	Integral stop repair kit for S55349	1/100
S55354	Vacuum breaker repair kit (S55349 or S55350)	1/100

Trap Standard



- Cast iron body with white coating
- Chrome plated brass strainer
- Fits American Standard*, Kohler*, Eljer* and Crane* cast iron service sinks

PART NO.	DESCRIPTION	CTN/MSTR
T00002	2" IPS	1/1
T00003	3" IPS	1/1
T00005	Base plate for trap standard	1/1
T00006	1-1/2" N.O. plug with gasket	1/1
T00009	Strainer and stud for trap standard	1/1

* The manufacturers' names are used only to describe whose products the products will fit.

Mop Service Basin



- One-piece molded construction; 24" x 24" x 10"
- Crushed stone with polyester resin
- Supplied with 3" gasketed connection and stainless steel strainer

PART NO.	DESCRIPTION	CTN/MSTR
S55240	Mop service basin	1/1

Hose and Bracket for Service Sink



- Heavy duty 300# cloth-reinforced hose
- 5" x 3" stainless steel bracket with rubber grip
- 3/4" brass hose coupling at one end

PART NO.	DESCRIPTION	CTN/MSTR
M05001	Hose with bracket	1/1

Mop Hanger for Service Sink



- 24" x 3" stainless steel hanger with three rubber tool grips
- Anchors included

PART NO.	DESCRIPTION	CTN/MSTR
M05003	Mop hanger	1/25

Roof Drain with Cast Iron Dome



- 10" diameter pan
- Dome has 50 sq. Inches of drain area
- Cast iron dome

PART NO.	SIZE	PAN	DOMES	HEIGHT	CTN/MSTR
R19003	3" inside caulk	10"	5-1/2"	8"	1/1
R19005	3" no hub	10"	5-1/2"	8"	1/1
R19004	4" inside caulk	10"	5-1/2"	8"	1/1
R19006	4" no hub	10"	5-1/2"	8"	1/1
R18020	Cast iron roof dome		5-1/2"		1/1

Code Blue No Hub Roof Drain with Square Pan



- 8 1/2" square pan
- Cast iron dome and drain
- Supplied with stainless steel bolts
- UPC listed



PART NO.	SIZE	PAN	HEIGHT	CTN/MSTR
R19202	2" No Hub	8-1/2"	9-1/2"	1/1
R19203	3" No Hub	8-1/2"	9-3/4"	1/1
R19204	4" No Hub	8-1/2"	9-3/4"	1/1
R19206	6" No Hub	8-1/2"	9-3/4"	1/1

Code Blue No Caulk (Mechanical Joint) Roof Drain with Square Pan

F



- 8 1/2" square pan for 2" and 3" outlet
- 15" pan for 4" outlet
- Cast iron dome and drain
- Supplied with stainless steel bolts
- UPC listed



PART NO.	SIZE	STRAINER	HEIGHT	CTN/MSTR
R19102	2" no caulk	8-1/2"	9-1/2"	1/1
R19103	3" no caulk	8-1/2"	9-1/2"	1/1
R19104	4" no caulk	8-1/2"	9-1/2"	1/1

Code Blue No Hub Dual Roof Drain



- Supplied with stainless steel bolts
- Overflow
- UPC listed

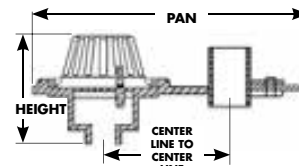

PIPE SIZE	CENTER TO CENTER	PAN	OVERALL HEIGHT	
			SINGLE	DOUBLE
2"	8-1/2"	19"	8"	8-1/2"
3"	8-1/2"	19"	9-1/2"	10"
4"	8-1/2"	19"	10"	10-1/2"

Single Dome

PART NO.	SIZE	PAN	CTN/MSTR
R19302	2" no hub dual drain	19"	1/1
R19303	3" no hub dual drain	19"	1/1
R19304	4" no hub dual drain	19"	1/1

Double Dome

PART NO.	SIZE	PAN	CTN/MSTR
R19307	2" no hub dual dome drain	19"	1/1
R19305	3" no hub dual dome drain	19"	1/1
R19306	4" no hub dual dome drain	19"	1/1

Replacement Parts

PART NO.	SIZE	CTN/MSTR
R19099	Roof drain dome	1/1
R19100	Clamping ring	1/1

Code Blue No Hub Side Outlet Roof Drain with Square Pan



PART NO.	SIZE	PAN	HEIGHT	CTN/MSTR
R19402	2"	8-1/2"	9-1/2"	1/1
R19403	3"	8-1/2"	9-1/2"	1/1
R19404	4"	8-1/2"	9-1/2"	1/1

Bar Grate



• For hub openings in soil pipe

PART NO.	DESCRIPTION	DIAMETER	CTN/MSTR
D59102	2" (less legs)	2-3/4"	1/10
D59103	3" (less legs)	3-1/2"	1/10
D59104	4" (less legs)	4-7/8"	1/10
D59106	6" (less legs)	6-7/8"	1/10
D59101	4" (less legs)	4-7/8"	1/10
D59112	2" (with legs)	2-3/4"	1/10
D59113	3" (with legs)	3-3/4"	1/10
D59114	4" (with legs)	4-7/8"	1/10

Perforated Sewer Strainer with Legs



• For hub openings in clay sewer pipe

PART NO.	DESCRIPTION	DIAMETER	CTN/MSTR
D59124	4" sewer strainer	5-1/2"	1/10
D59126	6" sewer strainer	7-3/8"	1/5
D59128	8" sewer strainer	10-1/8"	1/5
D59130	10" sewer strainer	12-1/4"	1/2
D59132	12" sewer strainer	14-1/4"	1/2

Sewer Box



• Sewer lid is marked "sewer"
• Water lid is marked "water"
• Plain lid is unmarked

PART NO.	DESCRIPTION	CTN/MSTR
S36006	8" water lid and ring	1/1
S36007	8" sewer lid	1/1
S36008	8" sewer lid and ring	1/1
S36090	8" plain lid	1/1
S36091	8" plain lid and ring	1/1
S36011	10" water lid and ring	1/1
S36009	10" sewer lid only	1/1
S36010	10" sewer lid and ring	1/1
S36095	10" plain lid	1/1
S36096	10" plain lid and ring	1/1

Ohio Style Grate



• Cast iron grate

PART NO.	DESCRIPTION	CTN/MSTR
J60006	6" Ohio style grate	1/1

Water Access Box



• Lockable lid

PART NO.	DESCRIPTION	CTN/MSTR
J60026	6" x 6" x 2" water access box	1/6

Perforated Vent Box



PART NO.	DESCRIPTION	CTN/MSTR
J60027	6" x 6" x 2" perforated vent box	1/6

Philadelphia Style Vent Box



• Strainer secured by overlapping lug and screw
• Integral cast baffles

PART NO.	DESCRIPTION	CTN/MSTR
J60004	4" inside caulk	1/1
J60094	Replacement strainer	1/1

Fresh Air Inlet/Floor Drain



PART NO.	DESCRIPTION	CTN/MSTR
J60007	3" spigot	1/15
J60008	4" spigot	1/15

Vent Cap



• Cast iron cap for 3" or 4" pipe

PART NO.	DESCRIPTION	CTN/MSTR
J60005	3" - 4" vent cap	1/10

Lockable Vent Cap



- Cast iron grate fits inside spigot end of pipe
- Secured with adjustable screw and clamp

PART NO.	DESCRIPTION	CTN/MSTR
J60010	4" cast iron vent cap	1/10

Brass Deck Plug



- Inside caulk
- Polished brass ring
- Cast brass body
- Skid-resistant scoriated lid

PART NO.	DESCRIPTION	CTN/MSTR
D28003	3" deck plug	1/20
D28004	4" deck plug	1/12

F

Blind Plugs



No Hub		
PART NO.	DESCRIPTION	CTN/MSTR
D59202	2" blind plug	1/10
D59203	3" blind plug	1/10
D59204	4" blind plug	1/8

Service Weight		
PART NO.	DESCRIPTION	CTN/MSTR
D59302	2" blind plug	1/10
D59303	3" blind plug	1/8
D59304	4" blind plug	1/4

Reading Style Cleanout



- 4" Inside caulk

PART NO.	DESCRIPTION	CTN/MSTR
J60012	Reading cleanout	1/1

Cast Iron Backwater Valves



- Reduces backflow in drainage system
- All neoprene gaskets
- 300 series stainless bolts and washers
- Repairable in service
- Revolutionary design- that works!
- UPC listed

Service Weight					
PART NO.	SIZE	LENGTH	HUB	CTN/MSTR	
B01013	3"	10-3/4"	5-1/8"	1/1	
B01014	4"	11-3/4"	6-1/2"	1/1	
B01016	6"	12-3/4"	7-1/4"	1/1	

No Hub					
PART NO.	SIZE	LENGTH	HUB	CTN/MSTR	
B01002	2"	10-3/4"	—	1/1	
B01003	3"	11-3/4"	—	1/1	
B01004	4"	12-3/4"	—	1/1	
B01006	6"	14-1/2"	—	1/1	

Replacement Flappers		
PART NO.	DESCRIPTION	CTN/MSTR
B01017	2" bolt-in flapper and ring	1/1
B01018	3" bolt-in flapper and ring	1/1
B01019	4" bolt-in flapper and ring	1/1
B01020	6" bolt-in flapper and ring	1/1

Reading Style Vent



- 4" Inside caulk

PART NO.	DESCRIPTION	CTN/MSTR
J60011	Reading vent	1/1

Items marked with the Jones Stephens logo are "You Need It... We Got It" Items.

Test Tee



- Available with or without plug
- Plug is Southern Code

Service Weight Tee

PART NO.	DESCRIPTION	LENGTH	PLUG	CTN/MSTR
T55002	2"x 2" less plug	10-3/8"	2"	1/1
T55012	2"x 2" with plug	10-3/8"	2"	1/1
T55003	3"x 3" less plug	12-1/2"	3"	1/1
T55013	3"x 3" with plug	12-1/2"	3"	1/1
T55004	4"x 4" less plug	13-7/8"	4"	1/1
T55014	4"x 4" with plug	13-7/8"	4"	1/1

No Hub Tee

PART NO.	DESCRIPTION	LENGTH	PLUG	CTN/MSTR
T56002	2"x 2" less plug	6-3/8"	2"	1/1
T56012	2"x 2" with plug	6-3/8"	2"	1/1
T56003	3"x 3" less plug	7-3/4"	3"	1/1
T56013	3"x 3" with plug	7-3/4"	3"	1/1
T56004	4"x 4" less plug	8-7/8"	4"	1/1
T56014	4"x 4" with plug	8-7/8"	4"	1/1

Test Tee with Heavy Plug



Service Weight Tee

PART NO.	DESCRIPTION	LENGTH	PLUG	CTN/MSTR
T55022	2"x 2" with plug	10-3/8"	2"	1/1
T55033	3"x 3" with plug	12-1/2"	3"	1/1
T55044	4"x 4" with plug	13-7/8"	4"	1/1

No Hub Tee

PART NO.	DESCRIPTION	LENGTH	PLUG	CTN/MSTR
T56022	2"x 2" with plug	6-3/8"	2"	1/1
T56033	3"x 3" with plug	7-3/4"	3"	1/1
T56044	4"x 4" with plug	8-7/8"	4"	1/1

Cast Iron Single Vent Running Trap



PART NO.	DESCRIPTION	CTN/MSTR
T64540	5"x 4" single vent running trap	1/1
T63106	6"x 4" single vent running trap	1/1

Tapped Saddle Tee



- U-bolt included

PART NO.	DESCRIPTION	CTN/MSTR
T21001	3"x 1 1/2"	1/1
T21002	3"x 2"	1/1
T21003	4"x 1 1/2"	1/1
T21004	4"x 2"	1/1
S26008	6" x 7" (1/4" thick) closed cell foam gasket	1/1

Repair Plate



- U-bolt included

PART NO.	DESCRIPTION	CTN/MSTR
T21062	2" plate with u-bolt	1/1
T21063	3" plate with u-bolt	1/1
T21064	4" plate with u-bolt	1/1

F

“T” Burner Bar



- 12-1/4" long by 1-3/8" high, tapped 1/2" IPS in ends and bottom
- Supplied with two 1/2" plugs and close nipple orifice

PART NO.	DESCRIPTION	LENGTH	HEIGHT	CTN/MSTR
L75080	Natural Gas	12-1/4"	1-3/8"	1/10
L75180	LPG	12-1/4"	1-3/8"	1/10

Two Leg Burner



- Dimensions 14" long x 1-3/4" high x 2-1/4" wide
- Tapped 1/2" IPS on both ends and one leg
- Comes with two 1/2" IPS plugs and close nipple orifice
- Ledge over burner holes prevents clogging

PART NO.	DESCRIPTION	LENGTH	HEIGHT	CTN/MSTR
L75081	Natural Gas	14"	1-3/4"	1/10
L75181	LPG	14"	1-3/4"	1/10

Round Burner



- 1-3/4" high x 4 1/2" wide, tapped 1/2" IPS in bottom and sides
- Supplied with close nipple orifice and 1/2" plug

PART NO.	DESCRIPTION	WIDTH	HEIGHT	CTN/MSTR
L75086	Natural Gas	4-1/2"	1-3/4"	1/10
L75186	LPG	4-1/2"	1-3/4"	1/10

Rectangular Burner



- Dimensions 8-3/4" long x 1-1/2" high x 1-3/4" wide with 1/2" IPS inlet
- Supplied with close nipple orifice and removable lid
- Low profile

PART NO.	DESCRIPTION	LENGTH	HEIGHT	CTN/MSTR
L75085	Natural Gas	8-3/4"	1-1/2"	1/10
L75185	LPG	8-3/4"	1-1/2"	1/10

Log Lighter Burner Bar



- Air mixing chamber
- Straight: 17" pipe plus 3" mixing chamber
- T-Pattern: Two 7" pipes plus 3" mixing chamber

PART NO.	DESCRIPTION	CTN/MSTR
L75091	Straight for natural gas	1/10
L75092	Straight for LPG	1/10
L75095	T-pattern for natural gas	1/10
L75096	T-pattern for LPG	1/10

Log Lighter Valves

- CSA design certified
- Zinc escutcheon
- 1/4" Key included
- Individually tested (pressure test in open and closed position after installation)
- BTU rating: angle 188,000, straight 120,000
- To extend escutcheon use 1/2" pipe coupling and 1/2" pipe nipple

Standard Valve (7 turns open/close)



PART NO.	DESCRIPTION	CTN/MSTR
L75001	Chrome plated angle	1/36
L75002	Polished brass angle	1/36
L75006	Chrome plated straight	1/36
L75007	Polished brass straight	1/36

Ball Valve (1/4" turn)



PART NO.	DESCRIPTION	CTN/MSTR
L75040	Chrome plated angle	1/36
L75041	Polished brass angle	1/36
L75042	Chrome plated straight	1/36
L75043	Polished brass straight	1/36

Escutcheons Only

PART NO.	DESCRIPTION	CTN/MSTR
L75908	Chrome plated	1/36
L75909	Polished brass	1/36

Items marked with the Jones Stephens logo are "You Need It... We Got It" Items.

2-Way Combo Log Lighter Valve



- Straight or angle pattern
- 5/16" key and brass plug for extra outlet included

PART NO.	FINISH	CTN/MSTR
L75009	Chrome plated	1/10
L75010	Polished brass	1/10

Log Lighter Valve with T-Burner



- Solid brass escutcheon, 1/4" key and close nipple orifice included
- Individually tested (pressure test open and closed after installation)
- Angle: 188,000 BTU/Straight: 120,000 BTU

PART NO.	DESCRIPTION	CTN/MSTR
L75406	Chrome plated angle natural gas	1/1
L75407	Polished brass angle natural gas	1/1
L75408	Chrome plated straight natural gas	1/1
L75409	Polished brass straight natural gas	1/1
L75400	Chrome plated angle LPG	1/1
L75401	Polished brass angle LPG	1/1
L75402	Chrome plated straight LPG	1/1
L75403	Polished brass straight LPG	1/1

Log Lighter Keys and Accessories



• 1/4" and 5/16" drives on keys

PART NO.	SIZE	MATERIAL	CTN/MSTR
L75019	1/4"x 3"	Brass	1/200
L75020	5/16"x 3"	Brass	1/200
L75021	1/4"x 6"	Brass	1/240
L75023	5/16"x 6"	Brass	1/240
L75022	1/4"x 12"	Brass	1/100
L75024	5/16"x 12"	Brass	1/100



PART NO.	DESCRIPTION	MATERIAL	CTN/MSTR
L75017	1/4"x 3"	Die cast zinc	1/250
L75018	5/16"x 3"	Die cast zinc	1/250

Close Nipple Orifices



PART NO.	DESCRIPTION	CTN/MSTR
L75015	7/64" Orifice for natural gas	1/1
L75016	5/64" Orifice for LP gas	1/1

TOOLS..... 281-309

G

Tub and Shower Valve Wrench Set



- Plated steel
- Complete set with handle includes: 21/32" x 27/32", 29/32" x 31/32", 1-1/32" x 1-3/32", 1-11/32" x 1-7/16", 1-5/32" x 1-9/32"

PART NO.	DESCRIPTION	CTN/MSTR
J40002	Valve wrench set	1/20
J40000	21/32" x 27/32" wrench only	20/100
J40001	1-1/32" x 1-3/32" wrench only	20/100
J40006	29/32" x 31/32" wrench only	50/100
J40008	1-11/32" x 1-7/16" wrench only	1/100

Garbage Disposal Wrench



- 1/2" steel
- 10" long

PART NO.	DESCRIPTION	CTN/MSTR
J40025	Disposal wrench	25/50

4-Way Key



- Plated steel
- For valve, faucet and sillcock sizes 1/4", 9/32", 5/16" and 11/32"
- Carded

PART NO.	DESCRIPTION	CTN/MSTR
J40005	4-way key	25/100

No Hub Torque Wrench



- For 5/16"
- Automatic release at 60 in.lb.
- Built-in reversing lever
- Ratchets one way
- Chrome vanadium socket
- Carded

PART NO.	DESCRIPTION	CTN/MSTR
T60060	No hub torque wrench	20/80

Mega Torque Wrench



- Slide down locking reversing feature
- Heavy duty construction with chrome vanadium sockets

PART NO.	DESCRIPTION	CTN/MSTR
T60065	60 lb. with 5/16" socket	15/60
T60080	80 lb. with 3/8" socket	15/60
T60081	80 lb. with 5/16" socket	15/60
T60066	5/16" Socket kit	15/60

Element Wrench



- Zinc plated steel
- 1-1/2" ID - 1-3/4" OD
- For removing heater elements

PART NO.	DESCRIPTION	CTN/MSTR
J36100	Regular unit wrench	25/100
J36101	Heavy duty wrench	25/50

Sillcock Key



- Die cast
- 5/16" and 1/4"

PART NO.	DESCRIPTION	CTN/MSTR
J40003	1/4" Sillcock key	1/400
J40004	5/16" Sillcock key	1/400

14 Piece Folding Hex Key Wrench Set



- Chrome plated steel case
- Fourteen fractional U.S. sizes
- Carded

PART NO.	DESCRIPTION	CTN/MSTR
J40015	Hex key wrench set	12/72

Basin Wrench



- Spring-hinged jaw
- Telescoping body allows for easier use in hard-to-reach areas
- Swivel head operates from either right or left side
- Use on hard-to-reach basin nuts, ballcocks and flush valves
- B11013 is carded

PART NO.	DESCRIPTION	JAW	CTN/MSTR
B11010	10" - 17" telescoping	1-1/4"	10/30
B11011	11-3/8" long non-telescoping	1-1/4"	20/40
B11012	9-1/2" - 16-1/2" telescoping	2"	15/30
B11013	Spring hinged replacement jaw for B11011	-	20/100

Radiator Spud Wrench



- Plated malleable iron
- For use as spud key and wrench

PART NO.	DESCRIPTION	CTN/MSTR
J40030	Radiator spud wrench	10/20

Items marked with the Jones Stephens logo are "You Need It... We Got It" Items.

3-N-1 Radiator Repair Tool



- Steel
- For re-tapping and reaming out radiators
- Carded

PART NO.	DESCRIPTION	CTN/MSTR
J40034	3-N-1 radiator repair tool	6/72

4-Way P.O. Plug Wrench



- For installing or removing basket strainers, tub drains and P.O. plugs

PART NO.	DESCRIPTION	CTN/MSTR
J40026	4-way P.O. plug wrench	20/60

4-Way Plug Wrench



- For installing or removing countersunk plugs

PART NO.	DESCRIPTION	CTN/MSTR
J40040	4-way countersunk plug wrench	1/20

4-Way Countersunk Plug Wrench



- For installing or removing countersunk plugs

PART NO.	DESCRIPTION	CTN/MSTR
J40041	4-way countersunk plug wrench	5/15

6-Way Countersunk Plug Wrench



- 4 head sizes for square plugs
- 2 head sizes for slotted plugs
- Extra-strong iron construction

PART NO.	DESCRIPTION	CTN/MSTR
J40042	6-way wrench	1/20

Faucet Seat Repair Kit



- Reversible cone
- 4 sizes of cutters
- Hardened steel cutters smooth worn seats
- Saves repair costs; stops faucet drips
- Kit includes faucet washers and bibb screw
- Carded

PART NO.	DESCRIPTION	CTN/MSTR
J40007	Faucet seat repair kit	12/120

Faucet Seat Wrench



- Tapered for use on all sizes and types of seats

PART NO.	DESCRIPTION	CTN/MSTR
S62001	Straight tapered wrench	100/200
S62002	Angle tapered wrench	20/60
S62003	Straight stepped wrench	100/200
S62004	Angle stepped wrench	20/60

Seat Wrench for Recessed Seats



- Works in hard-to-reach recessed seats

PART NO.	DESCRIPTION	CTN/MSTR
S62005	Seat wrench for recessed seats	50/100

Dual Kwik Tite Wrench



- Install stops easily
- Tightens 3/8" supply nuts
- Carded

PART NO.	DESCRIPTION	CTN/MSTR
J40490	Dual kwik tite wrench	10/60

Lavatory Nut Removal Tool



- Lightweight, high strength plastic
- For 7/8" metal or plastic hex nuts
- Extra long to reach mounting nuts on faucets, sprayers, and ballcocks
- Bagged

PART NO.	DESCRIPTION	CTN/MSTR
J40035	Lavatory nut removal tool	10/50

Universal Drain Wrench



- 6" long
- Die cast aluminum
- Installs and removes tub drains and closet spuds
- Prevents damage to decorative finishes
- Use crescent wrench or screwdriver to turn tool
- Carded

PART NO.	DESCRIPTION	CTN/MSTR
J45010	Universal drain wrench	12/48

Angle Compression Stop Wrench



- Fits 3/8" compression or 1/2" male IPS outlet threads on angle stops
- Protects finishes
- Carded

PART NO.	DESCRIPTION	CTN/MSTR
J40491	Angle compression stop wrench	10/60

G

Extract-a-Drain Tub Drain Removal Tool



- Removes old or rusty drains - even drains with missing crossbars!
- Fits both 1-3/8" and 1-1/2" tub drains
- Jaws expand to firmly grip the inside of the drain
- Prevents damage to your tub's finish
- A wrench is the only other tool that you'll need to complete this job

PART NO.	DESCRIPTION	CTN/MSTR
J40018	Extract-a-drain tool	1/50

Compression Sleeve Puller

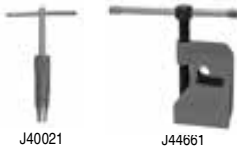

- Removes leaking compression sleeves without damaging walls
- Unique armless design - screws directly into compression nut for fast removal
- For 5/8" compression nuts
- Made in the USA (J40021)
- Carded



PART NO.	DESCRIPTION	CTN/MSTR
J40021	Compression sleeve puller	1/35
J44661	Compression sleeve puller - 1/2" OD	10/40

Compression Sleeve Puller Adapter



- Converts any standard faucet handle puller to remove compression sleeves

PART NO.	DESCRIPTION	CTN/MSTR
J40013	Adapter	50/100

E-ZEE Pull Deluxe Faucet Handle Puller



- 4" bracket width
- Pulls all size handles
- Forged steel with case - hardened pin

PART NO.	DESCRIPTION	CTN/MSTR
J40012	E-ZEE pull deluxe faucet handle puller	25/50

Faucet Handle Puller



- Plated steel
- Removes faucet and valve handles
- J40010 is carded

PART NO.	DESCRIPTION	CTN/MSTR
J40010	Standard unit (carded)	25/50
J40011	Heavy duty impact unit	15/30

Quick Drain Wrench



- Installs no caulk shower drains quickly
- Provides tongue to seal drain

PART NO.	DESCRIPTION	CTN/MSTR
J40235	Quick drain wrench	10/60

Sink Drain Wrench



- Fits kitchen, bath and laundry tub basket strainers, p-traps, wing nuts and tub drains
- Made in the USA



PART NO.	DESCRIPTION	CTN/MSTR
J40023	Sink drain wrench	1/24

Moen Stem and Cartridge Wrench



- Removes Moen stems and cartridges
- Works on plastic and brass faucet and shower valves
- Carded

PART NO.	DESCRIPTION	CTN/MSTR
J45015	Stem and cartridge wrench	12/72

Adjustable Strainer and Spud Wrench



- Plated
- Fits closet spuds, basket strainers, lock nuts and slip nuts
- Adjustment 7/8" to 3-1/8"

PART NO.	DESCRIPTION	CTN/MSTR
J40022	Strainer & spud wrench	20/40

Spud Wrench



- For strainer, lock and slip nuts
- 1" - 3" capacity
- Heat treated forging

PART NO.	DESCRIPTION	CTN/MSTR
J40305	Spud wrench	20/40

Spud Wrench with Hinged Arm



PART NO.	DESCRIPTION	CTN/MSTR
J40306	Spud wrench with hinged arm	30/60

Spanner/Strainer Wrench



- Plated malleable iron
- Used for basket strainer jam nuts

PART NO.	DESCRIPTION	CTN/MSTR
J40024	Spanner/strainer wrench	25/50

Strainer Wrench



- Plated steel
- For use on basket strainers and tub drains with cross bars
- Long handle for leverage

PART NO.	DESCRIPTION	CTN/MSTR
J40028	Strainer wrench	20/60

Plumb Easy Sink Strainer Wrench



- Fits most basket strainers
- Installs and removes basket strainers with ease

PART NO.	DESCRIPTION	CTN/MSTR
J40128	Plumb Easy sink strainer wrench	4/32

Do All Plumbers Wrench



- Longer, more comfortable handle allows greater leverage for tightening or loosening locknuts
- Fits most standard size basket strainers including: Opella, Duo, Twist Lock and PB Duo. Use on any strainer which uses a standard 3-3/8" locknut
- Fits most shower stall drains
- Fits the following drain styles:
 - 2" Plastic No Caulk for plastic pipe
 - 2" Brass No Caulk for plastic pipe
 - 2" Receptor Base for plastic pipe
 - 2" Drop In style for plastic pipe
- Carded

PART NO.	DESCRIPTION	CTN/MSTR
J40019	Do All plumbers wrench	10/40

Heavy Duty Pipe Wrench



- Manufactured to U.S. Specification GGG-W651 Type II Class A
- Upper and lower jaws forged and tempered
- Nodular cast iron handle



PART NO.	LENGTH	CAPACITY	ROTHENBERGER	CTN/MSTR
J40065	8"	1"	70150	1/6
J40066	10"	1-1/2"	70151	1/6
J40067	12"	2"	70152	1/6
J40068	14"	2"	70153	1/4
J40069	18"	2-1/2"	70154	1/2
J40070	24"	3"	70155	1/4
J40105	36"	5"	70156	1/4

Aluminum Pipe Wrench



- Manufactured to U.S. Specification GGG-W651 Type I Class B
- Forged and tempered handle, bottom jaw and nut
- Alloy handle



PART NO.	LENGTH	CAPACITY	ROTHENBERGER	CTN/MSTR
J40071	10"	1-1/2"	70159	1/4
J40072	14"	2"	70160	1/6
J40073	18"	2-1/2"	70161	1/6
J40074	24"	3"	70162	1/6
J40106	36"	5"	70163	1/4

Adjustable Wrench



- Manufactured to Federal Specification GGG-W-631-B Type I Class I
- Drop forged
- Chrome plated



PART NO.	LENGTH	CAPACITY	CHANNEL LOCK	CTN/MSTR
J40075	6"	13/16"	806W	1/5
J40076	8"	15/16"	808W	1/5
J40077	10"	1-3/16"	810W	1/5
J40078	12"	1-3/8"	812W	1/5
J40079	15"	1-3/8"	815	1/1

Curb Box Wrench



- For pentagon curb boxes
- Thin wall socket fits most boxes

PART NO.	DESCRIPTION	CTN/MSTR
M25900	Curb box wrench	1/100

Box Wrench



- For B and MC tanks

PART NO.	DESCRIPTION	CTN/MSTR
J40230	Box wrench	1/1

Bibb Seat Tool Set



- Set includes:
 - 3/8" x 7/16" ratcheting box wrench
 - Small hex/large hex tapered bibb seat tool
 - Small square/large square tapered bibb seat tool
 - Small square/large square straight bibb seat tool
 - Sleeved pouch

PART NO.	DESCRIPTION	CTN/MSTR
J40308	Bibb seat tool set	20/40

Strap Wrench



- For chrome fittings and nipples

PART NO.	DESCRIPTION	CTN/MSTR
J40307	7" strap wrench	25/50
J40311	11" strap wrench	12/24

Twist-Off Strap Wrench



- Grips when wet
- Will not scratch
- High density polyethylene handle
- Heavy duty rubber strap
- Carded

PART NO.	DESCRIPTION	CTN/MSTR
J40325	Twist-off strap wrench	15/60

Hydrostatic Pressure Pump



- Maximum pressure 700 PSI
- 1/2" NPT hose connection
- Three gallon tank capacity



PART NO.	DESCRIPTION	ROTHENBERGER	CTN/MSTR
J40223	Complete pressure pump unit	6.1004	1/1
J40224	0 - 700 PSI gauge	6.1313	1/1
J40225	Piston	6.1300	1/1

RP 30 Hydrostatic Test Pump



- For quick pressure testing and/or air tight testing
- Ideal for use in small spaces
- Steel reinforced test hose
- Test up to 440 lbs
- 500 PSI
- No false reading from any bulging of the hose!



PART NO.	DESCRIPTION	ROTHENBERGER	CTN/MSTR
J40123	Hydrostatic test pump	RP 30	1/1

High Pressure Hose with Fitting



- For hydrostatic pressure pump

PART NO.	DESCRIPTION	CTN/MSTR
J40198	High pressure hose with fitting	1/1

Air Pump



- Large diameter
- Heavy metal construction
- Pressure gauge included

PART NO.	DESCRIPTION	CTN/MSTR
P10001	Heavy duty pump	1/10

Economy Air Pump



PART NO.	DESCRIPTION	CTN/MSTR
P10002	1-1/2" x 18" air pump	1/12

Water Pump



- Excellent for draining water meter boxes
- High impact PVC; non-sparking; lightweight
- No priming necessary- removes 35 ounce/stroke
- Remove foot valve to clean

PART NO.	DESCRIPTION	CTN/MSTR
P13600	36" pump with 72" discharge hose	1/1

4-N-1 Copper Tube Fitting Brush



- Includes four long lasting high carbon steel brushes for 1-1/2" and 3/4" copper tube and fittings

PART NO.	DESCRIPTION	CTN/MSTR
B10004	Copper tube and fitting brush	1/10

Female Copper Tube Brush



- For cleaning copper tubing
- CARTON QUANTITIES ONLY

PART NO.	DESCRIPTION	CTN/MSTR
B29625	CTS OD 5/8" copper tube brush	6/6
B29875	CTS OD 7/8" copper tube brush	6/6
B29999	CTS OD 1-1/8" copper tube brush	6/6

Copper Fitting Brush



- Carbon steel
- CARTON QUANTITIES ONLY

Wire Handle

Wooden Handle

Wire Handle			
PART NO.	ID	OD	CTN/MSTR
B28025	1/4"	3/8"	12/72
B28375	3/8"	1/2"	12/72
B28050	1/2"	5/8"	12/72
B28051	1/2"	5/8"	100/100
B28075	3/4"	7/8"	12/72
B28076	3/4"	7/8"	100/100
B28100	1"	1-1/8"	12/72
B28125	1-1/4"	1-3/8"	6/36
B28150	1-1/2"	1-5/8"	12/72
B28200	2"	2-1/8"	6/36
Wooden Handle			
PART NO.	ID	OD	CTN/MSTR
B29025	1/4"	3/8"	12/72
B29375	3/8"	1/2"	12/72
B29050	1/2"	5/8"	12/72
B29051	1/2"	5/8"	100/100
B29075	3/4"	7/8"	12/72
B29076	3/4"	7/8"	100/100
B29100	1"	1-1/8"	12/72
B29125	1-1/4"	1-3/8"	6/36
B29150	1-1/2"	1-5/8"	6/36
B29200	2"	2-1/8"	6/36

Socket Savers



- Removes Schedule 40 plastic pipe from a hub
- Cuts ABS or PVC DWV pipe below slab
- Fits 1/2" variable speed power drill
- Carded

PART NO.	DESCRIPTION	CTN/MSTR
J44050	1/2" Socket Saver	36/144
J44075	3/4" Socket Saver	30/120
J44100	1" Socket Saver	24/96
J44150	1-1/2" Socket Saver	24/96
J44200	2" Socket Saver	12/72
J44300	3" Socket Saver	12/48
J44400	4" Socket Saver	20/40

Items marked with the Jones Stephens logo are "You Need It... We Got It" Items.

Inside Pipe Cutter



- Cuts 2" and larger plastic pipe
- Fits electric drill

PART NO.	DESCRIPTION	CTN/MSTR
P70023	3" shaft with 2 blades	1/50
P70029	(3) replacement blades	1/10

EZY Grind Pipe Cutter



- Made from tool steel
- Replaceable diamond blade
- Suitable for portable power drills
- 1/4" hex shank, fits all drill chucks
- Guided cutting motion
- Pre-set depth of cut
- Cuts PVC and ABS pipe
- A fast and safe way to cut pipes at or below floor level

PART NO.	DESCRIPTION	CTN/MSTR
J40650	Pipe cutter for 3"- 4" plastic DWV pipe	1/1
J40652	Replacement blade for 3"- 4" pipe cutter (2 pack)	1/1
J40651	Pipe cutter for 1-1/2" - 2" plastic DWV pipe	1/1
J40653	Replacement blade for 1-1/2" - 2" pipe cutter (2 pack)	1/1

E-Z Shear Inside Pipe Cutter



- Cuts PVC and ABS pipe
- High speed steel blade with zinc-plated shaft

PART NO.	DESCRIPTION	CTN/MSTR
J40830	E-Z shear inside pipe cutter	24/192
J40831	(2) E-Z shear replacement blades	1/100

PVC Pipe Cutter



- High carbon steel blades
- Repair kits includes all screws and springs needed to repair cutter
- Aluminum alloy handles
- Ratchet action
- P70001 is carded

PART NO.	DESCRIPTION	CTN/MSTR
P70001	1" pipe cutter	10/50
P70005	Replacement blade	50/300
P70015	1" repair kit	1/100

Heavy Duty PVC Pipe Cutter



- High carbon steel blades
- Repair kit includes all screws and springs needed to repair cutter
- Aluminum alloy handles

PART NO.	DESCRIPTION	CTN/MSTR
P70010	1" heavy duty pipe cutter (boxed)	1/60
P70011	1" heavy duty replacement blade	1/100
P70012	1" repair kit	1/100
P70002	2" pipe cutter (boxed)	1/20
P70006	2" replacement blade	1/100
P70016	2" repair kit	1/100

PVC One-Handed Pipe Cutter



- Easy one-handed ratchet cutting action
- Spring loaded blade
- Heat treated hardened steel blade for straighter cuts - longer life
- Contractor quality - great for plumbers, pool contractors, electricians, etc.
- Cuts up to 2" pipe (2-1/2" OD)
- P70035 is carded

PART NO.	DESCRIPTION	CTN/MSTR
P70035	2" PVC one-handed pipe cutter	6/24
P70036	Replacement blade	25/50

Professional PVC Pipe Cutter



- Rustproof
- Capacity to 1-1/4" diameter PVC
- The blade is non-electro nickel plated which ensures a sharper blade
- Locking hook can be used to deburr pipe
- P70018 and P70019 are carded

PART NO.	DESCRIPTION	CTN/MSTR
P70018	1-1/4" PVC pipe cutter	5/30
P70019	Replacement blade	10/100
P70020	Repair kit (spring and screws)	10/100

Vinyl Tubing Cutter



- Plastic body
- Cuts up to 1" vinyl tubing

PART NO.	DESCRIPTION	CTN/MSTR
P70030	Vinyl tube cutter	12/72
P70031	Replacement blade	50/500

Telescopic Tubing Cutter



- Extra wheel in handle
- Grooved roller
- 1/4"- 1-1/4" cutter
- Imported
- Built-in deburring tool

PART NO.	DESCRIPTION	CTN/MSTR
P70050	Telescopic tubing cutter	10/100
P70055	Replacement cutter wheel	1/100
P70056	(2) Replacement cutter wheels	50/500

Telescoping Tubing Cutter



- Enclosed feed mechanism
- Grooved rollers for close-to-flare cuts
- Anodized body for corrosion resistance
- Allows cut with shorter arc
- Fold-away reamer
- Spare cutter wheel stored in body



PART NO.	DESCRIPTION	ROTHENBERGER	CTN/MSTR
J40240	1/8" - 1-1/8" O.D. capacity	70010	1/1
J40241	1/4" - 1-5/8" O.D. capacity	70011	1/1
J40242	Replacement cutter wheel	70007	1/1
J40243	Cutter wheel pin	51250	1/1
J40244	Cutter wheel pin retaining ring	51240	1/1

Items marked with the Jones Stephens logo are "You Need It... We Got It" Items.

Enclosed Feed Tube Cutter



Retractable
Deburring
Blade

- Extra cutter in knob
- Heavy duty one piece slide
- Polished rollers for easy rotation
- Cuts: copper, brass, aluminum tubing, thin-wall conduit
- P70056 is carded

PART NO.	DESCRIPTION	CTN/MSTR
P70064	1/8" x 1-3/16"	10/60
P70056	(2) Replacement cutter wheels	50/500

Quick Release Tubing Cutter



- Spring-loaded for quick size adjustment
- Spring cutter wheel in handle
- P70069 is carded

PART NO.	DESCRIPTION	CTN/MSTR
P70065	1/4" - 2" O.D. Capacity tubing cutter	6/48
P70069	(2) Replacement cutter wheels	50/500

Quick Release Tubing Cutter



- Spring-loaded ratchet allows for quick size adjustment and release
- Spare cutter wheel in handle



PART NO.	DESCRIPTION	ROTHENBERGER	CTN/MSTR
J40217	1/4" - 2 5/8" heavy duty cutter	7.0030	1/1
J40218	Repl. cutter wheel for metal	7.0005	1/1
J40219	Repl. cutter wheel for plastic	7.0028	1/1
J40228	Cutter wheel screw	7.0006	1/10

Economy Tube Cutter



- Screw-feed
- Zinc plated

PART NO.	DESCRIPTION	CTN/MSTR
P70066	1/8" - 1-1/8"	10/60
P70067	(2) Replacement blades (slide blister)	50/500

Ratcheting Handle Copper Tube Cutter



- Cuts multiple sizes of copper, aluminum tubing, and thin-wall conduit
- Long handle for more leverage

PART NO.	DESCRIPTION	CTN/MSTR
J40262	1/4"-3/4" Ratcheting handle copper tube cutter	6/48

Mini Tubing Cutter



PART NO.	DESCRIPTION	ROTHENBERGER	CTN/MSTR
J40213	5/8" capacity tubing cutter	7.0001	1/24
J40215	Replacement cutter wheel	7.0003	1/1
J40228	Cutter wheel screw	7.0006	6/48

Items marked with the Jones Stephens logo are "You Need It...We Got It" Items.

Mini Tubing Cutter



- Good for all soft metal tubing
- P70052 is carded

PART NO.	DESCRIPTION	CTN/MSTR
P70051	Mini tubing cutter - 1/8"-5/8"	20/200
P70052	Mini tubing cutter-1/8"-7/8" (uses P70056 repl. blade)	1/100
P70053	Mini tubing cutter- 1/8" - 1-1/8"	1/80
P70060	(2) Replacement blades (bulk)	25/250
P70067	(2) Replacement blades (slide blister)	50/500

Copper Tube Cutter



- Self-clamping and self-aligning
- Easy to use in close quarters
- Cuts copper and PVC quickly and easily
- J40260 and J40261 are carded

PART NO.	DESCRIPTION	CTN/MSTR
J40260	1/2" Copper tube cutter	10/100
J40261	3/4" Copper tube cutter	10/60
J40263	(2) Replacement blades for J40260 and J40261	50/500

Plastic Saw



- Die cast aluminum handle
- Quickly cuts PVC, ABS, wood, sheetrock, etc.
- Large comfortable grip
- Flame hardened blade
- Blade has 10 teeth/inch

PART NO.	DESCRIPTION	CTN/MSTR
S49001	18" Saw	1/6
S49002	Replacement blade	50/100
S49010	Handle only	20/100

Drywall Saw



- High quality carbon steel blade
- Great for sheetrock, wallboard, gypsum, plywood, wood and plastic pipe
- 6" 8 TPI aggressive tooth design ensures super sharp, fast and easy cut
- Comfortable grip with thumb stop for greater leverage

PART NO.	DESCRIPTION	CTN/MSTR
S49012	Drywall saw	1/10
S49013	Replacement blade	1/300

Hardwood 250 Speed Handsaw



- Great for hardwood and laminated wood
- Tri-edge and impulse hardened teeth for accurate rip, cross and slant cuts

PART NO.	DESCRIPTION	CTN/MSTR
S49200	Hardwood 250 speed handsaw	10/60
S49201	Replacement blade	50/100

Cable Saw

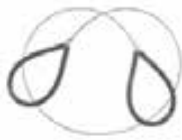

- For cutting PVC pipe
- For tight spots offering little clearance
- Fits easily into tool box and pocket
- Faster and easier than hacksaws in close quarters
- Individually bagged with header card

PART NO.	DESCRIPTION	CTN/MSTR
S49136	36" cable saw display - 36 pieces	1/1
S49148	48" cable saw display - 24 pieces	1/1
S49036	36" cable saw	1/36
S49048	48" cable saw	1/24

T-Handle Cable Saw



- For cutting PVC pipe
- Strong and comfortable t-handles
- Great for use in tight spots
- Long-lasting stainless steel cutting cable
- Polybagged with header card

PART NO.	DESCRIPTION	CTN/MSTR
S49236	36" cable saw	1/100

Close Quarters Hacksaw



- Nickel plated steel frame
- Cuts wood, plastic, brass, aluminum and steel

PART NO.	DESCRIPTION	CTN/MSTR
S50060	6" close quarters hacksaw	1/50
S50061	(5) Replacement blades for S50060	5/800
S50062	6" adjustable hacksaw	12/144
S50063	(5) Replacement blades for S50062	5/1000

Hacksaw



- Heavy square tubing and die cast construction
- Stores extra blades
- Blade tensioning adjustment
- Cuts flush with surface

PART NO.	DESCRIPTION	CTN/MSTR
S49003	Hacksaw with blade	6/36

Snap Knife



- 8 point snap-off blade
- Counter display box has 30 pcs.
- 10 per tube, priced each
- CARTON QUANTITIES ONLY

PART NO.	DESCRIPTION	CTN/MSTR
K50001	Snap knives display box	30/300
K50002	8 point snap knife	40/480
K50003	8 point replacement blade	10/200

Deluxe Autolock Snap Knife



- Blade automatically locks into position
- Contoured shape for a more comfortable grip

PART NO.	DESCRIPTION	CTN/MSTR
K50005	Deluxe autolock snap knife	20/200

Utility Knife



- Heavy duty construction
- Supplied with extra blade
- Coated case

PART NO.	DESCRIPTION	CTN/MSTR
K50041	Utility knife	12/120
K50042	(5) Replacement blades	100/1000

Heavy Duty Utility Knife - Carded



- Safety orange color
- Solid east metal
- Retractable
- Blade included
- Carded

PART NO.	DESCRIPTION	CTN/MSTR
K50046	Heavy duty utility knife	12/144
K50043	Utility knife replacement blades with dispenser (100/pk)	6/36

Got To Have It!

E-Z Stroke Pipe Saw

- Orange handle
- For smooth, fast, accurate cutting
- Tri-edge teeth are borazon wheel ground
- Pull-stroke cutting action
- Cuts plastic pipe and wood
- Replaceable blade



PART NO.	DESCRIPTION	CTN/MSTR
S49005	8" E-Z stroke pipe saw	10/100
S49006	8" Replacement blade	50/250
S49008	12" E-Z stroke pipe saw	10/100
S49007	12" Replacement blade	50/200



Items marked with the Jones Stephens logo are "You Need It...We Got It" Items.

Fiberglass Handle Shovel



- STINGER SERIES - Fiberglass handle is 40% stronger than Federal Strength Test for long handle wood tools.
- Large steel collar adds maximum strength to handle/socket connection.
- Forward - turned step for secure foot placement

PART NO.	DESCRIPTION	AMES #	CTN/MSTR
S49412	Long handle square point	SFGLS	1/6
S49416	D-Handle 16" drain spade	SFGD16	1/6
S49413	Long handle 16" drain spade	SFGDSL	1/6

Premium Grade Wood Handle Shovel

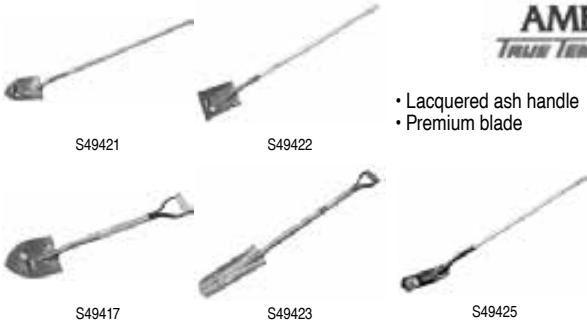

- Lacquered ash handle
- Premium blade

PART NO.	DESCRIPTION	AMES #	CTN/MSTR
S49421	Long handle round point	BMTLR	1/6
S49422	Long handle square point	BMTLS	1/6
S49417	D-Handle round point	BMTDR	1/6
S49423	D-Handle 16" drain spade	15-738	1/6
S49425	LH trenching shovel 4" blade	15-566	1/6
S49427	LH trenching shovel 5" blade	15-567	1/6

Economy Grade Wood Handle Shovel



PART NO.	DESCRIPTION	AMES #	CTN/MSTR
S49431	Long handle round point	15-047	1/6
S49432	Long handle square point	15-049	1/6

Economy Grade Wood Handle Shovel

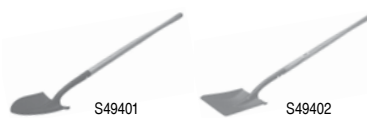

PART NO.	DESCRIPTION	CTN/MSTR
S49401	Long handle round point	1/6
S49402	Long handle square point	1/6

Specialty Shovel



- KODIAK CUB - smaller design for easier use in tight spaces
- 16 gauge tempered steel blade
- Forward turned step
- 27" overall length

PART NO.	DESCRIPTION	AMES #	CTN/MSTR
S49429	Compact utility shovel	15-663	1/6

Long Handle Round Point Fiberglass Shovel



- Long fiberglass handle
- Round point

PART NO.	DESCRIPTION	CTN/MSTR
S49400	Long handle round point	1/12

Combination Snow Pusher/Shovel



- 18" x 14" poly blade
- Deep rib molded, non-stick poly blade
- Heavy duty

PART NO.	DESCRIPTION	CTN/MSTR
S49430	Combination snow pusher/shovel	1/6

Poly Blade Snow Shovel



- 21" deep rib molded, non-stick poly blade
- High impact blade
- Lightweight
- 48" heavy duty handle

PART NO.	DESCRIPTION	CTN/MSTR
S49434	Poly blade snow shovel	1/6

D-Grip Poly Blade Snow Shovel



- 18" x 14" high-impact, non-stick poly blade
- Lightweight
- 48" heavy duty handle

PART NO.	DESCRIPTION	CTN/MSTR
S49433	D-grip poly blade snow shovel	1/6

44" Telescopic Snow Brush



- Great for trucks and SUV's!
- Combination snow brush, scraper, and squeegee
- Extra thick bristles
- Aluminum handle

PART NO.	DESCRIPTION	CTN/MSTR
S80201	44" telescopic snow brush	1/24

12" Cushion Grip Snow Scraper



- Display box included
- 24 scrapers; priced each
- High impact plastic
- Wide scraping surface
- CARTON QUANTITIES ONLY

PART NO.	DESCRIPTION	CTN/MSTR
S80200	12" cushion grip snow scraper display	1/24

Pointing Trowel with Wood Handle



- Fine grained hardwood handle

PART NO.	DESCRIPTION	CTN/MSTR
B29500	5" pointing trowel with wood handle	12/120
B29501	7" pointing trowel with wood handle	12/72

Short Nose Caulking Tool



- For finishing lead joint

PART NO.	DESCRIPTION	CTN/MSTR
J41008	5/8" wide x 7-1/2" long	1/24

Inside Caulking Tool

G



- For finishing lead joint

PART NO.	DESCRIPTION	CTN/MSTR
J41009	5/8" wide x 7" long	1/24

Outside Caulking Tool



- For finishing lead joint

PART NO.	DESCRIPTION	CTN/MSTR
J41010	5/8" wide x 7" long	1/24

Broad Curve Nose Caulking Tool



- Used for packing Oakum tight
- For first pass on lead

PART NO.	DESCRIPTION	CTN/MSTR
J41011	5/8" wide x 8" x 1-1/2"	1/24

17 Pound Digging/Tamping Bar



- For digging holes, cutting roots or tamping

PART NO.	DESCRIPTION	CTN/MSTR
S49500	1" x 69" post hole digger	1/1

Slim Bar 360 Nail Puller



- 14" long
- Hang tab included

PART NO.	DESCRIPTION	CTN/MSTR
J40400	Slim bar 360 nail puller	6/36

Utility Pry Bar



PART NO.	DESCRIPTION	CTN/MSTR
S49489	14" utility pry bar	1/5

Manhole Cover Lifter



- 25" long



PART NO.	DESCRIPTION	CTN/MSTR
S49490	Manhole cover lifter	1/10

Gooseneck Wrecking Bar



- Painted and polished
- Claw on end removes nails

PART NO.	DESCRIPTION	CTN/MSTR
S49501	30" wrecking bar	1/10

Striking Tools



- Hickory handles
- Long life - high quality
- Made in the USA



PART NO.	DESCRIPTION	CTN/MSTR
J40144	3 lb. engineers hammer	1/2
J40142	6 lb. sledgehammer	1/3
J40143	8 lb. sledgehammer	1/3

Pick Mattock



- Hardwood handle
- 5 pound head



PART NO.	DESCRIPTION	CTN/MSTR
J40141	5 lb. pick mattock with handle	1/4

Probing Rod



- Weather resistant fiberglass
- Eliminates danger of shock
- Tip is not replaceable

PART NO.	DESCRIPTION	CTN/MSTR
P27048	4' probing rod	1/5

Steel Probing Rod



- Stainless steel tips
- Cushion vinyl handle
- Welded steel construction

PART NO.	DESCRIPTION	CTN/MSTR
P27004	4' steel probing rod	1/5
P27005	5' steel probing rod	1/5
P27001	Stainless steel tip	1/5

Steel Probing Rod with Ball Point



Ballpoint Tip

- Steel shaft
- Vinyl handle for comfort
- Carbon steel ballpoint will not puncture soft pipe
- Tip is not replaceable

PART NO.	DESCRIPTION	CTN/MSTR
P27003	3' metal probing rod	1/1
P27040	4' metal probing rod	1/1

Water Meter Key



- Rebar shaft and handle for greater strength
- Vinyl covered handle comfort
- Diameter x Length

PART NO.	DESCRIPTION	CTN/MSTR
M25127	1/2" x 27" meter key	1/5
M25136	1/2" x 36" meter key	1/5
M25148	1/2" x 48" meter key	1/5
M25527	5/8" x 27" meter key	1/5
M25536	5/8" x 36" meter key	1/5
M25560	5/8" x 60" meter key	1/5
M25736	3/4" x 36" meter key	1/5
M25760	3/4" x 60" meter key	1/5
M25772	3/4" x 72" meter key	1/5
M25784	3/4" x 84" meter key	1/5

Combo Water Meter Key



- Rebar shaft and handle for greater strength
- Vinyl covered handle comfort
- Combo lid key and meter key
- Diameter x Length

PART NO.	DESCRIPTION	CTN/MSTR
M25130	1/2" x 30" meter key	1/5

Items marked with the Jones Stephens logo are "You Need It...We Got It" Items.

Gate Valve Key



PART NO.	DESCRIPTION	CTN/MSTR
M25100	30" gate valve key	1/5

Copper Sizing Tool



- For type "M" copper tubing
- Impact type to reround tube

PART NO.	DESCRIPTION	CTN/MSTR
J40750	1/2" copper sizing tool	10/60
J40775	3/4" copper sizing tool	10/40
J40800	1" copper sizing tool	10/30

Copper Swedge Tool



J40375

J40369

- Use J40375 on 1/4", 5/16", 3/8", 1/2", and 5/8" copper tube
- Use J40369 on 5/8", 7/8", and 1 1/8" copper tube
- Heat-treated carbon steel
- Can also be used on soft copper, aluminum or any other thin-walled tubing

PART NO.	DESCRIPTION	CTN/MSTR
J40375	copper swedge tool	25/100
J40369	copper swedge tool (up to 1 1/8")	12/24

Polybutylene Crimping Tools



- Single crimp and combo tools
- Accurate and easy to use
- Unit can be calibrated in the field
- Made in the USA

MADE IN THE USA

PART NO.	DESCRIPTION	CTN/MSTR
J42002	1/2" regular crimping tool	1/10
J42003	3/4" regular crimping tool	1/10
J42004	1/2" - 3/4" combo crimping tool	1/10

Note: These tools cannot be returned for repair.

Oetiker® 3-Handle Ratcheting Crimp Tool



- Tool will not release until clamp is properly closed
- Robust fastener with assist lever
- Single handed installation possible
- Made in the USA

MADE IN THE USA

PART NO.	DESCRIPTION	CTN/MSTR
J40967	3" hand crimp tool	1/1

Pex Crimp Set



- For use on crimping PEX pipe with copper crimp rings and stainless steel bands

PART NO.	DESCRIPTION	CTN/MSTR
J40950	PEX crimp set with 3/8", 1/2", 3/4" heads	1/1
J40951	3/8" PEX crimp tool	1/1
J40952	1/2" PEX crimp tool	1/1
J40953	3/4" PEX crimp tool	1/1
J40954	1" PEX crimp tool	1/1
J40955	PEX crimp sizing tool	1/1
J40960	PEX crimp ring cutter	1/1
J40965	One hand PEX SS clamp tool	1/1
J40966	PEX SS clamp tool	1/1

Flaring Tool



- Makes smooth flare
- For O.D. sizes 3/16", 1/4", 5/16", 3/8", 1/2" and 5/8"

PART NO.	DESCRIPTION	CTN/MSTR
J40080	Bar flaring tool	6/24

Swing Release Flaring Tool



- 3/16" - 5/8" O.D.
- 45° single flare

PART NO.	DESCRIPTION	CTN/MSTR
J40220	45° flaring tool	1/12

Deburring Tool



- Easily removes burrs inside and outside of copper and plastic
- Handle stores spare blades

PART NO.	DESCRIPTION	CTN/MSTR
J40221	Deburring tool with blade	40/180
J40222	Replacement blade	1/1

Nipple Extractor Set



PART NO.	DESCRIPTION	CTN/MSTR
J40054	Nipple extractor set - 3/8", 1/2", 3/4"	20/40
J40055	Nipple extractor set - 3/8", 1/2", 3/4", 1"	1/1

Internal Pipe Nipple Extractor



- Heat treated and cad plated
- Removes nipples

PART NO.	DESCRIPTION	CTN/MSTR
J40050	3/8" nipple extractor	100/200
J40051	1/2" nipple extractor	20/120
J40052	3/4" nipple extractor	50/100
J40053	1" nipple extractor	25/50

Nipple and Screw Extractor



- Left hand spiral
- Removes nipples, bolts, and screws without thread damage

PART NO.	PIPE SIZE	DRILL SIZE	BOLT SIZE	CTN/MSTR
J41103	1/8"	1/4"	9/32" - 3/8"	1/1
J41104	1/4"	19/64"	3/8" - 5/8"	1/1
J41105	3/8"	13/32"	5/8" - 7/8"	1/1
J41106	1/2"	17/32"	7/8" - 1-1/8"	1/1
J41107	3/4"	13/16"	1-1/8" - 1-3/8"	1/1
J41108	1"	1-1/16"	1-3/8" - 2"	1/1

Carbide Tipped Masonry Drill Bit



PART NO.	REGULAR LENGTHS	SHANK SIZE	CTN/MSTR
S41349	5/32" x 4"	3/16"	1/1
S41351	3/16" x 4"	3/16"	1/1
S41350	1/4" x 4"	1/4"	1/1
S41352	5/16" x 4"	1/4"	1/1
S41353	3/8" x 6"	1/4"	1/1
S41355	1/2" x 6"	3/8"	1/1
S41356	9/16" x 6"	1/2"	1/1
S41357	5/8" x 6"	1/2"	1/1

Masonry Drill Bit



- Carded

PART NO.	DESCRIPTION	CTN/MSTR
S41348	1/8" masonry drill bit	6/48
S41364	3/16" masonry drill bit	6/48
S41450	1/4" masonry drill bit	6/48
S41452	5/16" masonry drill bit	6/48
S41453	3/8" masonry drill bit	6/48
S41455	1/2" masonry drill bit	6/48

Dual Auger Wood Drill Bit



- Screw point
- Up to 1" for use in 3/8" or 1/2" power drill; 1" and up for use in 1/2"

PART NO.	DESCRIPTION	CTN/MSTR
B21625	5/8" x 6" long	1/1
B21075	3/4" x 6" long	1/1
B21087	7/8" x 6" long	1/1
B21100	1" x 6" long	1/1
B21112	1-1/8" x 6" long	1/1
B21125	1-1/4" x 6" long	1/1
B21150	1-1/2" x 6" long	1/1

Flat "Paddle" Wood Drill Bit



PART NO.	DESCRIPTION	CTN/MSTR
B24375	3/8" flat paddle wood bit	1/1
B24050	1/2" flat paddle wood bit	1/1
B24056	9/16" flat paddle wood bit	1/1
B24063	5/8" flat paddle wood bit	1/1
B24075	3/4" flat paddle wood bit	1/1
B24081	13/16" flat paddle wood bit	1/1
B24088	7/8" flat paddle wood bit	1/1
B24100	1" flat paddle wood bit	1/1
B24113	1-1/8" flat paddle wood bit	1/1
B24125	1-1/4" flat paddle wood bit	1/1
B24150	1-1/2" flat paddle wood bit	1/1

Wood Spade Drill Bit



- Carded

PART NO.	DESCRIPTION	CTN/MSTR
B24250	1/2" wood spade drill bit	6/48
B24263	5/8" wood spade drill bit	6/48
B24175	3/4" wood spade drill bit	6/48
B24188	7/8" wood spade drill bit	6/144
B24200	1" wood spade drill bit	6/48
B24213	1-1/8" wood spade drill bit	6/48
B24225	1-1/4" wood spade drill bit	6/48
B24251	1-1/2" wood spade drill bit	6/48

Straight Shank Drill Bit



- High speed steel
- Jobber's length

PART NO.	DESCRIPTION	CTN/MSTR
B20062	1/16" drill	1/1
B20078	5/64" drill	1/1
B20094	3/32" drill	1/1
B20109	7/64" drill	1/1
B20125	1/8" drill	1/1
B20141	9/64" drill	1/1
B20156	5/32" drill	1/1
B20172	11/64" drill	1/1
B20188	3/16" drill	1/1
B20203	13/64" drill	1/1
B20219	7/32" drill	1/1
B20234	15/64" drill	1/1
B20250	1/4" drill	1/1
B20266	17/64" drill	1/1
B20281	9/32" drill	1/1
B20297	19/64" drill	1/1
B20313	5/16" drill	1/1
B20328	21/64" drill (1/8" pipe tap)	1/1
B20344	11/32" drill	1/1
B20359	23/64" drill	1/1
B20375	3/8" drill	1/1
B20391	25/64" drill	1/1
B20406	13/32" drill	1/1
B20422	27/64" drill	1/1
B20438	7/16" drill (1/4" pipe tap)	1/1
B20453	29/64" drill	1/1
B20469	15/32" drill	1/1
B20484	31/64" drill	1/1
B20500	1/2" drill	1/1

G

Pipe Tap



- NPT
- High carbon steel

PART NO.	DESCRIPTION	CTN/MSTR
T41001	1/8" NPT pipe tap	1/1
T41002	1/4" NPT pipe tap	1/1
T41003	3/8" NPT pipe tap	1/1
T41004	1/2" NPT pipe tap	1/1
T41005	3/4" NPT pipe tap	1/1
T41006	1" NPT pipe tap	1/1
T41009	1-1/4" NPT pipe tap	1/1
T41007	1-1/2" NPT pipe tap	1/1
T41008	2" NPT pipe tap	1/1

Locking Measuring Tape



- 33 ft.
- Extra heavy duty rubber case
- Power locking

PART NO.	DESCRIPTION	CTN/MSTR
J40084	1-1/4" x 33' tape measure	1/15

PlumbRule Measuring Tape



- 1" locking blade with push button lock
- Offset fractions for easy reading
- Auto recoil; belt clip and wrist strap
- Red stud markings and joist markings

PART NO.	DESCRIPTION	CTN/MSTR
J40101	1" x 25' tape	6/48

Neon Precision Measuring Tape



- Sure grip case

PART NO.	DESCRIPTION	CTN/MSTR
J40086	1" x 25' neon orange tape	6/48
J40087	1" x 25' neon yellow tape	6/48

Long Measuring Tape



- Hook blade
- Pop-open handle

Starrett

PART NO.	DESCRIPTION	CTN/MSTR
J40088	3/8" x 50' tape	6/36
J40089	3/8" x 100' tape	6/24

Locking Measuring Tape



- Unbreakable chrome plated case
- Power return
- Double riveted tang
- Cushion stop
- Positive lock
- Yellow tape
- Carded

PART NO.	DESCRIPTION	CTN/MSTR
J40046	1" x 25' tape	6/48
J40045	3/4" x 16' tape	12/144

Power Locking Measuring Tape



- Positive thumb lock
- Chrome plated case
- Smooth power return
- Stainless belt clip
- True zero blade hook
- P.R. approved

PART NO.	DESCRIPTION	CTN/MSTR
J40346	1" x 25' tape	6/36
J40345	3/4" x 16' tape	6/36

Brass Plumb Bob



- Solid brass
- Removable tip

PART NO.	DESCRIPTION	CTN/MSTR
J42008	8 oz. brass plumb bob	10/80
J42012	12 oz. brass plumb bob	1/50

Blue Chalk Line Set



- Metal body reel
- 4 oz. chalk
- Carded

PART NO.	DESCRIPTION	CTN/MSTR
J40124	100' blue chalk line set	6/36

Nylon Line Reel



- Twisted nylon
- Carded

PART NO.	DESCRIPTION	CTN/MSTR
J40125	#18 x 270' nylon line reel	6/36

Soap Stone and Holder



- ROUND- Pen size lightweight aluminum holder with built-in chuck
- FLAT- Stainless steel spring tension with locknut
- J40062 and J40063 sold in CARTON QUANTITIES ONLY

PART NO.	DESCRIPTION	CTN/MSTR
J40060	Round soap stone holder	1/6
J40061	Flat soap stone holder	1/6
J40062	Round soap stone	144/box
J40063	Flat soap stone	144/box

Flint Striker



- Round file style
- Renewable flint
- Flints priced per pack of 5 renewals

PART NO.	DESCRIPTION	CTN/MSTR
J40048	Striker	25/200
J40049	(5) flint renewals	50/200

Three Flint Friction Lighter



- Flints priced per pack of 4 renewals
- CARTON QUANTITIES ONLY

PART NO.	DESCRIPTION	CTN/MSTR
J40047	Three flint friction lighter	6/48
J40044	Flint renewal unit (4/card)	1/1

MAPP and Propane Cylinders



- Temperatures for burning: Propane 2300°, MAPP 3300°
- LTL TRANSPORTATION ONLY
- NO UPS/FED EX
- CARTON QUANTITIES ONLY

PART NO.	DESCRIPTION	CTN/MSTR
J40601	14.1 oz. Propane	12/12
J40600	14.1 oz. MAPP	12/12

Solid Brass Pencil Torch for Propane Only



- Use with Propane Gas. Rates to 3,452°F (1,800°C)
- Oversize flame adjustment knob
- For soldering copper pipes, loosening rusty nuts and bolts, thawing frozen metal pipes, lighting charcoal
- CSA approved

PART NO.	DESCRIPTION	CTN/MSTR
J40430	Solid brass pencil torch for propane only	6/48

Self Igniting Torch for Propane Only



- Use with Propane Gas. Rates to 3,452°F (1,800°C)
- Piezo igniter for instant flame
- Oversize flame adjustment knob
- For soldering copper pipes, loosening rusty nuts and bolts, thawing frozen metal pipes, lighting charcoal
- Brass body, plastic housing, stainless steel tip
- CSA approved

PART NO.	DESCRIPTION	CTN/MSTR
J40431	Self igniting torch for propane only	6/48

Self Igniting Hand Torch for MAPP or Propane



- Heavy duty
- For MAPP or propane
- Use with either Propane or MAPP Gas
- Cyclone flame pattern for concentrated high heat
- Piezo igniter for instant flame
- Adjustable knob for variable flame patterns
- Safety lock feature to prevent accidental ignition
- Ignition lock for continuous use
- Cast body for durability, strength and long life
- Ergonomic handle design
- Stainless steel nozzle with brass tip

PART NO.	DESCRIPTION	CTN/MSTR
J40432	Self igniting hand torch for MAPP or propane	4/24
J40529	Hand torch with swivel tip and self-igniter	1/20
J40329	Replacement tip for J40529	1/1
J40629	Hand torch with swivel tip	1/20
J40429	Replacement tip for J40629	1/1
J40229	Pencil flame torch	1/1

Solder Shield Protective Blanket



- For use when combustible material is present during soldering
- 9" x 12" protection area
- Protects up to 2300°F for five minutes
- Smoke and odor free non-asbestos material
- Lends a clean, professional appearance to your work
- Durable woven ceramic holds up well in multiple uses

PART NO.	DESCRIPTION	CTN/MSTR
J40812	9" x 12" solder shield	1/1

Flux Paste



- Meets ASTM B813
- Water flushable for faster rinsing from pipe lines
- Super detergent action cleans as it solders
- Non-acid, non-toxic, **lead free**
- Contains no zinc chloride
- Use with all lead-free and common soft solders
- For use on copper, brass, galvanized iron, lead, zinc, tin, silver, nickel, mild steel, terne plate, and malleable iron
- Meets Mil. Spec. Mil-F-4995 Type II



PART NO.	DESCRIPTION	CTN/MSTR
S95102	4 oz. Flux paste	1/48
S95106	4 oz. Flux paste with brush in cap	1/48
S95103	1 lb. Flux paste	1/24

Flux-Rite 90® Flux



- Meets ASTM B-813
- Water soluble for faster flushing from pipe lines
- Super detergent action cleans as it solders
- Non-acid, non-toxic and lead free
- Contains no zinc chloride
- Use with all lead free and common soft solders
- For use on most metal types



PART NO.	DESCRIPTION	CTN/MSTR
S95104	4 oz. Flux-Rite 90® flux	1/24
S95105	1 lb. Flux-Rite 90® flux	1/12

Phos-Copper Brazing Rod



- 92.9% copper/ 7.1% phos
- Tensile strength 91,000 PSI
- Self-fluxing
- Liquid 1460°F, solid 1310°F
- Working temp 1350°-1500°F
- 1 pound plastic tubes

PART NO.	DESCRIPTION	CTN/MSTR
J41021	1 lb. tube brazing rod	1/10

2% Silver Solder



- 91% copper/ 7% phos/ 2% silver
- Liquid 1450°F, solid 1190°F
- Meets AWS A5.8QQB-650 B Cup-6
- 1 pound plastic tubes

PART NO.	DESCRIPTION	CTN/MSTR
J41022	1 lb. tube 2% silver solder	1/10

5% Silver Solder



- 89% copper/ 6% phos/ 5% silver
- Meets AWS A5.8-81-BCup3 Fed QQB650B
- Liquid 1475°F, solid 1190°F
- Working temperature 1300°-1550°F
- 1 pound plastic tubes

PART NO.	DESCRIPTION	CTN/MSTR
J41023	1 lb. 5% silver solder	1/10

15% Silver Solder



- 80% copper/ 5% phos/ 15% silver
- Meets AWS A5.8-81-BC7P3 Fed QQB650B
- Liquid 1495°F, solid 1190°F
- Working temperature 1300°-1500°F
- 1 pound plastic tubes

PART NO.	DESCRIPTION	CTN/MSTR
J41024	1 lb. tube 15% silver solder	1/10

Freeze Fix Pipe Jacket



- Fast, easy way to freeze pipe up to 4"
- Saves time and money on pipe repairs
- Repairs can be made without draining the water out of the line

Quick Way to Freeze Pipes for Easy Repair!

PART NO.	DESCRIPTION	L x W	CTN/MSTR
J40801	3/8" - 3/4" jacket	8" x 4-1/2"	1/1
J40802	3/4" - 1-1/2" jacket	10-1/2" x 7"	1/1
J40803	1-1/2" - 3" jacket	14" x 8-1/2"	1/1
J40804	3" - 4" jacket	16" x 11"	1/1
J40805	8' hose and connectors for CO2 kit	-	1/1
J40806	Tee connector for CO2 freeze kit	-	1/1
J40807	Freeze fix carry bag	-	1/1
J40808	CO2 empty cylinder (20 lb. size)	-	1/1

Files



- Durable plastic handles
- Top quality alloy steel

PART NO.	DESCRIPTION	CTN/MSTR
J41201	8" mil bastard file with handle	1/4
J41202	10" mil bastard file with handle	1/4
J41205	12" half round file	1/4
J41206	14" half round file	1/4

8" Half Round Bastard File



- High speed steel plastic molded handle
- Carded double blister

PART NO.	DESCRIPTION	CTN/MSTR
J41210	8" half round bastard file	6/36

Sure Sweat Dissolvable Pipe Plug

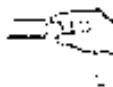

- Stop water from inside the pipe
- Dissolve safely and completely with water

PART NO.	DESCRIPTION	CTN/MSTR
H56050	1/2" kit (7 plugs per box)	1 box of 7/24
H56075	3/4" kit (5 plugs per box)	1 box of 5/24

Slip Jaw Pliers



- Plated finish
- Plastic grips

PART NO.	DESCRIPTION	CTN/MSTR
P60001	2-1/8" capacity / 10" long	1/5

Water Pump Pliers



- Drop forged vanadium steel; black epoxy powder coated
- Cushion grip
- Self-locking on pipe



PART NO.	LENGTH	CAPACITY	ROTHENBERGER	CTN/MSTR
J40210	7"	1"	7.0521	1/6
J40211	10"	1-1/4"	7.0522	1/6
J40212	12"	1-1/2"	7.0523	1/6

Griplock Tongue and Groove Water Pump Pliers



- Comfort grips



PART NO.	LENGTH	NO. ADJ.	CAPACITY	CHANNEL LOCK NO.	CTN/MSTR
J40410	10"	5	1-1/4"	GL10	1/5
J40411	12"	6	2-1/4"	GL12	1/5

"No Pinch" Pipe Wrench Pliers



- 10" comfort cushion grips
- Unique handle design prevents pinched fingers
- 1-3/4" jaw capacity
- Drop forged; plated finish

PART NO.	DESCRIPTION	CTN/MSTR
P60002	10" Pipe wrench pliers	4/40

10" Smooth Jaw Pliers



- 2-1/8" jaw opening
- Smooth jaws for non-arrng surfaces (chrome, polished brass)
- Cushioned vinyl grips

PART NO.	DESCRIPTION	CTN/MSTR
P60003	10" Smooth jaw pliers	10/50

Tongue and Groove Pliers



- Right angle teeth
- Undercut tongue and groove- won't slip
- Comfort grips



PART NO.	LENGTH	NO. ADJ.	CAPACITY	CHANNEL LOCK NO.	CTN/MSTR
J40401	6-1/2"	5	7/8"	426	1/5
J40402	9-1/2"	5	1-1/2"	420	1/5
J40403	10"	7	2"	430	1/5
J40404	12"	7	2-1/4"	440	1/5
J40405	16"	8	4-1/4"	460	1/2

Curved Jaw Tongue and Groove Pliers



- Curved jaw for use on round stock and tubing
- Right angle teeth

CHANNEL LOCK

PART NO.	LENGTH	NO. ADJ.	CAPACITY	CHANNEL LOCK NO.	CTN/MSTR
J40407	9-1/2"	5	1-1/2"	422	1/5
J40408	12"	7	2-1/4"	442	1/5

Smooth Jaw Tongue and Groove Pliers



- Smooth jaws for non-marring surfaces (PVC, chromes, etc.)
- Undercut tongue and groove-won't slip
- Comfort grips

CHANNEL LOCK

PART NO.	LENGTH	NO. ADJ.	CAPACITY	CHANNEL LOCK NO.	CTN/MSTR
J40406	10"	7	2"	415	1/5

4 in 1 Screwdriver



S41001 - 12 pk Display

- Alloy tool steel bits
- Ground and polished
- Heat treated for maximum strength
- High impact handle
- Floating ball bearing for tight fit

PART NO.	DESCRIPTION	CTN/MSTR
S41001	Phillips and slotted display	1/12
S41002	Slotted bit for 4 in 1 or 6 in 1	1/1
S41003	Phillips bit for 4 in 1	1/1

6 in 1 Screwdriver



S41006 - 12 pk Display

- Shaft ends are 1/4" and 15/16" hex size for use as nut drivers
- Each bit has two sizes

PART NO.	DESCRIPTION	CTN/MSTR
S41006	6 in 1 screwdriver display	1/12
S41002	Slotted bit for 4 in 1 or 6 in 1	1/1
S41007	Phillips bit for 6 in 1	1/1

Magnetic Power Nut Setters



- 1/4" hex shaft

PART NO.	DESCRIPTION	CTN/MSTR
S41300	1-3/4" long 1/4" head size	1/1
S41301	1-3/4" long 5/16" head size	1/1
S41302	2-9/16" long 1/4" head size	1/1
S41303	2-9/16" long 5/16" head size	1/1

Nut Driver



PART NO.	DESCRIPTION	CTN/MSTR
S06014	3/16" Nut driver	1/10
S06015	1/4" Nut driver	1/10
S06016	5/16" Nut driver	1/10
S06017	3/8" Nut driver	1/10
S06018	7/16" Nut driver	1/10
S06019	1/2" Nut driver	1/10

Bit Holder



- For insert type bits
- Magnetic

PART NO.	DESCRIPTION	CTN/MSTR
S41307	1/4" drive x 3" long	1/1

Phillips Bit



PART NO.	DESCRIPTION	CTN/MSTR
S41306	#2 point 1/4" hex 1" insert type	1/1
S41308	# 2 point 1/4" hex 11 5/16" long insert type	1/1

100% Silicone Tub and Tile Sealant



J40197
J40199



J40200
J40201

- Ideal for tubs, sinks, toilets, showers and resetting loose tiles
- Warranted to last as long as the fixture
- Contains potent mildewcide
- Application temperature range -10°F to 100°F
- Service temperature range -60°F to 400°F
- CARTON QUANTITIES ONLY



PART NO.	DESCRIPTION	CTN/MSTR
J40199	2.8 oz. tube CLEAR caulk	12/12
J40197	2.8 oz. tube WHITE caulk	12/12
J40200	10.2 oz. tube CLEAR caulk	12/12
J40201	10.2 oz. tube WHITE caulk	12/12

100% Silicone Caulk



- Flexible, easy to use
- 50 year life
- Will not stain or bleed
- Seal, bond or insulate
- CARTON QUANTITIES ONLY

PART NO.	DESCRIPTION	CTN/MSTR
J40208	10.1 oz. tube CLEAR caulk	12/12
J40288	10.1 oz. tube WHITE caulk	12/12

25-Year Siliconized Acrylic Caulk



- Cleans up with water
- Paintable
- Will not stain or bleed
- Application temperature range 40°F to 90°F
- Service temperature range 0°F to 200°F
- CARTON QUANTITIES ONLY



PART NO.	DESCRIPTION	CTN/MSTR
J40202	10.1 oz. tube WHITE caulk	12/12

Acrylic Tub and Tile Caulk



- Long-lasting watertight seal around tubs, showers, and sinks
- Cleans up with water
- Odorless, mildew resistant
- Paintable
- Application temperature range 40°F to 90°F
- Service temperature range 0°F to 200°F
- CARTON QUANTITIES ONLY



PART NO.	DESCRIPTION	CTN/MSTR
J40203	5.5 oz. almond caulk	12/12
J40204	10.1 oz. white caulk	12/12
J40206	5.5 oz. white caulk	12/12

Latex Caulk



- General purpose
- Dries quickly
- Will not stain or bleed
- Paintable
- CARTON QUANTITIES ONLY



PART NO.	DESCRIPTION	CTN/MSTR
J40207	10.1 oz. white caulk	12/12

Hi-Temp 100% Red Silicone Caulk



- 100% silicone
- USDA approved, UL listed, meets NSF 51
- Temperature from 65°F to 650°F
- CARTON QUANTITIES ONLY



PART NO.	DESCRIPTION	CTN/MSTR
J40285	Hi-temp 100% silicone caulk	12/12

Caulking Gun



- 9" barrel
- Drop-in half barrel type
- Painted steel

PART NO.	DESCRIPTION	CTN/MSTR
C35090	Caulking gun	1/10

Stop Flow™ Style Parallel Smooth Hex Rod Caulking Gun



- For standard cartridge
- Perfectly balanced
- Deep milled cut teeth built in spout cutter
- Nozzle clean out tool
- D-ring and wrist strap ladder hook

PART NO.	DESCRIPTION	CTN/MSTR
C35092	Stop Flow™ style with parallel smooth hex rod	1/12

Professional Caulking Gun



- Parallel hex rod frame
- Seal puncture tool
- Thumb release
- E-Z thrust mechanism
- Spout cutter
- Ladder hook

PART NO.	DESCRIPTION	CTN/MSTR
C35091	Parallel hex rod caulking gun	1/12

Firestop 814+ Intumescent Firestopping Sealant



J40286

- Colored red for ease of inspection
- Fulfills residential and commercial firestopping code requirements
- Meets ASTM-E814/UL 1479 test standards
- Resumes integrity for 1 & 2 hour fire rated assemblies

PART NO.	DESCRIPTION	CTN/MSTR
J40286	10.3 oz. tube	1/12

Got To Have It!

Handi-Plug Combination Test Plug and Stub-Out

- Combination test plug and stub-out for drop eared elbow
- No tools required - manual installation allows for no time wasted applying and removing thread tape after each use! Cost-effective, too!
- No thread seal required
- Reusable - long lasting
- Smooth at thread end for easy plastering
- Time and labor savings



PART NO.	DESCRIPTION	CTN/MSTR
H54050	1/2" MIP Handi-Plug	1/25
H54051	Handi-Plug counter display	1/1

Items marked with the Jones Stephens logo are "You Need It... We Got It" Items.

Fire Seal-136 Firestopping Caulk



- Resumes integrity of fireblocks 1 & 2 family construction
- Meets ASTM-E136 test standards
- Fulfills all residential fireblocking code requirements

PART NO.	DESCRIPTION	CTN/MSTR
J40287	10.3 oz. tube	1/12

Handicap



- No tools required - manual installation allows for no time wasted applying and removing thread tape after each use! Cost-effective, too!
- Reusable - long lasting
- Caps and 1/2" male thread for testing

PART NO.	DESCRIPTION	CTN/MSTR
H54100	1/2" FIP Handicap	1/1000

Marking Products



- High-performance industrial marking products
- Permanent paint
- Quick drying



PART NO.	DESCRIPTION	CTN/MSTR
J40330	Red Dura-Ink® 15 marker	12/72
J40331	Black Dura-Ink® 15 marker	12/72
J40332	Black Dura-Ink® 25 marker	12/48
J40333	Red Dura-Ink® 55 marker	12/48
J40334	Black Dura-Ink® 55 marker	12/48
J40335	Black Dura-Ink® 200 marker	12/24
J40336	White paint marker	12/48
J40337	Yellow paint marker	12/48
J40338	Red paint marker	12/48
J40339	Black paint marker	12/48
J40340	Blue paint marker	12/48
J40341	Paint marker display yellow, white, and black	1/1
J40343	Round counter display red and black	1/1

Industrial Choice Precision-Line Inverted Marking Paint



- Features a distance tip for easy-to-read, bright, vivid markings
- Marks more linear feet than the competition
- Virtually no overspray
- Fast-drying and non-clogging
- Can be applied down to 25°F
- Dries in 5 minutes or less
- Easy-to-use, spray through cap guaranteed not to clog
- "No Mess" spray tip keeps paint off finger
- Locking tip keeps tip from popping off
- Best resistance to premature chalking and fading
- GROUND TRANSPORTATION ONLY
- CARTON QUANTITIES ONLY

PART NO.	DESCRIPTION	CTN/MSTR
J40380	White marking paint	12/12
J40381	Yellow marking paint	12/12
J40382	Red marking paint	12/12
J40383	Blue marking paint	12/12
J40384	Green marking paint	12/12
J40385	Orange marking paint	12/12
J40387	Pink marking paint	12/12

Items marked with the Jones Stephens logo are "You Need It... We Got It" Items.

Paint Spotter Hand-Help Wand



- For quick, easy one-hand application of marking point
- Non-adjustable

PART NO.	DESCRIPTION	CTN/MSTR
J40386	Paint spotter	1/1

Acid Brush



- Tin handle
- CARTON QUANTITIES ONLY

PART NO.	DESCRIPTION	CTN/MSTR
B29700	3/8" x 6" acid brush	144/1728
B29701	1/2" x 6" acid brush	144/1428
B29702	9/16" x 6" acid brush	144/1008
B29699	1/4" x 3" acid brush	144/1428

Chip Brush



- Natural bristles
- Ideal for use with pipe cleaners, thread cutting oil, paint, pipe dope
- CARTON QUANTITIES ONLY

PART NO.	DESCRIPTION	CTN/MSTR
B29801	1" chip brush	36/36
B29802	2" chip brush	24/432

Chip Brush



- Pure 100% natural white color bristle
- Epoxy set bristles for lasting durability
- Can be used with all paints, glue, and stains
- Interior/exterior
- Smooth natural wood handles

PART NO.	DESCRIPTION	CTN/MSTR
B29805	1-1/2" chip brush	36/864
B29806	2" chip brush	36/864
B29807	3" chip brush	12/432
B29808	4" chip brush	12/288

Long Handle Wire Brush with Scraper



- Long bent handle
- 3x19 rows
- For removing rust and corrosion from metals, roughing-up wood and brushing loose stucco surfaces
- Oil tempered carbon steel wire tynes
- Smooth sanded hardwood block

PART NO.	DESCRIPTION	CTN/MSTR
B29901	Long handle wire brush with scraper	12/144

Shoe Handle Wire Brush with Scraper



- Shoe handle
- 4x16 rows
- For removing rust and corrosion from metals, roughing-up wood and brushing loose stucco surfaces
- Oil tempered carbon steel wire tynes
- Smooth sanded hardwood block

PART NO.	DESCRIPTION	CTN/MSTR
B29902	Shoe handle wire brush with scraper	12/144

Wire Brush



- For cleaning rough surfaces
- Stiff steel wire bristle
- Polished hardwood handle
- CARTON QUANTITIES ONLY

PART NO.	DESCRIPTION	CTN/MSTR
B29900	1" wire brush	12/72

Mini Scraper with 5 Replacement Blades



- Includes 5 extra blades

PART NO.	DESCRIPTION	CTN/MSTR
K50045	Mini scraper with 5 replacement blades	6/36

5 in 1 Painters Tool



- Solid plastic handle
- Mirror finish tempered high carbon steel blade
- Precision ground
- Full tang
- Professional grade

PART NO.	DESCRIPTION	CTN/MSTR
K50011	5 in 1 painters tool	10/100

Putty Knife



PART NO.	DESCRIPTION	CTN/MSTR
K50015	1-1/4" putty knife	12/144
K50020	1-1/2" putty knife	10/100
K50017	2" putty knife	10/100
K50016	3" putty knife	12/144
K50018	4" putty knife	10/50

Clip Point Putty Knife



- Solid plastic handle
- Mirror finish tempered high carbon steel blade
- Precision ground
- Full tang
- Professional grade

PART NO.	DESCRIPTION	CTN/MSTR
K50012	Clip point putty knife	10/100

Spray Weld



- Cleaner, Primer & Cement all-in-one!
- No Mess – No Waste
- Spray any angle
- Goes twice as far as brush and can method
- Work in a wider range of temperatures

PART NO.	DESCRIPTION	CTN/MSTR
S30800	11 oz. with purple primer	12/12
S30801	4.5 oz. with purple primer	12/12
S30802	11 oz. with clear primer	12/12
S30803	4.5 oz. with clear primer	12/12

Whitlam "Blue Magic" Pipe Joint Compound



- ORM-D
- Slow set
- Meets FED spec TT-S-1732
- Use on plastic and metal threads
- NSF listed
- GROUND TRANSPORTATION ONLY
- CARTON QUANTITIES ONLY



PART NO.	DESCRIPTION	CTN/MSTR
S95710	1/2 pint brush top can joint compound	24/24
S95711	1 pint brush top can joint compound	12/12
S96014	1/4 pint joint compound	24/24
S96016	1 quart pipe joint compound	12/12

Whitlam Seal Unyte



- Hard set
- Dark gray
- Semi-paste
- Use on all metal threaded connections and flanges

PART NO.	DESCRIPTION	CTN/MSTR
S95012	1/2 pint Whitlam seal unyte	24/24
S95014	1/4 pint Whitlam seal unyte	24/24
S96012	1 pint Whitlam seal unyte	12/12
S95016	1 quart Whitlam seal unyte	12/12

We Got It -

Whitlam "Select Unyte" Teflon Pipe Joint Compound



- ORM-D
- NSF listed
- Soft set, white virgin teflon (PTFE)
- Use on plastic and metal threads
- For use on air, steam, petroleum, water, gas and chemical lines
- GROUND TRANSPORTATION ONLY
- CARTON QUANTITIES ONLY



PART NO.	DESCRIPTION	CTN/MSTR
S95712	1/2 pint brush top can joint compound	24/24
S95713	1 pint brush top can joint compound	12/12

Slic-tite® Heavy Duty Thread Sealing Compound



- Working pressures: to 10,000 psi (liquids), 3,000 (gases)
- Temp: -50°F to +500°F
- Use for threaded connections on steel, aluminum, brass, PVC, CPVC & ABS



PART NO.	DESCRIPTION	CTN/MSTR
S95011	8 fl. oz. Slic-tite® HD thread sealing compound	1/24
S95010	Pint Slic-tite® HD thread sealing compound	1/24

Cool Gel®



- Protects surfaces and components from heat damage such as piping, drywall, and shower valves
- Used for any soldering or brazing job
- Safe, non-toxic, and harmless to the skin
- Will evaporate in 24-48 hrs. eliminating cleanup
- Unique gelling formula sticks to any surface without dripping or running off



PART NO.	DESCRIPTION	CTN/MSTR
S95100	1 qt. Cool Gel®	1/12
S95101	1 pt. Cool Gel®	1/24

Liquid Lightning Pro Drain Opener



- Organic digester; biodegradable
- Dissolves grease, hair, sanitary napkins, sludge, soap and paper
- Environmentally safe
- ORM-D (S95701/S95793) GROUND TRANSPORTATION ONLY
- HAZMAT (S95794/S95795) LIGHT TRUCK LOAD ONLY
- CARTON QUANTITIES ONLY

PART NO.	DESCRIPTION	CTN/MSTR
S95701	1 pint drain opener	12/12
S95793	1 quart drain opener	12/12
S95794	1/2 gallon drain opener (HAZMAT)	6/6
S95795	1 gallon drain opener (HAZMAT)	4/4

Plumber's Goop Adhesive



- 3.7 oz. tube
- Watertight bond for use on PVC, tile or porcelain
- ORM-D
- GROUND TRANSPORTATION ONLY
- CARTON QUANTITIES ONLY

PART NO.	DESCRIPTION	CTN/MSTR
J45100	3.7 oz. tube plumber's goop adhesive	12/12

Items marked with the Jones Stephens logo are "You Need It...We Got It" Items.

Drain King® Mini Snake



- Unclogs sinks, showers, bath drains & urinals
- Safe, easy to use
- No chemicals

PART NO.	DESCRIPTION	CTN/MSTR
D18190	Mini snake	36/144

Cloth Inserted Plunger Disc



- Cloth inserted rubber

PART NO.	DESCRIPTION	CTN/MSTR
D18052	3" cloth inserted plunger disc	5/30
D18051	4" cloth inserted plunger disc	5/30
D18050	Plunger disc holder	30/300

Plumber's Faucet and Valve Grease



- Lubricates faucet stems, threads, o-rings, packing, gaskets
- Resists high temperatures
- Counter display
- CARTON QUANTITIES ONLY

PART NO.	DESCRIPTION	CTN/MSTR
S95709	2.0 fl.oz. tins in counter display	12/12

Plumber's Putty



- Use on sinks, strainers, faucets and other fixtures wherever a non-drying watertight seal is needed
- DO NOT USE ON MARBLE OR PLASTIC!!!
- Meets Federal Specification TTP-1536
- CARTON QUANTITIES ONLY

PART NO.	DESCRIPTION	CTN/MSTR
P40014	14 oz. putty	24/24
P40080	5 lb. putty	6/6

Plumber's Epoxy Putty



- Seal leaks in sink traps, water tanks, pipe joints, drain leaks and radiators
- Stop leaks in pools and drain lines
- Repair cracked porcelain wall tiles, floor tiles and fixtures
- CARTON QUANTITIES ONLY

PART NO.	DESCRIPTION	CTN/MSTR
P40004	4 oz. Epoxy putty tubes in counter display	12/12

Visu-Glow Leak Detector



- Fluorescent gas leak detector



PART NO.	DESCRIPTION	CTN/MSTR
S95200	8 oz. Visu-Glow leak detector	1/24

2CanCaddy™



- Grab and go handle
- Special velcro strap to keep cans organized and secure
- Works well with all size cans up to 32 oz.
- Made of extremely durable polymer
- Easily cleans, stain resistant and virtually indestructible
- Perfect for Plumbers, Electricians, Painters & more

PART NO.	DESCRIPTION	CTN/MSTR
S95015	2CanCaddy™	1/12

20 Compartment Parts Box



- Includes extra dividers to increase the amount of compartments

PART NO.	DESCRIPTION	CTN/MSTR
T60130	20 compartment parts box	1/6

Steel Nipple Caddy Tray



- Steel construction
- Baked epoxy finish
- Push away handles
- Nipple storage range (close-6")

PART NO.	SIZE	DIMENSIONS	CAPACITY	CTN/MSTR
N70050	1/2"	10-1/2" x 7" x 6-1/2"	77 pieces	1/8
N70075	3/4"	12-1/2" x 7" x 6-1/2"	66 pieces	1/8
N70016	1"	14-1/8" x 7-3/4" x 6-1/2"	50 pieces	1/6
N70020	1-1/4"	18" x 8" x 6-1/2"	40 pieces	1/8
N70024	1-1/2"	19-1/2" x 6-1/2" x 6-1/2"	30 pieces	1/8
N70032	2"	23-7/8" x 8-1/2" x 6-1/2"	27 pieces	1/4

1/2" & 3/4" Combo Nipple Caddy



- Holds 39 1/2" x close-6"
- Holds 33 3/4" x close-6"
- Steel construction with baked epoxy finish
- Fold over handle

PART NO.	DESCRIPTION	DIMENSIONS	CTN/MSTR
N70575	Combo Caddy	12 1/8" x 7" x 6 1/2"	1/8

Fitting Tote Tray



- Excellent for copper and PVC fittings
- Steel construction with baked epoxy finish
- Inside compartments measure 4-7/8" x 4-7/8" x 3-7/8"
- 8 compartments
- Fold over handle

PART NO.	DESCRIPTION	DIMENSIONS	CTN/MSTR
N70500	Fitting Caddy	20" x 10-1/2" x 5"	1/4

Utility Tote Tray



- Lightweight, durable, high impact plastic

PART NO.	DESCRIPTION	DIMENSIONS	CTN/MSTR
T60100	Tote tray	10" x 15" x 5"	1/12

Plastic Nipple Caddy



- High impact plastic
- Strong and lightweight
- Will not rust or corrode
- Nipple storage range (close-6")

PART NO.	SIZE	DIMENSIONS	CAPACITY	CTN/MSTR
N70150	1/2"	11" x 7-1/2" x 6-1/2"	77 pieces	1/4
N70175	3/4"	13-1/4" x 7-7/8" x 6-1/2"	66 pieces	1/4
N70200	1"	14-3/4" x 8-1/8" x 6-1/2"	50 pieces	1/4
N70250	1-1/2"	21" x 7" x 6-1/2"	30 pieces	1/2
N70300	2"	23-1/4" x 8-1/2" x 6-1/2"	27 pieces	1/2

Tool Totes



- High density polyethylene construction resistant to acids, chemicals, oils and glues
- Removable dividers
- Reinforced metal handle
- Made in the USA

MADE IN THE USA

PART NO.	DESCRIPTION	CTN/MSTR
T60121	12" x 24" x 6" deep tray with 4 dividers	1/5
T60122	9" x 15" x 5" deep tray with 4 dividers	1/10
T60123	9" x 15" x 3" deep tray with 4 dividers	1/10
T60124	12-1/2" x 18" x 4-1/2" deep tray	1/5
T60125	Extra divider for T60121	1/4
T60126	Extra divider for T60122	1/4
T60127	Extra divider for T60123	1/4

Bucket Caddies



- 5 gallon high-impact red plastic bucket holds 4 combinations of trays- 3 large; 6 small; 1 large with 4 small; and 2 large with 2 small
- All trays have 4 sections; use tray subdividers to increase small tray capacity up to 8 sections
- Tool apron fits 5 and 3 1/2" gallon buckets; apron straps on or can be permanently secured (hardware included)
- Made in the USA

MADE IN THE USA

PART NO.	DESCRIPTION	CTN/MSTR
T60101	5 gallon bucket with 6 small trays	1/8
T60102	5 gallon bucket with 1 large tray & 4 small trays	1/8
T60103	Large trays (4-1/2" deep)	1/3
T60104	Small trays (2-1/2" deep)	1/6
T60105	Lid for 5 gallon bucket	1/1
T60106	5 gallon bucket only	1/1
T60107	Subdividers for small trays (4 pack)	1/1
T60108	20-pocket tool apron	1/1
T60110	5 gallon bucket with 2 large and 2 small trays	1/1
T60111	5 gallon bucket with 3 large trays	1/1

Anti-Vibration Synthetic Leather Gloves



- Neoprene knuckle protection
- Flexible 4-way stretch
- Sure Grip™ reinforced thumb saddle
- Gel-padded Sure Grip™ patch palm
- Machine-washable Parity™
- CARTON QUANTITIES ONLY

PART NO.	DESCRIPTION	CTN/MSTR
G50211	Pair synthetic leather gloves	12/12

Items marked with the Jones Stephens logo are "You Need It... We Got It" Items.

Nitrile Gloves



- 3/4 coating offers more protection
- Micro foam nitril offers great grip
- Coating draws oil and water aside to allow for enhanced grip
- Good abrasion resistance
- Silicone free and antibacterial
- CARTON QUANTITIES ONLY

PART NO.	DESCRIPTION	CTN/MSTR
G50215	Pair nitrile gloves	12/12

Polyester Nitrile Dipped Palm Gloves



- 100% polyester
- Large/X-large
- Pair
- Knit wrist to keep out dirt

PART NO.	DESCRIPTION	CTN/MSTR
G50225	Polyester nitrile dipped palm gloves	12/144

Blue Nitrile Gloves



- Powdered
- Priced per box
- 100 per box (50 pair)
- Thickness: 3 mil.

PART NO.	DESCRIPTION	CTN/MSTR
G50230	Blue nitrile gloves - size large/XL	1/10
G50231	Blue nitrile gloves - size medium/large	1/10

All Purpose Latex Palm/Mesh Back Gloves



- Durable
- Excellent in wet conditions
- Protects hands during rugged jobs
- CARTON QUANTITIES ONLY

PART NO.	DESCRIPTION	CTN/MSTR
G50202	Latex palm/mesh back gloves	12/240

Disposable Blue Latex Gloves



- 14 mil
- Priced per box
- 50 per box
- Powder free
- Examination grade
- Large

PART NO.	DESCRIPTION	CTN/MSTR
G50212	Disposable blue latex gloves	1/10

Industrial Rubber Gloves



- Extra heavy
- Large
- Pair
- Rolled cuffs
- CARTON QUANTITIES ONLY

PART NO.	DESCRIPTION	CTN/MSTR
G50223	14" smooth hands, 30 mil	12/72
G50220	18" rough hands, 25 mil	10/60

Brown Jersey Gloves



- 100% brown cotton
- One size fits all
- Knit wrist
- 8 ounce
- Priced per pair
- CARTON QUANTITIES ONLY

PART NO.	DESCRIPTION	CTN/MSTR
G50200	Brown cotton jersey glove (carded)	12/300
G50210	Brown cotton jersey glove (display- 216 pairs)	1/1

Economy Brown Jersey Gloves



- Made of cotton
- Large
- Close fitting knit wrist
- Comfortable
- Straight thumb
- Full size
- Priced per pair
- CARTON QUANTITIES ONLY

PART NO.	DESCRIPTION	CTN/MSTR
G50300	Economy brown cotton jersey glove (carded)	12/144

White Canvas Work Gloves



- Canvas
- Knit wrists
- Large/X-large
- CARTON QUANTITIES ONLY

PART NO.	DESCRIPTION	CTN/MSTR
G50228	White canvas work gloves	12/144

White Cotton Gloves with Grippers



- Durable 100% cotton canvas
- No-slip grip on palm
- One size fits all
- Knit wrist
- Priced per pair
- CARTON QUANTITIES ONLY

PART NO.	DESCRIPTION	CTN/MSTR
G50205	White cotton gloves with rubber dots (bulk)	12/240
G50206	White cotton gloves with rubber palms (bulk)	12/240
G50229	White cotton gloves with PVC dots (carded)	12/144

Leather Palm Work Gloves



- Split leather palm, thumb, fingers and knuckles
- 100% Cotton back and liner
- Safety cuff
- Priced per pair
- CARTON QUANTITIES ONLY

PART NO.	DESCRIPTION	CTN/MSTR
G50204	Leather palm low safety cuff (carded)	12/120
G50214	Leather palm low safety cuff (display)	96 pair

Items marked with the Jones Stephens logo are "You Need It... We Got It" Items.

Drivers' Style Leather Gloves



- Durable and long lasting - conforms to your hand with time
- Grain leather glove
- Elastic cuff
- Priced per pair
- CARTON QUANTITIES ONLY

PART NO.	DESCRIPTION	CTN/MSTR
G50208	Drivers' style leather (carded)	12/120
G50218	Drivers' style leather (display - 48 pair)	1/1

Vinyl Gloves



- 5 mil.
- One size fits all
- Lightly powdered
- 100 reversible gloves (50 pair)

PART NO.	DESCRIPTION	CTN/MSTR
G50250	100 vinyl gloves	1/10

Disposable Vinyl Gloves



- One size fits all
- Rolled cuff
- Lightly powdered for easy on and off
- Ready to hang or place on shelf

PART NO.	DESCRIPTION	CTN/MSTR
G50251	20 pack disposable gloves	1/20



- One size fits all
- Non-powdered
- Non-sterile
- Heavy duty
- Multi-purpose
- Carded

PART NO.	DESCRIPTION	CTN/MSTR
G50302	8 pack disposable gloves	12/72

Hornet and Wasp Spray



- Long range spray- shoots a stream up to 20 feet, reaching nests far above ground, letting you keep a comfortable distance from the nest
- Contains no CFCs which deplete the ozone layer
- GROUND TRANSPORTATION ONLY
- ORM-D
- CARTON QUANTITIES ONLY

PART NO.	DESCRIPTION	CTN/MSTR
J40393	20 oz. can hornet & wasp spray	12/12

50 Pound UV Black Cable Tie



- Black UV rated for outdoor use
- UL Listed



PART NO.	DESCRIPTION	CTN/MSTR
J40116	7" long cable ties	100 per bag/10,000
J40117	11" long cable ties	50 per bag/5,000

Nylon Cable Ties



Natural Color



Black

- Standard size
- Nylon
- CARTON QUANTITIES ONLY

PART NO.	DESCRIPTION	CTN/MSTR
J40107	7" long (1/16" - 1-3/4") natural	100/6600
J40111	11" regular (1/16" - 3") natural	100/18700
J40115	15" (5/16") black	100/2300

Heat and UV Stabilized Nylon Cable Ties



- Heat & UV stabilized nylon-66
- Priced per bag of 100

PART NO.	DESCRIPTION	CTN/MSTR
J40433	4" 18lb. natural cable ties	12/72
J40434	6" 18lb. natural cable ties	12/72
J40435	8" 40lb. natural cable ties	12/72
J40436	11" 50lb. natural cable ties	12/72
J40437	14" 50lb. natural cable ties	12/72
J40438	17" 50lb. natural cable ties	12/72
J40443	4" 18lb. black cable ties	12/72
J40444	6" 18lb. black cable ties	12/72
J40445	8" 40lb. black cable ties	12/72
J40446	11" 50lb. black cable ties	12/72
J40447	14" 50lb. black cable ties	12/72
J40448	17" 50lb. black cable ties	12/72

Duct Straps



- HVAC application
- Natural nylon
- Up to 10" diameter
- CARTON QUANTITIES ONLY

PART NO.	DESCRIPTION	CTN/MSTR
J40134	34" duct straps	10 per bag/500

Poly Pro Rope



PART NO.	DESCRIPTION	CTN/MSTR
T60007	3/8" x 50' poly pro rope	1/25

Heavy Duty Utility Strap



- Plated S-hooks
- Meets or exceeds ASTM standards
- Weather and wear resistant
- Made in the USA
- CARTON QUANTITIES ONLY

MADE IN THE USA

PART NO.	DESCRIPTION	CTN/MSTR
S20015	15" heavy duty utility strap	25/25
S20021	21" heavy duty utility strap	25/25
S20031	31" heavy duty utility strap	25/25
S20041	41" heavy duty utility strap	25/25

Ratchet Tie Down Strap



- 1" wide/400 lb. working load limit
- Comfort grip handles
- Weather and corrosion resistant
- PVC coated hooks that will not scratch
- Cut and abrasion resistant webbing

PART NO.	DESCRIPTION	CTN/MSTR
S20300	1" x 16' ratchet tie down strap	1/4

Camouflage Strap with Hooks



- 1" wide/300 lb. working load limit
- 2 hooks included with each strap; pack of 4 ratchet straps

PART NO.	DESCRIPTION	CTN/MSTR
S20301	1" x 9' camo strap with hooks	1/6

Ratchet Strap with Step Release J-Hooks



- 2" wide/ 3,333 lb. working load limit
- Step by step release action
- Gradually releases tension with double J-hook
- Flex grip handle

PART NO.	DESCRIPTION	CTN/MSTR
S20302	2" x 27' Ratchet strap	1/8

Cam Straps



- 1" wide / 750# test nylon straps
- All colored straps and threads are UV resistant
- Straps are secured by a heavy duty zinc plated metal cam buckle, which will not slip even in wet conditions
- Ideal for handling loads for all kinds of contractor needs

PART NO.	DESCRIPTION	CTN/MSTR
S20100	1" x 2' black single pack	24/144
S20101	1" x 4' red single pack	24/144
S20102	1" x 6' yellow single pack	24/144
S20103	1" x 8' green single pack	24/144
S20104	1" x 10' blue single pack	24/144
S20105	1" x 12' purple single pack	24/144
S20106	1" x 20' black single pack	24/72
S20200	1" x 2' black - twin pack	1/1
S20201	1" x 4' red - twin pack	1/1
S20202	1" x 6' yellow - twin pack	1/1
S20203	1" x 8' green - twin pack	1/1
S20204	1" x 10' blue - twin pack	1/1

Items marked with the Jones Stephens logo are "You Need It...We Got It" Items.

3-N-1 Tubing Bender



- For 1/4", 5/16" or 3/8" tubing

PART NO.	DESCRIPTION	CTN/MSTR
T50001	3-N-1 tubing bender	10/20

Spring Tubing Bender



- Spring prevents collapse of the wall at bending point
- Allows fast free-form bending of soft copper and aluminum tube

PART NO.	DESCRIPTION	CTN/MSTR
J41030	3/8" spring tubing bender	1/200
J41031	1/2" spring tubing bender	1/100
J41032	5/8" spring tubing bender	1/100

WD-40® Lubricant



- Cleans
- Protects against rust and corrosion
- Lubricates
- Penetrates stuck metal parts
- Displaces moisture
- Low VOC
- ORM-D
- GROUND TRANSPORTATION ONLY
- CARTON QUANTITIES ONLY

PART NO.	DESCRIPTION	CTN/MSTR
S95800	8 oz. can lubricant low VOC	12/12

Gas Line Marking Labels



- Yellow self adhesive stickers
- Clearly identifies gas lines from other utility and water lines
- 100 labels per roll

PART NO.	DESCRIPTION	CTN/MSTR
J40481	2 PSI gas line stickers	1/100
J40482	Gas line stickers	1/100

E-Z Light



- Extendable for lighting flames from a distance
- Safe and convenient for torch, fireplace, or any hard-to-reach area

PART NO.	DESCRIPTION	CTN/MSTR
J40450	E-Z light	1/12

E-Z Reach



- Extendable, magnetized arm for easy retrieval of small metal parts
- Great for shop or job site

PART NO.	DESCRIPTION	CTN/MSTR
J40451	E-Z reach	24/240

24" Grab-It Tool



- Makes hard-to-reach areas accessible using retractable fingers

PART NO.	DESCRIPTION	CTN/MSTR
J40020	24" Grab-it tool	1/50

Steel Wool



- Packaged 16 pads per bag, 12 bags per carton
- Priced per bag

PART NO.	DESCRIPTION	CTN/MSTR
B29300	Size 00 steel wool	1/6
B29310	Size 0 steel wool	1/6

Copper Cleaning Pad

G



- Reusable
- Use wet or dry - will not clog
- Nylon impregnated fine maroon
- Good general cleaner for removing rust, corrosion, etc.
- Deoxidizes and cleans copper tube and fittings for soldering
- CARTON QUANTITIES ONLY

PART NO.	DESCRIPTION	CTN/MSTR
B29400	4" x 6-1/4" x 1/4" cleaning pad	10/710

Lead Joint Runner



PART NO.	DESCRIPTION	CTN/MSTR
L42011	#1 - 2" - 4" pipe size	1/10
L42012	#2 - 4" - 6" pipe size	1/10
L42013	#3 - 6" - 10" pipe size	1/5
L42014	#4 - 10" - 14" pipe size	1/1
L42015	#5 - 16" - 20" pipe size	1/1
L42016	#6 - 20" - 24" pipe size	1/1
L42017	#7 - 24" - 30" pipe size	1/1
L42018	#8 - 30" - 36" pipe size	1/1
L42019	#9 - 36" - 42" pipe size	1/1
L42023	#10 - up to 48" pipe size	1/1

7-1/2" Torpedo Level



- Manufactured to rigid requirements
- Professional quality
- Aluminum construction
- Magnetic sides



PART NO.	DESCRIPTION	CTN/MSTR
J40100	7-1/2" torpedo level	1/10

9" Torpedo Level with Magnetic Strip



- Top read window simplifies readings in confined areas
- High impact ABS plastic frame
- Full length magnetic edge on one side
- Carded

PART NO.	DESCRIPTION	CTN/MSTR
J40102	9" torpedo level with magnetic strip	6/36

Plastic Magnetic Level



- Has front vial viewer
- Saves time and money
- Eliminates neck and back strain
- Internal aluminum frame for accuracy and strength
- Magnetic
- Integrated Euroslot hanging hole

PART NO.	DESCRIPTION	CTN/MSTR
J42101	10" Plastic magnetic level	1/6

Top Grade Gradient Level



- The ultimate plumbing level
- Set accurate slopes of 1 and 2 percent
- Includes conversion of pitch and slope
- Accuracy: 0.5mm/ M-0.029" on all vials
- Length: 60cm/24"
- U.S. patent 6,209,211

PART NO.	DESCRIPTION	CTN/MSTR
J42200	24" length gradient level	1/6

Industrial Swivel-Lite Flashlight



F20016



F20017

- Contractor grade construction
- Sure grip rubber handles

PART NO.	DESCRIPTION	CTN/MSTR
F20017	Flashlight for D batteries	1/6

Rayovac Floating Lantern and Battery



F20003



F20004



F20005

- 6-volt F20004 battery included
- Heavy duty battery priced each

PART NO.	DESCRIPTION	CTN/MSTR
F20003	Floating lantern with battery	1/6
F20004	6 volt spring top - battery only	1/12
F20005	6 volt screw top - battery only	1/4

Rayovac Industrial Flashlight



- Yellow flashlights with ring hangers

PART NO.	DESCRIPTION	CTN/MSTR
F20001	2 cell D size flashlight	1/6
F20002	3 cell D size flashlight	1/6

4 D/6 Volt Swivel-Lite



- Contractor grade construction
- Krypton bulb, spare bulb holder
- Floats in water (with beam up)
- Long range beam
- 45° swivel for hands-free use
- Comfort-grip handle, push-button switch
- No batteries included
- Can use 6V lantern battery for additional power

PART NO.	DESCRIPTION	CTN/MSTR
F20018	4D/ 6-Volt Swivel-Lite	1/6

Sportsman LED Head-Lite



- New technology unique 3-way hands-free L.E.D. system
- Close range use super white L.E.D., "Night vision" 2 super red L.E.D., Long range beam-krypton bulb
- Batteries last 20 times longer with L.E.D. bulbs than normal bulbs
- Rubber spot-flood reflector, head rotates 180° compact design, comfort-grip band
- Weatherproof, heavy duty construction

PART NO.	DESCRIPTION	CTN/MSTR
F20019	Sportsman LED head-lite	1/4

8 LED Flashlight



- With magnifying lenses
- Push button switch
- Impact resistant
- Comfort grip
- Handy strap
- Uses 3 AAA batteries (included)

PART NO.	DESCRIPTION	CTN/MSTR
F20052	8 LED flashlight	6/48

24 LED Twist Light



- (2) 12 LED super bright lights
- Versatile flexible body
- Removable heads to use as single flashlights
- Use for emergencies, repairs and more!
- Uses 6 AAA batteries - 3 per side (not included)

PART NO.	DESCRIPTION	CTN/MSTR
F20050	24 LED twist light	1/6

1 Watt LED Flashlight



- With adjustable beam
- Narrow to wide focus
- Aluminum body
- Wrist strap
- 3 light options: high, low and safety flash
- Uses 3 AAA batteries (not included)

PART NO.	DESCRIPTION	CTN/MSTR
F20054	1 watt LED flashlight with adjustable beam	6/48

3 Watt LED Flashlight



- Aluminum body
- Large easy grip
- 3 light options: high, low and safety flash
- Uses 3 AAA batteries (not included)

PART NO.	DESCRIPTION	CTN/MSTR
F20053	3 watt LED flashlight	6/48

5 Watt LED Flashlight



- Aluminum body
- Includes charger
- 3 light options: high, low and safety flash
- Rechargeable lithium ion battery (included)

PART NO.	DESCRIPTION	CTN/MSTR
F20055	5 watt LED flashlight with charger	6/48

27 LED Utility Light



- With magnetic back and folding swivel hook
- 24 LED light
- 3 LED flashlight
- Push button switch
- Uses 3 AAA batteries (included)
- Display contains 12 lights
- CARTON QUANTITIES ONLY

PART NO.	DESCRIPTION	CTN/MSTR
F20051	27 LED utility light display	12/48

Portable Halogen Work Light



- 6 ft. grounded
- 500 watt
- Power cord
- Adjustable frame

PART NO.	DESCRIPTION	CTN/MSTR
E25250	500 watt halogen light	1/6
H500X2	(2) replacement bulbs - RSC base T3 (J-type)	12/144

Clamp-On Light



- Reflector lamp for general shop and industrial applications
- 8" shade, 6 ft. cord
- On/Off switch
- Use 75 watt max type "A" bulb (not included)
- Boxed

PART NO.	DESCRIPTION	CTN/MSTR
E25251	Clamp-on light with 8" shade	1/4

Orange Trouble Light



- Industrial quality
- 25 ft. 16/3 SJT cord
- 3-prong side outlets
- Metal cage

PART NO.	DESCRIPTION	CTN/MSTR
E25021	Orange trouble light with metal cage	1/12

Orange Extension Cord



- Safety orange color
- Heavy duty
- Outdoor/grounded
- ETL Listed

PART NO.	DESCRIPTION	CTN/MSTR
E25000	16/3 SJT 15 ft. extension cord	6/24
E25001	16/3 SJT 25 ft. extension cord	6/24
E25002	16/3 SJT 50 ft. extension cord	6/12
E25004	16/3 SJT 100 ft. extension cord	1/6
E25005	12/3 SJT 25 ft. extension cord	1/8
E25006	12/3 SJT 50 ft. extension cord	1/6
E25007	12/3 SJT 100 ft. extension cord	1/4
E25040	14/3 SJT 25 ft. extension cord	1/12
E25041	14/3 SJT 50 ft. extension cord	1/8
E25042	14/3 SJT 100 ft. extension cord	1/4
E25045	14/3 25 ft. Lighted End Extension Cord	2/12
E25046	14/3 50 ft. Lighted End Extension Cord	2/8

Round Extension Cord Power Block



- 14/3 SJT
- 15 AMP
- 125 V
- ETL Listed

PART NO.	DESCRIPTION	CTN/MSTR
E25010	3 ft. round extension cord block	12/48

Grey Appliance Cord



- Heavy duty
- 15 AMP
- 3 wire
- ETL Listed

PART NO.	DESCRIPTION	CTN/MSTR
E25200	14/3 SPT-3 3 ft. extension cord	10/50
E25201	14/3 SPT-3 6 ft. extension cord	10/50
E25202	14/3 SPT-3 9 ft. extension cord	5/25
E25203	14/3 SPT-3 12 ft. extension cord	5/25
E25204	14/3 SPT-3 15 ft. extension cord	5/25

GFCI Safety Outlet



- LED trip indicator
- Side and back wired
- Tamper resistant
- Wall planes included
- Boxed
- ETL Listed

PART NO.	DESCRIPTION	CTN/MSTR
E26001	15 AMP, ivory safety outlet	6/24
E26002	15 AMP, white safety outlet	6/24
E26003	20 AMP, ivory safety outlet	6/24
E26004	20 AMP, white safety outlet	6/24

Rayovac® Industrial Batteries



- Priced per battery
- PACK QUANTITIES ONLY

PART NO.	DESCRIPTION	CTN/MSTR
F20006	Heavy duty C batteries	6/72
F20007	Heavy duty D batteries	6/72
F20012	AAA alkaline batteries	8/96
F20008	AA alkaline batteries	8/96
F20009	9 volt alkaline batteries	6/72
F20010	C alkaline batteries	6/72
F20011	D alkaline batteries	6/72

Duracell® Alkaline Batteries



- Priced per pack
- Carded
- PACK QUANTITIES ONLY

PART NO.	DESCRIPTION	CTN/MSTR
F20020	AAA alkaline batteries - 2 pack	1/50
F20021	AAA alkaline batteries - 4 pack	1/50
F20022	AA alkaline batteries - 2 pack	1/50
F20023	AA alkaline batteries - 4 pack	1/50
F20024	C alkaline batteries - 2 pack	1/30
F20025	D alkaline batteries - 2 pack	1/48
F20026	9 volt alkaline battery	1/50

Cutting Oil



- Medium brown color

PART NO.	DESCRIPTION	CTN/MSTR
J45005	Premium all-purpose oil (gallon)	1/6

Poly Sheeting



- Clear
- 4 mil super tough plastic
- Hundreds of uses
- Made in the USA

MADE IN THE
USA

PART NO.	DESCRIPTION	CTN/MSTR
S08100	8' x 100' poly sheeting	1/1
S10100	10' x 100' poly sheeting	1/1

Garbage Disposal Cord



- 16/3 gauge wire

E25015
E25016

E25017
E25018

PART NO.	DESCRIPTION	CTN/MSTR
E25015	3' straight disposal cord	1/50
E25016	6' straight disposal cord	1/50
E25017	3' angle disposal cord	1/50
E25018	6' angle disposal cord	1/50

Garbage Disposal Wiring Kit



- Complete with 3 wire nuts and connector coupling
- 16/3 gauge wire
- Polybagged

PART NO.	DESCRIPTION	CTN/MSTR
E25115	Kit for 3' cord with straight plug	1/1
E25116	Kit for 6' cord with straight plug	1/1
E25117	Kit for 3' cord with angle plug	1/1
E25118	Kit for 6' cord with angle plug	1/1

Screw-On Wire Connector



- Clamshell packaging
- Ready to hang!

PART NO.	DESCRIPTION	CTN/MSTR
E25125	Gray	1/100
E25126	Blue	1/100
E25127	Orange	1/100
E25128	Yellow	1/45
E25129	Red	1/45

G

Leak Alert Water Detector



- Loud alarm sounds with direct water contact
- Floats and signals for up to 72 hours
- Fully automatic operation - no wiring required
- Low battery indicator for optimum safety and performance

PART NO.	DESCRIPTION	CTN/MSTR
L95400	Leak alert water detector	1/12

GASKETS AND COUPLINGS

Gaskets 313
Couplings 314
Import Couplings..... 315



*Published March 2017. List prices can be found in list price book and on our website.

Multi-Tite Gasket



SERVICE WEIGHT



EXTRA HEAVY

MADE IN THE
USA

- Multi rings on outside make this gasket the easiest to install
- Meets ASTM Standard C564

Service Weight

PART NO.	SIZE	CTN/MSTR
V95002	2"	1/150
V95003	3"	1/75
V95004	4"	1/60
V95005	5"	1/30
V95006	6"	1/30
V95008	8"	1/20
V95010	10"	1/10
V95012	12"	1/10
V95015	15"	1/5

Extra Heavy

PART NO.	SIZE	CTN/MSTR
V94004	4"	1/60

Dual Tite Gasket



SERVICE WEIGHT



EXTRA HEAVY

MADE IN THE
USA

- Meets ASTM Standard C564

Service Weight

PART NO.	SIZE	CTN/MSTR
V96002	2"	1/150
V96003	3"	1/75
V96004	4"	1/60
V96005	5"	1/30
V96006	6"	1/30
V96008	8"	1/20
V96010	10"	1/10
V96012	12"	1/10
V96015	15"	1/5

Extra Heavy

PART NO.	SIZE	CTN/MSTR
V97002	2"	1/150
V97003	3"	1/75
V97004	4"	1/60
V97005	5"	1/30
V97006	6"	1/30
V97008	8"	1/20
V97010	10"	1/10
V97012	12"	1/10
V97015	15"	1/5

Dual Tite Buna N "Nitrile" Gasket



MADE IN THE
USA

PART NO.	SIZE	CTN/MSTR
V98002	2"	1/150
V98003	3"	1/75
V98004	4"	1/60
V98005	5"	1/30
V98006	6"	1/30
V98008	8"	1/20
V98010	10"	1/10
V98012	12"	1/10
V98015	15"	1/5

Pipe Lubricant



MADE IN THE
USA

- L95202 - ORM-D. Ships UPS Ground and Motor Freight ONLY
- CARTON QUANTITIES ONLY

PART NO.	DESCRIPTION	CTN/MSTR
L95200	Quart lubricant	12/12
L95201	Gallon lubricant	4/4
L95202	Quart adhesive lube	12/12

H&I

No Hub Coupling



- Manufactured in accordance with CISPI Standard 310
- Gasket sleeve conforms to ASTM C564
- Screw is ASI 305 stainless steel

MADE IN THE USA

PART NO.	SIZE	CTN/MSTR
U95001	1-1/2"	1/100
U95002	2"	1/100
U95003	3"	1/100
U95004	4"	1/100
U95005	5"	1/20
U95006	6"	1/20
U95008	8"	1/10
U95010	10"	1/10
U95012	12"	1/12
U95015	15"	1/6
U95211	2" x 1-1/2"	1/100
U95320	3" x 2"	1/100
U95430	4" x 3"	1/60

No Hub Torque Wrench



- Automatic release at 60 in.lb.
- Ratchets one way
- Built-in reversing lever
- Chrome vanadium socket

PART NO.	DESCRIPTION	CTN/MSTR
T60060	No hub torque wrench	20/80

Mega Torque Wrench



- Heavy duty construction with chrome vanadium 5/16" or 3/8" sockets
- Socket kit includes screw and washer
- Slide down locking reversing feature

PART NO.	DESCRIPTION	CTN/MSTR
T60065	60 lb. - 5/16"	15/60
T60080	80 lb. - 3/8"	15/60
T60081	80 lb. - 5/16"	15/60
T60066	5/16" socket kit	15/60

Medium Duty No Hub Coupling



- Manufactured in accordance with CISPI Standard 310
- 9/16" stainless steel bands
- Stainless steel housing and shield
- 5/16" stainless steel screws
- 80 inch/lb. installation torque
- UPC listed

PART NO.	SIZE	CTN/MSTR
U97001	1-1/2"	1/60
U97002	2"	1/75
U97003	3"	1/48
U97004	4"	1/48
U97005	5"	1/15
U97006	6"	1/15
U97008	8"	1/15
U97010	10"	1/12

Heavy Duty No Hub Coupling



- Manufactured in accordance with CISPI Standard 310
- 9/16" stainless steel bands
- Stainless steel housing and shield
- 3/8" stainless steel screws
- 80 inch/lb. installation torque
- UPC listed

MADE IN THE USA

PART NO.	SIZE	CTN/MSTR
HDNHC1	1-1/2"	1/60
HDNHC2	2"	1/75
HDNHC3	3"	1/48
HDNHC4	4"	1/48
HDNHC5	5"	1/15
HDNHC6	6"	1/15
HDNHC8	8"	1/15
HDNHC10	10"	1/12

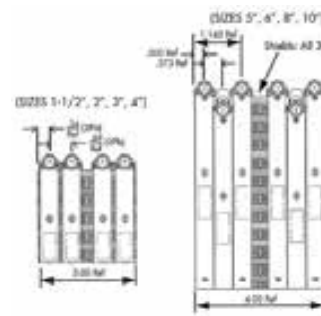

DESCRIPTION: Couplings consist of gasket and shield assemblies, the shield assemblies have four or six clamps depending on size. The clamps are fastened with eyelets to the bi-directional corrugated shield.

MATERIALS: Steels used in couplings are stainless steels. Shields, bands and housings are AISI 304. Screws and eyelets are AISI 305. Gaskets are neoprene rubber.

SPECIFICATIONS: Couplings conform to CISPI 310, Factory Mutual EN 1618. Couplings comply with ASTM C564, ASTM 1277, IAPMO file #3198, Commonwealth of Massachusetts CMR-248 and City of New York MEA 253-98-E. Gaskets are made from an elastomeric compound that meets the requirements of ASTM C564.

COUPLING SIZE	INSTALLATION TORQUE	CLAMPS FOR COUPLING
1-1/2"	80	4
2"	80	4
3"	80	4
4"	80	4
5"	80	6
6"	80	6
8"	80	6
10"	80	6



Larger Hex Head Screw: The new 3/8" hex head screw is designed to apply the full load of 80in/lbs. of insulation torque to the band/shield assembly.



Patented Bi-directional Shield Design: Our unique shield design employs bi-directional corrugations for maximum transfer of pressure from the clamps the gasket. This patented shield design adjusts to differences in the circumference and outside diameters for the pipes being joined. This eliminates gasket wrinkling and thereby eliminates leak paths. These parallel and transverse patterns on the gasket and pipe work to avoid pullout failures and provides a positive, reliable seal.



Specially Beaded Gaskets: The heavy-duty coupling utilizes a specially beaded gasket that mates with the shield and clamping forces for superior sealing pressure and holding power. IDEAL gaskets comply with ASTM C564.



Floating Eyelet Design: "Floating eyelets" fasten the clamps to the shield, allowing the clamp band and shield to move independently. This freedom prevents the shield from crimping during tightening, which can lead to leakage later on.



Mechanical Interlocking Clamp Design: IDEAL clamps feature a one-piece screw housing that mechanically interlocks the housing to the band. This one-piece housing design eliminates leak paths that can occur in staked or welded clamps.



Green Shield: The distinctive green shield quickly identifies the newly re-engineered IDEAL Heavy-Duty Couplings.

Import No Hub Coupling



- Manufactured in accordance with CISPI Standard 310
- All stainless construction
- UPC listed



PART NO.	SIZE	CTN/MSTR
U99001	1-1/2"	1/100
U99002	2"	1/100
U99003	3"	1/100
U99004	4"	1/100
U99005	5"	1/40
U99006	6"	1/30
U99008	8"	1/15
U99010	10"	1/12
U99211	2" x 1-1/2"	1/100
U99320	3" x 2"	1/100

Import Heavy Duty No Hub Coupling



- Manufactured in accordance with CISPI Standard 310
- 9/16" stainless steel bands
- Stainless steel housing and shield
- 3/8" stainless steel screws
- 80 inch/lb. installation torque
- UPC listed



PART NO.	DESCRIPTION	CTN/MSTR
U99220	2"	1/75
U99330	3"	1/48
U99440	4"	1/48
U99550	5"	1/15
U99660	6"	1/15
U99880	8"	1/15
U99110	10"	1/10



SECTION T - TUBULAR

Chrome Plated	319-324
Rough Brass.....	325
PVC Plastic	326-328
ABS Plastic	329-331
Bath Wastes.....	332
Lav Drains & Pop Ups.....	333-334
Connectors	335
Basket Strainers.....	336-337
Escutcheons	338

T

Chrome Plated Brass P-Trap



- Zinc nuts
- Shallow escutcheon
- Less cleanout
- UPC listed

PART NO.	SIZE	GAUGE	CTN/MSTR
P38001	1-1/4"	22	1/30
P38002	1-1/4"	20	1/30
P38003	1-1/4"	17	1/30
P38004	1-1/2"	22	1/30
P38005	1-1/2"	20	1/30
P38006	1-1/2"	17	1/30

Chrome Plated Brass P-Trap



- Zinc nuts
- Shallow escutcheon
- With cleanout
- UPC listed

PART NO.	SIZE	GAUGE	CTN/MSTR
P38009	1-1/4"	20	1/30
P38009B (box esc.)	1-1/4"	20	1/30
P38011	1-1/2"	20	1/30

Chrome Plated Brass P-Trap



- Brass nuts
- Shallow escutcheon
- Less cleanout
- UPC listed

PART NO.	SIZE	GAUGE	CTN/MSTR
P38091	1-1/4"	22	1/30
P38007	1-1/4"	20	1/30
P38138	1-1/4" x 1-1/2"	17	1/30
P38092	1-1/4"	17	1/30
P38093	1-1/2"	22	1/30
P38008	1-1/2"	20	1/30
P38094	1-1/2"	17	1/30

Chrome Plated Brass P-Trap



- Brass nuts
- Shallow escutcheon
- With cleanout
- UPC listed

PART NO.	SIZE	GAUGE	CTN/MSTR
P38010	1-1/4"	17	1/30
P38012	1-1/2"	17	1/30

Chrome Plated Brass P-Trap



- Brass nuts
- Box escutcheon
- With cleanout
- UPC listed

PART NO.	SIZE	GAUGE	CTN/MSTR
P38010B	1-1/4"	17	1/30
P38012B	1-1/2"	17	1/30

Chrome Plated Brass P-Trap



- Brass nuts
- Box escutcheon
- Less cleanout
- UPC listed

PART NO.	SIZE	GAUGE	CTN/MSTR
P38003B	1-1/4"	17	1/30
P38005B	1-1/2"	20	1/30
P38006B	1-1/2"	17	1/30

Chrome Plated Brass P-Trap



- Brass nuts
- Semi-cast commercial
- Shallow escutcheon
- With cleanout
- UPC listed

PART NO.	SIZE	GAUGE	CTN/MSTR
J37124	1-1/4"	17	1/30
J37150	1-1/2"	17	1/30

Chrome Plated Brass P-Trap



- Heavy zinc nuts
- Bell escutcheon
- With cleanout
- UPC listed

PART NO.	SIZE	GAUGE	CTN/MSTR
P38002B	1-1/4"	20	1/30

Chrome Plated Brass P-Trap



- Brass nuts
- Bell escutcheon
- Less cleanout
- UPC listed

PART NO.	SIZE	GAUGE	CTN/MSTR
P38150	1-1/4"	17	1/30

Chrome Plated Boston Style P-Trap



- Brass nuts
- Box escutcheon
- With cleanout
- UPC listed



PART NO.	SIZE	GAUGE	CTN/MSTR
P38142	1-1/4" x 1-1/2"	17	1/30

Chrome Plated Brass S-Trap



- Zinc nuts
- Shallow escutcheon
- Less cleanout
- UPC listed



PART NO.	SIZE	GAUGE	CTN/MSTR
P38013	1-1/4"	22	1/15
P38014	1-1/2"	22	1/15

Chrome Plated Milwaukee Style Trap



- Brass nuts
- 10" Arm
- Cast elbow
- With cleanout
- UPC listed



PART NO.	SIZE	GAUGE	CTN/MSTR
P38129	1-1/2"	17	1/30

Chrome Plated Brass S-Trap



- Brass nuts
- Box escutcheon
- Less cleanout
- UPC listed



PART NO.	SIZE	GAUGE	CTN/MSTR
P38095	1-1/4"	20	1/15
P38096	1-1/2"	20	1/15
P38137	1-1/4"	17	1/15
P38097	1-1/2"	17	1/50

Chrome Plated Sink Trap with Sweat Connection



- Brass nuts
- Box escutcheon
- With cleanout
- UPC listed



PART NO.	SIZE	GAUGE	CTN/MSTR
P38140	1-1/2"	17	1/30

Chrome Plated Brass J-Bend



- Heavy zinc nuts
- Slip joint
- Less cleanout
- UPC listed



PART NO.	SIZE	GAUGE	CTN/MSTR
P38015	1-1/4"	22	1/36
P38016	1-1/4"	20	1/36
P38017	1-1/4"	17	1/36
P38018	1-1/2"	22	1/36
P38019	1-1/2"	20	1/36
P38020	1-1/2"	17	1/36

T

Chrome Plated Sink Trap with PVC Adapter



- Brass nuts
- PVC adapter
- Box escutcheon
- With cleanout
- UPC listed



PART NO.	SIZE	GAUGE	CTN/MSTR
P38130	1-1/2"	17	1/20

Chrome Plated Sink Trap with ABS Adapter



- Brass nuts
- ABS adapter
- Box escutcheon
- With cleanout
- UPC listed



PART NO.	SIZE	GAUGE	CTN/MSTR
P38141	1-1/2"	17	1/20



- Captured brass nuts
- Washer joint
- Less cleanout
- UPC listed



PART NO.	SIZE	GAUGE	CTN/MSTR
P38107	1-1/4"	22	1/60
P38108	1-1/4"	20	1/60
P38109	1-1/4"	17	1/60
P38110	1-1/2"	22	1/60
P38111	1-1/2"	20	1/60
P38112	1-1/2"	17	1/60

Chrome Plated Brass J-Bend



- Brass nuts
- Slip joint
- With cleanout
- UPC listed

PART NO.	SIZE	GAUGE	CTN/MSTR
P38021	1-1/4"	17	1/36
P38022	1-1/2"	17	1/36



- Heavy zinc nuts
- Slip joint
- With cleanout
- UPC listed

PART NO.	SIZE	GAUGE	CTN/MSTR
P38113	1-1/4"	20	1/60
P38114	1-1/2"	20	1/60

Chrome Plated Brass L.A. Pattern Sink Trap



- P38099 and P38100 with cast brass elbows
- Brass nuts
- Less cleanout
- UPC listed

PART NO.	SIZE	GAUGE	CTN/MSTR
P38098	1-1/2"	22	1/50
P38099	1-1/2"	20	1/50
P38100	1-1/2"	17	1/50

Chrome Plated Brass Repair Trap



- Brass nuts
- Less cleanout
- UPC listed

PART NO.	SIZE	GAUGE	CTN/MSTR
P38105	1-1/4"	17	1/60
P38106	1-1/2"	17	1/60



- Heavy zinc nuts
- Less cleanout
- UPC listed

PART NO.	SIZE	GAUGE	CTN/MSTR
P38101	1-1/4"	22	1/60
P38102	1-1/4"	20	1/60
P38103	1-1/2"	22	1/60
P38104	1-1/2"	20	1/60

Chrome Plated Brass Slip Joint End Outlet Tee



- Zinc nuts
- 4" Tailpiece
- No baffle
- UPC listed

PART NO.	SIZE	GAUGE	CTN/MSTR
P38023	1-1/2"	22	1/50
P38024	1-1/2"	20	1/50

Chrome Plated Brass Direct Connection End Outlet Waste



- Zinc nuts
- 4" Tailpiece
- No baffle
- UPC listed

PART NO.	SIZE	GAUGE	CTN/MSTR
P38025	1-1/2" x 16"	22	1/20
P38026	1-1/2" x 16"	20	1/20

Chrome Plated Brass Slip Joint End Outlet Waste



- Zinc nuts
- 4" Tailpiece
- No baffle
- UPC listed

PART NO.	SIZE	GAUGE	CTN/MSTR
P38027	1-1/2" x 16"	22	1/20
P38028	1-1/2" x 16"	20	1/20

Chrome Plated Brass Slip Joint Center Outlet Tee



- Zinc nuts
- 4" Tailpiece
- No baffle
- UPC listed

PART NO.	SIZE	GAUGE	CTN/MSTR
P38029	1-1/2"	20	12/120

Chrome Plated Brass Slip Joint Center Outlet Waste



- Zinc nuts
- 4" Tailpiece
- No baffle
- UPC listed

PART NO.	SIZE	GAUGE	CTN/MSTR
P38030	1-1/2" x 16"	22	1/20
P38031	1-1/2" x 16"	20	1/20

Chrome Plated Brass Direct Connection Center Outlet Waste



- Zinc nuts
- 4" Tailpiece
- No baffle
- UPC listed

PART NO.	SIZE	GAUGE	CTN/MSTR
P38032	1-1/2" x 16"	22	1/20
P38033	1-1/2" x 16"	20	10/100

Chrome Plated Brass Slip Joint Waste Arm



- Zinc nut
- Bagged
- UPC listed

PART NO.	SIZE	GAUGE	CTN/MSTR
P38034	1-1/4" x 6"	22	10/100
P38035	1-1/4" x 8"	22	10/50
P38036	1-1/4" x 12"	22	10/50
P38037	1-1/4" x 16"	22	10/50
P38038	1-1/2" x 8"	22	10/100
P38039	1-1/2" x 12"	22	10/50
P38040	1-1/2" x 16"	22	10/50
P38238	1-1/2" x 7"	17	10/50

Chrome Plated Brass Wall Bend



- Bagged
- UPC listed

PART NO.	SIZE	GAUGE	CTN/MSTR
P38041	1-1/4" x 7"	22	10/100
P38042	1-1/4" x 7"	20	10/100
P38115	1-1/4" x 7-1/2"	17	10/100
P38043	1-1/2" x 7-1/2"	22	10/100
P38044	1-1/2" x 7-1/2"	20	10/100
P38116	1-1/2" x 7-1/2"	17	10/100

Chrome Plated Brass Direct Connection Waste Arm



- Bagged
- UPC listed

PART NO.	SIZE	GAUGE	CTN/MSTR
P38045	1-1/2" x 7"	22	10/100
P38117	1-1/2" x 15"	22	10/100
P38217	1-1/2" x 15"	17	1/25

Chrome Plated Brass Slip Joint Double Offset



- Zinc nuts
- Bagged
- UPC listed

PART NO.	SIZE	GAUGE	CTN/MSTR
P38046	1-1/4" x 12"	22	10/100
P38047	1-1/2" x 12"	22	10/50

Chrome Plated Brass Sink Tailpiece



- Bagged
- UPC listed

PART NO.	SIZE	GAUGE	CTN/MSTR
P38048	1-1/4" x 6"	22	10/100
P38049	1-1/4" x 8"	22	10/100
P38050	1-1/4" x 12"	22	10/100
P38051	1-1/4" x 6"	17	10/100
P38052	1-1/4" x 8"	17	10/100
P38053	1-1/4" x 12"	17	10/50
P38054	1-1/2" x 4"	22	10/100
P38055	1-1/2" x 6"	22	10/100
P38056	1-1/2" x 8"	22	10/100
P38057	1-1/2" x 12"	22	10/50
P38058	1-1/2" x 6"	17	10/100
P38059	1-1/2" x 8"	17	10/100
P38060	1-1/2" x 12"	17	10/50

Chrome Plated Brass Double Flange Tailpiece



- Bagged
- UPC listed

PART NO.	SIZE	GAUGE	CTN/MSTR
P38061	1-1/2" x 16"	22	10/50

Chrome Plated Brass Double Slip Joint Extension Tube



- Zinc nuts
- Bagged
- UPC listed



PART NO.	SIZE	GAUGE	CTN/MSTR
P38062	1-1/2" x 16"	22	10/50
P38162	1-1/4" x 16"	22	10/50

Chrome Plated Brass Slip Joint Extension Tube



- Zinc nut
- Bagged
- UPC listed



PART NO.	SIZE	GAUGE	CTN/MSTR
P38065	1-1/4" x 6"	22	10/100
P38066	1-1/4" x 8"	22	10/100
P38067	1-1/4" x 12"	22	10/50
P38121	1-1/4" x 6"	20	10/100
P38122	1-1/4" x 8"	20	10/100
P38068	1-1/4" x 12"	20	10/50
P38118	1-1/4" x 6"	17	10/100
P38119	1-1/4" x 8"	17	10/100
P38120	1-1/4" x 12"	17	10/50
P38069	1-1/2" x 6"	22	10/100
P38070	1-1/2" x 8"	22	10/100
P38071	1-1/2" x 12"	22	25/50
P38123	1-1/2" x 6"	20	10/100
P38124	1-1/2" x 8"	20	10/100
P38125	1-1/2" x 12"	20	10/50
P38126	1-1/2" x 6"	17	10/100
P38127	1-1/2" x 8"	17	10/100
P38128	1-1/2" x 12"	17	10/50

Chrome Plated Brass Solder Extension Tube



- UPC listed



PART NO.	SIZE	GAUGE	CTN/MSTR
P38072	1-1/4" x 6"	22	10/100
P38073	1-1/4" x 8"	22	10/100
P38074	1-1/4" x 12"	22	10/100
P38131	1-1/4" x 6"	20	10/100
P38132	1-1/4" x 8"	20	10/100
P38133	1-1/4" x 12"	20	10/100
P38075	1-1/2" x 6"	22	10/100
P38076	1-1/2" x 8"	22	10/100
P38077	1-1/2" x 12"	22	10/100
P38134	1-1/2" x 6"	20	10/100
P38135	1-1/2" x 8"	20	10/100
P38136	1-1/2" x 12"	20	10/100

Chrome Plated Brass Threaded Extension Tube



- Bagged
- Threaded on both ends
- UPC listed



PART NO.	SIZE	GAUGE	CTN/MSTR
P38078	1-1/4" x 6"	20	10/100
P38079	1-1/4" x 8"	20	10/100
P38080	1-1/4" x 12"	20	10/50
P38081	1-1/2" x 6"	20	10/100
P38082	1-1/2" x 8"	20	10/100
P38083	1-1/2" x 12"	20	10/50
P38084	1-1/4" x 6"	17	10/100
P38085	1-1/4" x 8"	17	10/100
P38086	1-1/4" x 12"	17	10/50
P38087	1-1/2" x 6"	17	10/100
P38088	1-1/2" x 8"	17	10/50
P38089	1-1/2" x 12"	17	10/50

Chrome Plated Brass Direct Connect Dishwasher Tailpiece



- Zinc nut
- Bagged
- UPC listed

PART NO.	SIZE	GAUGE	CTN/MSTR
P38063	1-1/2" x 6" with 3/4" branch	22	10/100
P38064	1-1/2" x 8" with 3/4" branch	22	10/50
P38163	1-1/2" x 6" with 1/2" branch	22	5/30
P38148	1-1/2" x 8" with 1/2" branch	22	10/100

Chrome Plated Disposer Kit



- Zinc nuts
- UPC listed

PART NO.	SIZE	GAUGE	CTN/MSTR
P38165	1-1/2" x 13"	17	1/20

Chrome Plated Threaded Connection Dishwasher Tailpiece



- UPC listed

PART NO.	SIZE	GAUGE	CTN/MSTR
P38166	1-1/2" x 6" with 1/2" branch	22	1/50

Chrome Plated Slip Joint Tee



- Zinc nuts
- Chrome plated satin finish cast brass

PART NO.	SIZE	CTN/MSTR
C74105	1-1/2" x 1-1/2" x 1-1/2"	10/60

Chrome Plated Slip Joint Dishwasher Tailpiece



- Zinc nut
- Bagged
- UPC listed

PART NO.	SIZE	GAUGE	CTN/MSTR
P38164	1-1/2" x 8" with 3/4" branch	22	10/50
P38143	1-1/2" x 8" with 1/2" branch	22	10/50

Chrome Plated Double Slip Fittings



- Zinc nuts
- Chrome plated brass
- 22 gauge

PART NO.	DESCRIPTION	SIZE	CTN/MSTR
T74001	Coupling	1-1/4"	10/100
T74002	Coupling	1-1/2"	10/100
T74003	90° Elbow	1-1/4"	10/100
T74004	90° Elbow	1-1/2"	10/100
T74005	45° Elbow	1-1/4"	10/100
T74006	45° Elbow	1-1/2"	10/100

Chrome Plated Closet Flush Elbow



- Includes rubber slip joint washers
- Zinc nuts
- Bagged
- UPC listed

PART NO.	SIZE	GAUGE	CTN/MSTR
P38257	2" x 5" x 7"	20	1/25

Items marked with the Jones Stephens logo are "You Need It... We Got It" Items.

Rough Brass P-Trap



- Brass nuts
- Deep flange
- Less cleanout
- UPC listed



PART NO.	SIZE	GAUGE	CTN/MSTR
P38406	1-1/2"	17	1/30

Rough Brass Direct Connection Waste Arm



- UPC listed



PART NO.	SIZE	GAUGE	CTN/MSTR
P38444	1-1/2" x 7"	17	1/100
P38447	1-1/2" x 15"	17	1/50

Rough Brass Flanged Tailpiece



- UPC listed



PART NO.	SIZE	GAUGE	CTN/MSTR
P38454	1-1/2" x 4"	17	10/50
P38458	1-1/2" x 6"	17	10/100
P38459	1-1/2" x 8"	17	10/100
P38460	1-1/2" x 12"	17	10/50

Rough Brass Slip Joint Tailpiece with 1/2" Sweat Branch



- Brass nut
- UPC listed



PART NO.	SIZE	GAUGE	CTN/MSTR
P38443	1-1/2" x 8"	17	1/50

Rough Brass Slip Joint Extension Tube



- Brass nut
- UPC listed



PART NO.	SIZE	GAUGE	CTN/MSTR
P38420	1-1/4" x 12"	17	10/50
P38428	1-1/2" x 12"	17	10/50

Rough Brass Double Threaded Extension Tube



- UPC listed



PART NO.	SIZE	GAUGE	CTN/MSTR
P38486	1-1/4" x 12"	17	10/100
P38489	1-1/2" x 12"	17	10/100

Rough Brass Bath Waste and Overflow Kit



- Full kit
- Chrome plated brass drain
- Die cast face plate

PART NO.	GAUGE	DESCRIPTION	# HOLES	CTN/MSTR
B07310	20	1-3/8" with chain and stopper	2	1/12
B07311	20	1-1/2" with chain and stopper	2	1/10



- Full kit
- Chrome plated brass drain
- Die cast face plate

PART NO.	GAUGE	DESCRIPTION	# HOLES	CTN/MSTR
B07312	20	1-1/2" with trip lever	2	1/12

T

PVC P-Trap



• UPC listed



PART NO.	SIZE	CTN/MSTR
P37001	1-1/4"	25/100
P37002	1-1/2"	10/50

PVC P-Trap with Solvent Weld Marvel



• Master trap
• UPC listed



PART NO.	SIZE	CTN/MSTR
P37003	1-1/2" slip joint	25/50
P37032	1-1/2" solvent weld	10/100

PVC Slip Joint Center Outlet Waste



• Baffle tee
• UPC listed



PART NO.	SIZE	CTN/MSTR
P37004	1-1/2"	10/40

T PVC Direct Connection Center Outlet Waste



• Baffle tee
• UPC listed



PART NO.	SIZE	CTN/MSTR
P37005	1-1/2"	10/40

PVC Center Outlet Tee



• Baffle
• Tailpiece included
• May be used as slipjoint or direct connect
• UPC listed



PART NO.	SIZE	CTN/MSTR
P37006	1-1/2"	25/100

PVC Slip Joint End Outlet Waste



• Baffle
• UPC listed



PART NO.	SIZE	CTN/MSTR
P37007	1-1/2" x 16"	10/40
P37034	1-1/2" x 16" Adjustable arm	10/40

PVC Slip Joint End Outlet Waste



• 1/2" branch
• Adjustable arm
• With dishwasher tailpiece
• UPC listed



PART NO.	SIZE	CTN/MSTR
P37042	1-1/2"	10/40

PVC Direct Connection End Outlet Waste



• Baffle
• UPC listed



PART NO.	SIZE	CTN/MSTR
P37008	1-1/2"	10/50
P37036	1-1/2" telescoping	10/50

PVC Slip Joint End Outlet Tee Only with Baffle



• Baffle
• UPC listed



PART NO.	SIZE	CTN/MSTR
P37009	1-1/2"	25/100

PVC Slip Joint S-Trap



• UPC listed



PART NO.	SIZE	CTN/MSTR
P37010	1-1/4"	15/60
P37011	1-1/2"	15/60

PVC Slip Joint Dishwasher Tailpiece



• UPC listed



PART NO.	SIZE	CTN/MSTR
P37012	1-1/2" x 8" x 1/2"	1/25
P37030	1-1/2" x 8" x 3/4"	5/25

PVC Direct Connection Dishwasher Tailpiece



• May be used as slip joint or direct connect
• UPC listed



PART NO.	SIZE	CTN/MSTR
P37013	1-1/2" x 8" x 1/2"	5/25
P37031	1-1/2" x 8" x 3/4"	5/25

PVC Universal End Outlet Waste with Dishwasher Connection



• 1-1/2" tubular; 16" maximum adjustment
• Baffle tee
• May be used as slip joint or direct connect
• UPC listed



PART NO.	SIZE	CTN/MSTR
P37040	1/2" branch	10/60
P37041	3/4" branch	10/60

PVC Slip Joint Repair Trap



• UPC listed



PART NO.	SIZE	CTN/MSTR
P37014	1-1/2"	1/80

PVC Slip Joint J-Bend



• UPC listed



PART NO.	SIZE	CTN/MSTR
P37015	1-1/2"	10/60

PVC Slip Joint Waste Arm



• UPC listed



PART NO.	SIZE	CTN/MSTR
P37016	1-1/2" x 16"	25/100

PVC Direct Connection Waste Arm



• UPC listed



PART NO.	SIZE	CTN/MSTR
P37017	1-1/2" x 16"	10/100

PVC Slip Joint Extension Tube



• UPC listed



PART NO.	SIZE	CTN/MSTR
P37018	1-1/2" x 16"	25/50
P37118	1-1/4" x 16"	10/100

PVC Double Flange Extension



• UPC listed



PART NO.	SIZE	CTN/MSTR
P37019	1-1/2" x 16"	25/100

PVC Slip Joint Extension Tube



• UPC listed



PART NO.	SIZE	CTN/MSTR
P37020	1-1/4" x 6"	25/100
P37021	1-1/2" x 8"	25/100
P37022	1-1/2" x 12"	25/100

PVC Solvent Extension Tube



• UPC listed



PART NO.	SIZE	CTN/MSTR
P37023	1-1/4" x 8"	25/100
P37024	1-1/2" x 6"	25/100
P37025	1-1/2" x 12"	25/100

PVC Flanged Tailpiece



• UPC listed



PART NO.	SIZE	CTN/MSTR
P37026	1-1/2" x 6"	25/200
P37027	1-1/2" x 8"	25/200
P37028	1-1/2" x 12"	25/200
P37029	1-1/2" x 16"	25/100

PVC Direct Connection Disposer Kit with 13" Arm



- Poly washers and wing nuts
- Disposer washer
- Baffle tee
- 6" Tailpiece
- UPC listed



PART NO.	SIZE	CTN/MSTR
P37033	1-1/2" x 16"	10/50

PVC Slip Joint Double Offset Tailpiece



- Slip joint on both ends
- UPC listed



PART NO.	SIZE	CTN/MSTR
P37150	1/2"	1/40

1-1/2" PVC Direct Connection Disposer Kit with Adjustable Arm



- Telescoping arm adjusts up to 16"
- Poly washers and wing nuts
- Disposer washer
- Baffle tee
- 6" tailpiece

PART NO.	SIZE	CTN/MSTR
P37035	1-1/2" x 16"	10/40

PVC Slip Joint Tee



PART NO.	SIZE	CTN/MSTR
P37400	1-1/2" with 1-1/4" washer	120

PVC Double Slip Fittings



PART NO.	DESCRIPTION	SIZE	CTN/MSTR
P37200	Coupling	1-1/2"	10/100
P37445	45° Elbow	1-1/2"	1/100
P37490	90° Elbow	1-1/2"	1/100

T

Chrome Plated PVC P-Trap



- Complete with nuts, washers, and box escutcheon
- P36103 includes reducing washer

PART NO.	SIZE	CTN/MSTR
P36102	1-1/4"	1/50
P36103	1-1/2"	1/50

ABS P-Trap



- UPC listed



PART NO.	SIZE	CTN/MSTR
P39001	1-1/4"	10/100
P39002	1-1/2"	10/50

ABS P-Trap with Adapter



- Master trap
- UPC listed



PART NO.	SIZE	CTN/MSTR
P39003	1-1/2" slip joint	1/50
P39032	1-1/2" solvent weld	10/50

ABS Slip-Joint Center Outlet Waste



- UPC listed



PART NO.	SIZE	CTN/MSTR
P39004	1-1/2"	10/40

ABS Direct Connection Center Outlet Waste



- Tailpiece included
- May be used as slip joint or direct connect
- UPC listed



PART NO.	SIZE	CTN/MSTR
P39005	1-1/2"	10/40

ABS Slip-Joint Center Outlet Tee



- UPC listed



PART NO.	SIZE	CTN/MSTR
P39006	1-1/2"	10/100

ABS Slip-Joint End Outlet Waste



- Baffle
- UPC listed



PART NO.	SIZE	CTN/MSTR
P39007	1-1/2" x 16"	20/40
P39034	1-1/2" x 16" adjustable	10/40

ABS Direct Connection End Outlet Waste



- Baffle
- UPC listed



PART NO.	SIZE	CTN/MSTR
P39008	1-1/2"	20/40

ABS Slip Joint End Outlet Tee



- UPC listed



PART NO.	SIZE	CTN/MSTR
P39009	1-1/2"	25/100

ABS S-Trap



- UPC listed



PART NO.	SIZE	CTN/MSTR
P39010	1-1/4"	15/60
P39011	1-1/2"	15/60

ABS Slip Joint Dishwasher Tailpiece



• UPC listed



PART NO.	SIZE	CTN/MSTR
P39012	1-1/2" x 8" x 1/2"	5/25
P39030	1-1/2" x 8" x 3/4"	5/25

ABS Direct Connection Dishwasher Tailpiece



• UPC listed



PART NO.	SIZE	CTN/MSTR
P39013	1-1/2" x 8" x 1/2"	5/25
P39031	1-1/2" x 8" x 3/4"	5/25

ABS Slip Joint Repair Trap



• UPC listed



PART NO.	SIZE	CTN/MSTR
P39014	1-1/2"	20/80

ABS Slip Joint J-Bend



• UPC listed



PART NO.	SIZE	CTN/MSTR
P39015	1-1/2"	20/80

ABS Slip Joint Waste Arm



• UPC listed



PART NO.	SIZE	CTN/MSTR
P39016	1-1/2" x 16"	25/100

ABS Direct Connection Waste Arm



• UPC listed



PART NO.	SIZE	CTN/MSTR
P39017	1-1/2" x 16"	25/100

ABS Slip Joint Extension Tube



• UPC listed



PART NO.	SIZE	CTN/MSTR
P39018	1-1/2" x 16"	10/50

ABS Double Flange Extension



• UPC listed



PART NO.	SIZE	CTN/MSTR
P39019	1-1/2" x 16"	25/100

ABS Slip Joint Extension Tube



• UPC listed



PART NO.	SIZE	CTN/MSTR
P39020	1-1/4" x 6"	10/100
P39021	1-1/2" x 8"	10/100
P39022	1-1/2" x 12"	25/100

1-1/2" ABS Direct Connection Disposer Kit



- Poly washer and wing nuts
- Disposer washer
- 6" Tailpiece
- UPC listed



PART NO.	SIZE	CTN/MSTR
P39033	1-1/2" x 16"	10/50

T

1-1/2" ABS Direct Connection Disposer Kit with Adjustable Arm



- Baffle tee
- 6" Tailpiece
- Disposer washer
- Poly washers and wing nuts
- Telescoping arm adjusts up to 16"
- UPC listed

PART NO.	SIZE	CTN/MSTR
P39035	1-1/2" x 16"	1/40

ABS Universal End Outlet Waste with Dishwasher Connection



- 1-1/2" tubular; 16" maximum adjustment
- Slip joint or direct connection
- Baffle tee
- UPC listed

PART NO.	SIZE	CTN/MSTR
P39040	1/2" branch	10/40
P39041	3/4" branch	10/40

ABS Solvent Extension Tube



- UPC listed

PART NO.	SIZE	CTN/MSTR
P39023	1-1/4" x 8"	25/100
P39024	1-1/2" x 6"	25/100
P39025	1-1/2" x 12"	25/100

ABS Flanged Tailpiece



- UPC listed

PART NO.	SIZE	CTN/MSTR
P39026	1-1/2" x 6"	25/200
P39027	1-1/2" x 8"	25/200
P39028	1-1/2" x 12"	25/200
P39029	1-1/2" x 16"	25/100

Chrome Plated ABS P-Trap



- Slip joint connection
- Box escutcheon
- UPC listed

PART NO.	SIZE	CTN/MSTR
P36104	1-1/4"	10/50
P36105	1-1/2"	10/50

PVC and ABS Tubular Bath Waste Kits

- Heavy walled PVC and ABS tubular
- Available in CP and PVD protected SN
- 2-hole face plates with wrap-around gaskets and tapped holes
- 1-1/2" IPS threaded drain shoe
- Overflow elbow designed to accommodate B07202 test kit
- Wing nuts and poly washers
- Boxed
- UPC listed



1-1/2" Lift and Turn Bath Waste Tubular Kit



PART NO.	FINISH	FACE PLATE	MATERIAL	CTN/MSTR
P37500	CP	2-hole	PVC	1/20
P39500	CP	2-hole	ABS	1/20
P37502	SN (PVD)	2-hole	PVC	1/20
P39502	SN (PVD)	2-hole	ABS	1/20

1-1/2" Brass Friction Lift Bath Waste Tubular Kit



PART NO.	FINISH	FACE PLATE	MATERIAL	CTN/MSTR
P37503	CP	2-hole	PVC	1/20
P39503	CP	2-hole	ABS	1/20
P37505	SN (PVD)	2-hole	PVC	1/20
P39505	SN (PVD)	2-hole	ABS	1/20

1-1/2" Brass Toe Touch Bath Waste Tubular Kit



PART NO.	FINISH	FACE PLATE	MATERIAL	CTN/MSTR
P37506	CP	2-hole	PVC	1/20
P39506	CP	2-hole	ABS	1/20
P37508	SN (PVD)	2-hole	PVC	1/20
P39508	SN (PVD)	2-hole	ABS	1/20

1-1/2" Trip Lever Bath Waste Tubular Kit



PART NO.	FINISH	FACE PLATE	MATERIAL	CTN/MSTR
P37509	CP	2-hole	PVC	1/20
P39509	CP	2-hole	ABS	1/20
P37511	SN (PVD)	2-hole	PVC	1/20
P39511	SN (PVD)	2-hole	ABS	1/20

PVC and ABS Tubular Cable Drive Bath Waste 1/2 Kits

- Available in CP and PVD protected SN
- 1-1/2" IPS threaded drain shoe
- UPC listed



1-1/2"- 27" Cable Drive

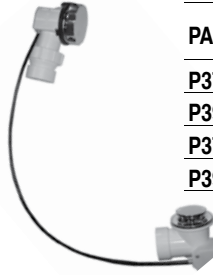

PART NO.	FINISH	MATERIAL	CTN/MSTR
P37512	CP	PVC	1/20
P39512	CP	ABS	1/20
P37514	SN (PVD)	PVC	1/20
P39514	SN (PVD)	ABS	1/20

1-1/2"- 35" Cable Drive



PART NO.	FINISH	MATERIAL	CTN/MSTR
P37515	CP	PVC	1/20
P39515	CP	ABS	1/20
P37517	SN (PVD)	PVC	1/20
P39517	SN (PVD)	ABS	1/20

1-1/2"- 45" Cable Drive



PART NO.	FINISH	MATERIAL	CTN/MSTR
P37518	CP	PVC	1/20
P39518	CP	ABS	1/20
P37520	SN (PVD)	PVC	1/20

T

Commercial Lav Grid Drain



- Polished chrome plated brass
- Mack washer and brass locknut
- 17 Gauge 1-1/4" tailpiece; 6" long

PART NO.	DESCRIPTION	CTN/MSTR
D70100	Commercial lav drain	1/50

Handicap Style Lav Grid Drain



- Polished chrome plated brass
- Twin 90° construction
- 17 Gauge 1-1/4" tailpiece; cast brass elbows
- Mack washer and brass locknut
- UPC listed

PART NO.	DESCRIPTION	CTN/MSTR
D70101	Handicap style lav grid drain	1/25

Commercial Handicap Style Lav Grid Drain with Elbow



- Polished chrome plated brass; cast brass elbow
- 1-1/4" female thread
- Complete with gaskets and brass locknut

PART NO.	DESCRIPTION	CTN/MSTR
D70102	Handicap style lav grid drain with elbow	1/48

Chrome Plated Brass Pop-Up Assembly



- All metal construction
- Tool free locknut and ballrod nut
- With overflow holes
- Boxed

PART NO.	DESCRIPTION	CTN/MSTR
P35001	CP pop-up assembly	1/50

Polished Brass Pop-Up Assembly

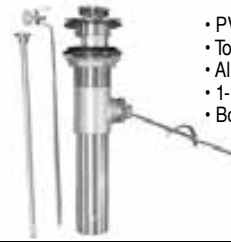

- PVD durable finish
- Tool free locknut and ballrod nut
- All metal construction
- 1-1/4" Tubular
- Boxed

PART NO.	DESCRIPTION	CTN/MSTR
P35002	PB (PVD) pop-up assembly	1/50

ABS Lav Pop-Up Assembly



- Carded

PART NO.	DESCRIPTION	CTN/MSTR
P35004	Grey plastic	1/30

Chrome Plated ABS Lav Pop-Up Assembly



- Carded

PART NO.	DESCRIPTION	CTN/MSTR
P35005	Chrome plated plastic	1/30

Brass P.O. Plug Lav Drain



- With chain and stopper

PART NO.	DESCRIPTION	CTN/MSTR
D70103	P.O. plug drain	1/50

Chrome Plated Trap Primer Tailpiece



- 17 Gauge tubular chrome plated steel
- Sturdy one-piece construction eliminates leaks and cross-threading

PART NO.	SIZE	CTN/MSTR
T74010	1-1/4" x 8" threaded top	1/50
T74011	1-1/2" x 8" direct connection	1/50

Plastic Slip Joint Nut



- White
- CARTON QUANTITIES ONLY

PART NO.	SIZE	CTN/MSTR
T83150	1-1/2" with wings	100/1200
T85125	1-1/4" x 1-1/4"	100/1200
T85150	1-1/2" x 1-1/2"	100/1200

Plastic Slip Nut



- Replace fractured or stripped slip nuts without tubular disassembly
- Supplied with washer

PART NO.	SIZE	CTN/MSTR
T82125	1-1/4" Split nut	100/400
T82150	1-1/2" Split nut	100/400

Chrome Plated Die Cast Zinc Slip Joint Nut



- Chrome plated
- CARTON QUANTITIES ONLY

PART NO.	IPS x SLIP TUBE	CTN/MSTR
T77125	1-1/4" x 1-1/4"	25/500
T77138	1-1/2" x 1-3/8"	400/800
T77150	1-1/2" x 1-1/2"	25/300
T77151	1-1/2" x 1-1/4"	25/300
T77152	2" x 1-1/2"	25/300
T77200	2" x 2"	25/200

Chrome Plated Brass Slip Joint Nut



- Chrome plated
- CARTON QUANTITIES ONLY

PART NO.	IPS x SLIP TUBE	CTN/MSTR
T78125	1-1/4" x 1-1/4"	200/400
T78150	1-1/2" x 1-1/2"	200/400
T78151	1-1/2" x 1-1/4"	200/400
T78152	2" x 1-1/2"	125/250
T78200	2" x 2"	25/250

Rough Brass Slip Joint Nut



- Heavy cast brass
- CARTON QUANTITIES ONLY

PART NO.	IPS x SLIP TUBE	CTN/MSTR
T84125	1-1/4" x 1-1/4"	25/300
T84150	1-1/2" x 1-1/2"	25/300
T84151	1-1/2" x 1-1/4"	25/300
T84200	2" x 2"	25/300

Chrome Plated Die Cast Slip Joint Nut and Washer



- Chrome plated nut packed with square cut rubber washer
- CARTON QUANTITIES ONLY

PART NO.	SIZE	CTN/MSTR
T77014	1-1/4" x 1-1/4"	25/500
T77012	1-1/2" x 1-1/2"	25/500
T77013	1-1/2" x 1-1/4"	25/500
T77020	2" x 2"	25/500

Chrome Plated Brass Slip Joint Nut and Washer



- Chrome plated nut packed with square cut rubber washer
- CARTON QUANTITIES ONLY

PART NO.	SIZE	CTN/MSTR
T78014	1-1/4" x 1-1/4"	25/400
T78012	1-1/2" x 1-1/2"	200/400
T78013	1-1/2" x 1-1/4"	200/400
T78020	2" x 2"	25/400

Square Cut Rubber Slip Joint Washer



• CARTON QUANTITIES ONLY

PART NO.	NUT x TUBE	CTN/MSTR
T79125	1-1/4" x 1-1/4"	100/5600
T79150	1-1/2" x 1-1/2"	100/5600
T79151	1-1/2" x 1-1/4"	100/5600
T79200	2" x 2"	100/2400
T79201	2" x 1-1/2"	100/2400
T79152	1-1/2" x 1-1/4" cloth inserted	100/1000

Poly Beveled Slip Joint Washer



• CARTON QUANTITIES ONLY

PART NO.	NUT x TUBE	CTN/MSTR
T80125	1-1/4" x 1-1/4"	100/5000
T80150	1-1/2" x 1-1/2"	100/5000
T80200	2" x 2"	100/5000

LDP Blue Slip Joint Washer



• CARTON QUANTITIES ONLY

PART NO.	NUT x TUBE	CTN/MSTR
T80135	1-1/4" x 1-1/4"	100/5000
T80160	1-1/2" x 1-1/2"	100/5000
T80151	1-1/2" x 1-1/4"	100/5000

Flanged Poly Tailpiece Washer



• CARTON QUANTITIES ONLY

PART NO.	NUT x TUBE	CTN/MSTR
T81150	1-1/2" x 1-1/2"	100/5000
T79152	1-1/2" x 1-1/4" cloth inserted	100/5000

Marvel Ring



• Use on closet/urinal stub out adapter

PART NO.	FSWT x MIP	CTN/MSTR
B55004	1-1/4" SJ x 1-1/4" SWT	1/1000
B55005	1-1/2" SJ x 1-1/2" SWT	1/500
B55006	2" SJ x 2" SWT	1/500
B55007	1-1/2" SJ x 1-1/4" SWT	1/500

PVC Marvel Adapter



• Thread x Hub

PART NO.	SIZE	CTN/MSTR
P37000	1-1/2" PVC	1/100
P39000	1-1/2" ABS	1/100

Tray Plug



- Stainless steel body with die cast locknut
- Fits 1-1/2" bar sink
- Complete with washers and stopper

PART NO.	DESCRIPTION	CTN/MSTR
B02051	Tray plug	1/100

FIP x SLIP Waste Connector



- Brass body ferrule and nut; OD is copper tubular dimension
- MIP units are combination female sweat
- With stop

PART NO.	FIP x OD	CTN/MSTR
T75125	1-1/4" x 1-1/4"	12/72
T75150	1-1/2" x 1-1/2"	12/72
T75151	1-1/2" x 1-1/4"	12/72

MIP x SLIP Waste Connector



- Brass body ferrule and nut; OD is copper tubular dimension
- MIP units are combination female sweat
- With stop

PART NO.	MIP x OD	CTN/MSTR
T76125	1-1/4" x 1-1/4"	12/72
T76150	1-1/2" x 1-1/2"	12/72
T76151	1-1/2" x 1-1/4"	12/72

Flexible Trap Drain Connector



PART NO.	DESCRIPTION	CTN/MSTR
T06001	Connects 1-1/4" - 1-1/2" tubular to 1-1/4" - 1-1/2" tubular	1/180
T06002	Connects 1" DWV or 1-1/2" CTS to 1-1/4" - 1-1/2" tubular	1/100
T06003	Connects 1-1/2" DWV or CTS to 1-1/4" - 1-1/2" tubular	1/100
T06004	Connects 2" DWV to 1-1/4" - 1-1/2" tubular	1/100

Duo Basket Strainer



- 4-1/2" diameter to fit 3-1/2" drilling
- All stainless steel with zinc locknut
- Basket with rolled edge
- UPC listed



PART NO.	DESCRIPTION	CTN/MSTR
S14001	SS duo basket strainer	1/50

Snap Lock Basket Strainer



- 4-1/2" diameter to fit 3-1/2" drilling
- All stainless steel with zinc locknut
- Ball bearing basket with rolled edge (less tailpiece)
- UPC listed



PART NO.	DESCRIPTION	CTN/MSTR
S14005	Snap lock basket strainer	1/50

Flat Top Grid Strainer



- 4-1/2" diameter to fit 3-1/2" drilling
- All stainless steel with zinc locknut (less tailpiece)
- UPC listed



PART NO.	DESCRIPTION	CTN/MSTR
S14002	Flat top grid strainer	1/24

Shallow Cup Duo Basket Strainer



- 4-1/2" diameter to fit 3-1/2" drilling
- All stainless steel with zinc locknut
- Basket with rolled edge (less tailpiece)
- UPC listed



PART NO.	DESCRIPTION	CTN/MSTR
S14006	Shallow cup duo strainer	1/50

Twist & Lock Basket Strainer



- 4-1/2" diameter to fit 3-1/2" drilling
- Screw-in basket (less tailpiece)
- UPC listed



PART NO.	DESCRIPTION	CTN/MSTR
S14003	Twist & lock basket strainer	1/50
S14103	Replacement basket	10/200

Stainless Steel Duo Basket Strainer



- Stainless steel body and basket
- Neoprene stopper
- Spring style snap-in basket
- UPC listed



PART NO.	DESCRIPTION	CTN/MSTR
S14606	SS duo basket strainer	1/50

T Stainless Steel Duo Post Style Basket Strainer



- Stainless steel body and basket
- Polished inner cup
- Compare to JB250SS
- CP zinc post and slip nut
- Heavy duty rubber gasket and zinc locknut
- UPC listed



PART NO.	DESCRIPTION	CTN/MSTR
S14251	SS Duo post style basket strainer	1/50

Chrome Plated Brass Duo Basket Strainer



- Beveled stopper w/o-ring seal
- Brass slip joint nut and lock nut
- Compare to Kohler K8801

PART NO.	DESCRIPTION	CTN/MSTR
S14007	CP brass duo basket strainer	1/25

Deep Cup Basket Strainer



- 4-1/2" diameter to fit 3-1/2" drilling
- All stainless steel with zinc locknut
- Basket with rolled edge (less tailpiece)
- UPC listed



PART NO.	DESCRIPTION	CTN/MSTR
S14004	Deep cup basket strainer	1/50

Chrome Plated Brass Duo Basket Strainer



- Chrome plated brass body with stainless steel basket
- Heavy duty construction
- Neoprene stopper
- UPC listed



PART NO.	DESCRIPTION	CTN/MSTR
S14250	CP brass duo basket strainer	1/50

Quick Fit Stainless Steel Basket Strainer



- Minimizes installation time
- Triangle frame mounts to underside
- Fits virtually all sinks
- Durable stainless construction with brass nut
- For replacement basket use B03015
- UPC listed



PART NO.	DESCRIPTION	CTN/MSTR
S14008	SS basket strainer	1/50

Economy Replacement Basket Strainer



- ABS post
- Stainless steel basket

PART NO.	DESCRIPTION	CTN/MSTR
B03015	Replacement basket strainer	10/200

Stainless Steel Deep Cup Basket Strainer



- Stainless steel body and basket
- Neoprene stopper
- Spring style snap-in basket
- UPC listed



PART NO.	DESCRIPTION	CTN/MSTR
S14014	SS cup basket strainer	1/50

Fit-All Basket Strainer



- Stainless steel

PART NO.	DESCRIPTION	CTN/MSTR
B03010	Fit-all basket strainer	20/200

Junior Duo Basket Strainer



- Stainless steel body and basket with die cast locknut; 1-1/2" threads
- Complete with washers
- Fits 1-3/4" bar sink

PART NO.	DESCRIPTION	CTN/MSTR
B02050	Junior duo basket strainer	1/100
B02049	Replacement basket	100/500

Snap N Lock Stainless Steel Basket Strainer



- Brass slip joint and lock nuts

PART NO.	DESCRIPTION	CTN/MSTR
S14010	Snap N Lock stainless steel basket strainer	1/50

Flat Duplex Strainer



- Stainless steel body and strainer with die cast locknut
- Complete with washers
- Fits 1-3/4" bar sink

PART NO.	DESCRIPTION	CTN/MSTR
B02052	Flat duplex strainer	1/100

Chrome Plated ASAP Basket Strainer



- Durable stainless construction with brass slip nut
- Ideal for quick installation
- Can be installed in less than one minute
- Galvanized retaining ring
- Galvanized locking ring

PART NO.	DESCRIPTION	CTN/MSTR
S14009	ASAP basket strainer	1/24

Deep Junior Duo Basket Strainer



- For 2" and 2-1/2" deep outlets and bar sinks

PART NO.	DESCRIPTION	CTN/MSTR
B02102	2" Deep basket strainer	1/100
B02103	Replacement basket	1/250

Low Pattern Tubular Sure Grip Escutcheon



- Chrome plated steel
- CARTON QUANTITIES ONLY

PART NO.	SIZE	FLANGE OD	CTN/MSTR
E03125	1-1/4" Tubular	2-7/8"	25/1200
E03150	1-1/2" Tubular	2-7/8"	25/1200
E03200	2" Tubular	3-1/2"	25/400

Box Pattern Tubular Sure Grip Escutcheon



- Chrome plated steel
- CARTON QUANTITIES ONLY

PART NO.	SIZE	FLANGE OD	CTN/MSTR
E04125	1-1/4" Tubular	3"	5/300
E04150	1-1/2" Tubular	3"	5/300
E04200	2" Tubular	3"	5/300

PVC DWV FITTINGS 341-347

**PVC
DWV**

*Published March 2017. List prices can be found in list price book and on our website.

Coupling

H x H



- Used to join straight lengths of pipe

PART NO.	SIZE	CTN/MSTR
PFC114	1-1/4"	1/100
PFC115	1-1/2"	1/100
PFC120	2"	1/100
PFC130	3"	1/60
PFC140	4"	1/25
PFC160	6"	1/15

Repair Coupling

H x H



- Furnished without center stop so that stationary lengths of pipe can be spliced together

PART NO.	SIZE	CTN/MSTR
PFC116	1-1/2"	1/25
PFC122	2"	1/25
PFC133	3"	1/10
PFC144	4"	1/5

Reducer Coupling

H x H



- Used to reduce or increase pipe sizes

PART NO.	SIZE	CTN/MSTR
PFC121	2" x 1-1/2"	1/25
PFC131	3" x 1-1/2"	1/25
PFC132	3" x 2"	1/20
PFC142	4" x 2"	1/10
PFC143	4" x 3"	1/20

Flush Bushing

Spg x H



- Inserts into fitting hub to reduce to smaller pipe sizes

PART NO.	SIZE	CTN/MSTR
PFB211	1-1/2" x 1-1/4"	1/50
PFB221	2" x 1-1/2"	1/100
PFB231	3" x 1-1/2"	1/20
PFB232	3" x 2"	1/30
PFB242	4" x 2"	1/30
PFB243	4" x 3"	1/30
PFB264	6" x 4"	1/10

Male Adapter

H x MPT



- Adapts to standard female pipe threads
- Teflon thread tape is recommended for threaded joints

PART NO.	SIZE	CTN/MSTR
PMA414	1-1/4"	1/50
PMA415	1-1/2"	1/50
PMA420	2"	1/50
PMA430	3"	1/25
PMA440	4"	1/25

Female Adapter

H x FPT



- Adapts to standard male pipe threads
- Teflon thread tape is recommended for threaded joints

PART NO.	SIZE	CTN/MSTR
PFA314	1-1/4"	1/100
PFA315	1-1/2"	1/100
PFA311	1-1/2" x 1-1/4"	1/100
PFA320	2"	1/100
PFA330	3"	1/30
PFA340	4"	1/10
PFA360	6"	1/10

Fitting C.O. Adapter with Plug

Spg x FPT



- Solvent welds into fitting hub to provide access to piping
- Teflon thread tape is recommended for threaded joints

PART NO.	SIZE	CTN/MSTR
PFA615	1-1/2"	1/50
PFA620	2"	1/50
PFA630	3"	1/25
PFA640	4"	1/10

45° Street Elbow

Spg x H



- Used to change direction from a fitting hub to a pipe
- Sometimes called a "Street 1/8 bend"

PART NO.	SIZE	CTN/MSTR
PSL715S	1-1/2" short turn	1/100
PSL716S	1-1/2" long turn	1/100
PSL720	2"	1/50
PSL730	3"	1/20
PSL740	4"	1/10
PSL760	6"	1/3

60° Elbow

H x H



- Used to change direction in piping
- Sometimes called a "OK bend"

PART NO.	SIZE	CTN/MSTR
PFL915	1-1/2"	1/40
PFL930	3"	1/20

90° Vent Elbow

H x H



- Used to change direction in the "dry" portion of vent piping where water flow is not a consideration

PART NO.	SIZE	CTN/MSTR
PFL715	1-1/2"	1/20
PFL720	2"	1/30
PFL730	3"	1/10

90° Elbow

H x H



- Used to change direction in piping
- Sometimes called a "1/4 bend"

PART NO.	SIZE	CTN/MSTR
PFL814	1-1/4"	1/100
PFL815	1-1/2"	1/100
PFL820	2"	1/50
PFL830	3"	1/25
PFL840	4"	1/10
PFL860	6"	1/5
PFL821	2" x 1-1/2"	1/20
PFL834	4" x 3"	1/20

90° Elbow with Side Inlet

H x H x Spg/H



- Used to connect a branch line or vent at a change of direction in a larger vertical or horizontal pipe
- The inlet is constructed to accept a 2" fitting over its outside diameter or a 1-1/2" pipe into its inside diameter

PART NO.	SIZE	CTN/MSTR
PFL131	3" x 2" Spg or 1-1/2" Hub	1/20

90° Street Elbow

Spg x H



- Used to change direction in piping
- Sometimes called a "street 1/4 bend"

PART NO.	SIZE	CTN/MSTR
PSL916	1-1/2"	1/100
PSL926	2"	1/50
PSL936	3"	1/20
PSL946	4"	1/10

90° Long Sweep Elbow

H x H



- Used to change direction in piping
- Sometimes called a "long turn 1/4 bend"

PART NO.	SIZE	CTN/MSTR
PFL815L	1-1/2"	1/50
PFL820L	2"	1/25
PFL830L	3"	1/10
PFL840L	4"	1/5

90° Lowwheel Inlet Elbow

H x H x Spg/H or H x H x H



- Used to connect a branch line or vent at a change of direction in a larger vertical or horizontal pipe
- The inlet is constructed to accept a 2" fitting over its outside diameter or a 1-1/2" pipe into its inside diameter

PART NO.	SIZE	CTN/MSTR
PFL031	3" x 2" Spg or 1-1/2" Hub	1/25
PFL032	3" x 2" Hub	1/25

Fitting C.O. Adapter

Spg x FPT



- Solvent welds into fitting hub and adapts to male threaded plug
- This fitting is a component part of "Fitting Cleanout with Threaded Plug"

PART NO.	SIZE	CTN/MSTR
PFA614	1-1/2"	1/50
PFA619	2"	1/50
PFA629	3"	1/25
PFA639	4"	1/10
PFA659	6"	1/10

PVC DWV

Cap

Hub



- Used for permanently or temporarily capping pipe

PART NO.	SIZE	CTN/MSTR
PHC151	1-1/2"	1/10
PHC152	2"	1/5
PHC153	3"	1/10
PHC154	4"	1/5

22-1/2° Elbow

H x H



- Used to change direction in piping
- Sometimes called a "1/16 bend"

PART NO.	SIZE	CTN/MSTR
PFL515	1-1/2"	1/50
PFL520	2"	1/25
PFL530	3"	1/20
PFL540	4"	1/15
PFL560	6"	1/3

22-1/2° Street Elbow

H x Spg



- Used to change direction in piping
- Sometimes called a "Street 1/16 bend"

PART NO.	SIZE	CTN/MSTR
PSL815	1-1/2"	1/50
PSL820	2"	1/25
PSL830	3"	1/20
PSL840	4"	1/10

45° Elbow

H x H



- Used to change direction in piping
- Sometimes called a "1/8 bend"

PART NO.	SIZE	CTN/MSTR
PFL614	1-1/4"	1/100
PFL615	1-1/2"	1/100
PFL620	2"	1/50
PFL630	3"	1/20
PFL640	4"	1/10
PFL660	6"	1/3
PFL615S	1-1/2" short turn	1/100
PFL620S	2" short turn	1/100

Double 90° Elbow

H x H x H



- Ideal for "back to back" sink or lavatory installations

PART NO.	SIZE	CTN/MSTR
PDL716	1-1/2"	1/20
PDL736	3"	1/10
PDL722	2" x 1-1/2" x 1-1/2"	1/25

Wye

H x H x H



- Used when connecting a branch line into a horizontal drain pipe
- Also used in conjunction with a "twist-lok" plug to provide a cleanout in a drain pipe

PART NO.	SIZE	CTN/MSTR
PFY015	1-1/2"	1/50
PFY020	2"	1/25
PFY030	3"	1/25
PFY040	4"	1/5
PFY060	6"	1/4
PFY021	2" x 1-1/2"	1/25
PFY023	2" x 1-1/2" x 1-1/2"	1/25
PFY031	3" x 1-1/2"	1/15
PFY032	3" x 2"	1/25
PFY041	4" x 4" x 1-1/2"	1/10
PFY042	4" x 2"	1/10
PFY043	4" x 3"	1/10
PFY064	6" x 4"	1/5

**PVC
DWV**

Double Wye

H x H x H x H



- Used to bring two branch lines into a horizontal drain pipe

PART NO.	SIZE	CTN/MSTR
PDY415	1-1/2"	1/40
PDY420	2"	1/20
PDY430	3"	1/15
PDY440	4"	1/5
PDY442	4" x 4" x 2" x 2"	1/5
PDY443	4" x 4" x 3" x 3"	1/5

Double Fixture Tee

H x H x H x H



PART NO.	SIZE	CTN/MSTR
PDT621	2" x 1-1/2" x 1-1/2" x 1-1/2"	1/20

Vent Tee

H x H x H



- Used primarily in seepage bed piping grids in conjunction with perforated pipe
- Used where flow characteristics are not a primary consideration

PART NO.	SIZE	CTN/MSTR
PVT415	1-1/2"	1/10
PVT420	2"	1/10
PVT430	3"	1/10
PVT440	4"	1/10

Long Turn Tee Wye

H x H x H



- Used in some plumbing code areas to connect a branch line into a vertical drain pipe instead of a conventional tee fitting
- Also used to connect horizontal branch pipe approaching a horizontal drain pipe on the perpendicular

PART NO.	SIZE	CTN/MSTR
PFY515L	1-1/2"	1/20
PFY520L	2"	1/10
PFY530L	3"	1/10
PFY540L	4"	1/5
PFY521	2" x 1-1/2"	1/20
PFY531	3" x 1-1/2"	1/10
PFY532	3" x 2"	1/10
PFY542	4" x 2"	1/10
PFY543	4" x 3"	1/5

Cleanout Test Tee

H x H x FPT



- Used in conjunction with a threaded plug to provide a cleanout opening
- Teflon thread tape is recommended for threaded joints

PART NO.	SIZE	CTN/MSTR
PCT416	1-1/2"	1/20
PCT421	2"	1/20
PCT431	3"	1/10
PCT441	4"	1/10

Cleanout Test Tee with Cleanout Plug

H x H x FPT



- Used at the base of a vertical drain pipe to provide a cleanout opening flush with the finished wall

PART NO.	SIZE	CTN/MSTR
PCT315	1-1/2"	1/10
PCT320	2"	1/10
PCT330	3"	1/10
PCT340	4"	1/5

Sanitary Tee

H x H x H



- Used when connecting a branch line into a vertical drain pipe

PART NO.	SIZE	CTN/MSTR
PST114	1-1/4"	1/25
PST115	1-1/2"	1/100
PST120	2"	1/35
PST130	3"	1/30
PST140	4"	1/5
PST160	6"	1/6
PST121	2" x 1-1/2"	1/50
PST122	2" x 1-1/2" x 2"	1/25
PST123	2" x 1-1/2" x 1-1/2"	1/25
PST131	3" x 1-1/2"	1/20
PST132	3" x 2"	1/10
PST141	4" x 1-1/2"	1/10
PST142	4" x 2"	1/10
PST143	4" x 3"	1/10
PST164	6" x 4"	1/6

PVC DWV

Sanitary Tee Street

Spg x H x H



PART NO.	SIZE	CTN/MSTR
PSS140	4"	1/10

Sanitary Tee with Right Side Inlet

H x H x H x H



• Provides for the connection of 2" vent or branch waste piping to a vertical pipe

PART NO.	SIZE	CTN/MSTR
PST232	3" x 3" x 3" x 2"	1/10

Sanitary Tee with Left Side Inlet

H x H x H x H



• Provides for the connection of 2" vent or branch waste piping to a vertical pipe

PART NO.	SIZE	CTN/MSTR
PSL132	3" x 3" x 3" x 2"	1/10

Sanitary Tee with Right and Left Side Inlet

H x H x Spg/H x Spg/H



Sanitary Tee with Right and Left Side Inlet

- Provides for the connection of 1-1/2" or 2" vent or branch waste piping to a vertical pipe as well as receiving the discharge of a water closet
- The inlets are constructed to accept a 2" fitting hub over their outside diameter or a 1-1/2" pipe into their inside diameter

PART NO.	SIZE	CTN/MSTR
PSL031	3" x 3" x 3" x 1-1/2" / 2" x 1-1/2" / 2"	1/10

Sanitary Tee with Right and Left Side Inlet

- Provides for the connection of 2" vent or branch waste piping to a vertical pipe as well as receive the discharge of a water closet

PART NO.	SIZE	CTN/MSTR
PSL042	4" x 4" x 4" x 2" x 2"	1/5

Double Sanitary Tee

H x H x H x H



- Used to bring two branch lines into a vertical drain pipe

PART NO.	SIZE	CTN/MSTR
PDT515	1-1/2"	1/25
PDT520	2"	1/20
PDT530	3"	1/20
PDT540	4"	1/4
PDT521	2" x 2" x 1-1/2" x 1-1/2"	1/15
PDT531	3" x 3" x 1-1/2" x 1-1/2"	1/20
PDT532	3" x 3" x 2" x 2"	1/10
PDT542	4" x 4" x 2" x 2"	1/5
PDT543	4" x 4" x 3" x 3"	1/5

Two-Way Cleanout Tee

H x H x H



- Used with a vertical pipe stack, this fitting provides for above ground level access to piping

PART NO.	SIZE	CTN/MSTR
PTC633	3"	1/10
PTC644	4"	1/5

P-Trap LA Pattern with Union

SJ x H



- Used to prevent the passage of sewer gas from the plumbing system into house through the plumbing fixture drain, when local code doesn't permit the use of slip coupled traps

PART NO.	SIZE	CTN/MSTR
PPT715	1-1/2"	1/20

P-Trap with Union

H x H



- Used to prevent the passage of sewer gas from the plumbing system into house through the plumbing fixture drain

PART NO.	SIZE	CTN/MSTR
PPT315	1-1/2"	1/20
PPT320	2"	1/25

PVC DWV

P-Trap with Solvent Weld Joint

H x H



- Used to prevent the passage of sewer gas from the plumbing system into house through the plumbing fixture drain

PART NO.	SIZE	CTN/MSTR
PPT515	1-1/2"	1/25
PPT520	2"	1/20
PPT530	3"	1/10
PPT540	4"	1/4

P-Trap with Cleanout and Solvent Weld Joint

H x H



- Used to prevent the passage of sewer gas from the plumbing system into house through the plumbing fixture drain

PART NO.	SIZE	CTN/MSTR
PPT415	1-1/2"	1/10
PPT420	2"	1/10

P-Trap U-Bend

H x H



- Bottom part of trap furnished without cleanout

PART NO.	SIZE	CTN/MSTR
PPT015	1-1/2"	1/20
PPT020	2"	1/20
PPT030	3"	1/15
PPT040	4"	1/10

P-Trap Elbow

Spg x H Short Sweep



- Used to change direction in the "dry" portion of vent piping where water flow is not a consideration

PART NO.	SIZE	CTN/MSTR
PPT915S	1-1/2"	1/100
PPT920S	2"	1/20

Swivel Drum Trap

H x H



- PVC version of the old style bathtub "drum trap"
- Largely replaced today by the conventional 1-1/2" P-trap

PART NO.	SIZE	CTN/MSTR
PDT715	3" x 6" x 1-1/2"	1/15

Female Trap Adapter with Self Sealing Nut

H x SJT



- Utilized to adapt PVC pipe to tubular traps at wall or floor
- Utilizes special washer which seals to either 1-1/2" or 1-1/4" tubular products, reducing the number of SKU's needed in inventory
- Solvent welds over a 1-1/2" DWV pipe
- Sometimes referred to as a "marvel"

PART NO.	SIZE	CTN/MSTR
PTA215	1-1/2"	1/100
PTA221	1-1/2" x 1-1/2" or 1-1/4"	1/100

Male Trap Adapter less Washer and Nuts

Spg x MPT



- Adapts fitting hub to standard female pipe threads
- Teflon thread tape is recommended for threaded joints

PART NO.	SIZE	CTN/MSTR
PTA415	1-1/2" (less washer)	1/100
PTA420	2" (less washer)	1/100

Male Trap Adapter with Washer and Nuts

Spg x SJT



- Adapts PVC fitting hub to tubular traps in a wall or floor
- Utilizes special washer which seals to either 1-1/2" or 1-1/4" tubular products, reducing the number of SKU's needed in inventory
- Solvent welds into a 1-1/2" DWV fitting hub
- Sometimes called a "marvel"

PART NO.	SIZE	CTN/MSTR
PTA315	1-1/2" (with washer)	1/50
PTA311	1-1/2" x 1-1/2" or 1-1/4" (with washer)	1/75

Reducing Closet Bend

Spg x H



- Used to change direction in piping and size of pipe directly into fitting hub
- Usually a closet flange directly under a toilet
- Works well in tight space applications on second floors

PART NO.	SIZE	CTN/MSTR
PCB934	4" x 3"	1/20

PVC
DWV

Expansion Joint

H x H



- To provide for expansion in straight vertical pipe runs exceeding 35 feet in length

PART NO.	SIZE	CTN/MSTR
PEJ530	3"	1/10
PEJ540	4"	1/10

Cast Iron No Hub Adapter

Spg x H



- Adapts no hub elastomer coupling to DWV spigot
- Provides a proper method of adapting from no-hub cast iron pipe utilizing the standard no-hub clamp ring

PART NO.	SIZE	CTN/MSTR
PNH120	2"	1/100
PNH130	3"	1/20
PNH140	4"	1/10

Cast Iron Hub Adapter

Spg x H



- Adapts cast iron hub to DWV Spigot
- Can be joined to cast iron with Genova plastic lead or hot molten lead

PART NO.	SIZE	CTN/MSTR
PHA520	2"	1/25
PHA521	2" x 1-1/2"	1/20
PHA530	3"	1/20
PHA540	4"	1/10
PHA543	4" x 3"	1/20

Cast Iron Spigot Adapter

H x H



- Adapts cast iron spigot to DWV spigot
- Adapts Sch. 40 pipe to 4" cast iron spigot

PART NO.	SIZE	CTN/MSTR
PSA740	4"	1/10

Adapter Coupling

Sewer H x DWV H



- Adapts sewer and drain spigot to DWV spigot

PART NO.	SIZE	CTN/MSTR
PAC543	4" x 3"	1/20

Adapter Bushing

DWV Spg x Sewer H



- Adapts DWV hub to sewer and drain spigot

PART NO.	SIZE	CTN/MSTR
PAB75340	4"	1/25

Adapter Bushing

Sewer Spg x DWV H



- Adapts sewer and drain hub to DWV spigot

PART NO.	SIZE	CTN/MSTR
PAB243	4" x 3"	1/20

**PVC
DWV**

BLACK & GALVANIZED MALLEABLES & PIPE NIPPLES

Black and Galvanized Malleable Fittings.....	351-355
Black and Galvanized Pipe Nipples.....	356-357
Black and Galvanized Readycut Pipe.....	358
Black and Galvanized Merchant Couplings.....	359

BG

*Published March 2017. List prices can be found in list price book and on our website.

HEX Bushing

M x F, Concentric



- CSA
- UL listed
- FM
- NSF 61-4 and AB1953
- Meets ASTM A197, ASME B16.3, and ASTM A153



BLACK PART NO.	GALV. PART NO.	SIZE	CTN/MSTR
B144-0007	G144-0007	1/4" x 1/8"	120/1,440
B144-0032	G144-0032	3/8" x 1/4"	75/900
B144-0033	G144-0033	3/8" x 1/8"	75/900
B144-0058	G144-0058	1/2" x 3/8"	100/1,200
B144-0059	G144-0059	1/2" x 1/4"	100/1,200
B144-0060	G144-0060	1/2" x 1/8"	100/1,200
B144-0107	G144-0107	3/4" x 1/2"	50/600
B144-0108	G144-0108	3/4" x 3/8"	50/600
B144-0109	G144-0109	3/4" x 1/4"	50/600
B144-0110	G144-0110	3/4" x 1/8"	50/600
B144-0159	G144-0159	1" x 3/4"	50/400
B144-0160	G144-0160	1" x 1/2"	50/400
B144-0161	G144-0161	1" x 3/8"	50/400
B144-0162	G144-0162	1" x 1/4"	50/400
B144-0222	G144-0222	1-1/4" x 1"	30/240
B144-0223	G144-0223	1-1/4" x 3/4"	30/240
B144-0224	G144-0224	1-1/4" x 1/2"	30/240
B144-0225	G144-0225	1-1/4" x 3/8"	30/240
B144-0226	G144-0226	1-1/4" x 1/4"	30/240
B144-0303	G144-0303	1-1/2" x 1-1/4"	25/150
B144-0304	G144-0304	1-1/2" x 1"	25/150
B144-0305	G144-0305	1-1/2" x 3/4"	25/150
B144-0306	G144-0306	1-1/2" x 1/2"	25/150
B144-0307	G144-0307	1-1/2" x 3/8"	25/150
B144-0308	G144-0308	1-1/2" x 1/4"	25/150
B144-0398	G144-0398	2" x 1-1/2"	20/120
B144-0399	G144-0399	2" x 1-1/4"	20/120
B144-0400	G144-0400	2" x 1"	20/120
B144-0401	G144-0401	2" x 3/4"	20/120
B144-0402	G144-0402	2" x 1/2"	20/120
B144-0403	—	2" x 3/8"	20/120
B144-0531	G144-0531	2-1/2" x 2"	15/60
B144-0532	G144-0532	2-1/2" x 1-1/2"	15/60
B144-0533	G144-0533	2-1/2" x 1-1/4"	15/60
B144-0534	G144-0534	2-1/2" x 1"	15/60
B144-0535	G144-0535	2-1/2" x 3/4"	15/60
B144-0536	—	2-1/2" x 1/2"	15/60
B144-0662	G144-0662	3" x 2-1/2"	12/48
B144-0663	G144-0663	3" x 2"	12/48
B144-0664	G144-0664	3" x 1-1/2"	12/48
B144-0665	G144-0665	3" x 1-1/4"	12/48
B144-0666	G144-0666	3" x 1"	12/48
B144-0667	—	3" x 3/4"	12/48
B144-0790	G144-0790	3-1/2" x 3"	8/32
B144-0870	G144-0870	4" x 3"	5/20
B144-0871	G144-0871	4" x 2-1/2"	5/20
B144-0872	G144-0872	4" x 2"	5/20
B144-0873	G144-0873	4" x 1-1/2"	5/20
B144-0875	—	4" x 1"	5/20
B144-1109	G144-1109	6" x 4"	4/8
B144-1111	—	6" x 3"	4/8

Cap



- CSA
- UL listed
- FM
- NSF 61-4 and AB1953
- Meets ASTM A197, ASME B16.3, and ASTM A153



BLACK PART NO.	GALV. PART NO.	SIZE	CTN/MSTR
B155-0001	G155-0001	1/8"	120/1,440
B155-0002	G155-0002	1/4"	80/960
B155-0025	G155-0025	3/8"	60/720
B155-0050	G155-0050	1/2"	75/600
B155-0100	G155-0100	3/4"	40/320
B155-0150	G155-0150	1"	35/200
B155-0215	G155-0215	1-1/4"	25/160
B155-0295	G155-0295	1-1/2"	25/108
B155-0390	G155-0390	2"	18/72
B155-0520	G155-0520	2-1/2"	14/56
B155-0650	G155-0650	3"	12/36
B155-0860	G155-0860	4"	7/21
B155-0975	G155-0975	5"	8/16
B155-1100	G155-1100	6"	4/8

Extension Piece

M x F



- CSA
- UL listed
- FM
- NSF 61-4 and AB1953
- Meets ASTM A197, ASME B16.3, and ASTM A153



BLACK PART NO.	GALV. PART NO.	SIZE	CTN/MSTR
B335-0050	G335-0050	1/2"	75/600
B335-0100	G335-0100	3/4"	40/320
B335-0150	G335-0150	1"	30/180
B335-0215	G335-0215	1-1/4"	30/120
B335-0390	—	2"	15/60

Coupling, Banded

F x F



- CSA
- UL listed
- FM
- NSF 61-4 and AB1953
- Meets ASTM A197, ASME B16.3, and ASTM A153



BLACK PART NO.	GALV. PART NO.	SIZE	CTN/MSTR
B165-0001	G165-0001	1/8"	70/840
B165-0002	G165-0002	1/4"	40/480
B165-0025	G165-0025	3/8"	50/600
B165-0050	G165-0050	1/2"	60/480
B165-0100	G165-0100	3/4"	50/300
B165-0150	G165-0150	1"	25/150
B165-0215	G165-0215	1-1/4"	32/128
B165-0295	G165-0295	1-1/2"	18/72
B165-0390	G165-0390	2"	12/48
B165-0520	G165-0520	2-1/2"	4/32
B165-0650	G165-0650	3"	12/24
B165-0860	G165-0860	4"	3/12
B165-1100	G165-1100	6"	3/6

BG

Reducing Coupling, Banded

F x F, Concentric



- CSA
- UL listed
- FM
- NSF 61-4 and AB1953
- Meets ASTM A197, ASME B16.3, and ASTM A153



BLACK PART NO.	GALV. PART NO.	SIZE	CTN/MSTR
B165-0007	G165-0007	1/4" x 1/8"	50/600
B165-0032	G165-0032	3/8" x 1/4"	30/360
B165-0033	G165-0033	3/8" x 1/8"	35/420
B165-0058	G165-0058	1/2" x 3/8"	40/480
B165-0059	G165-0059	1/2" x 1/4"	50/600
B165-0060	G165-0060	1/2" x 1/8"	50/600
B165-0107	G165-0107	3/4" x 1/2"	60/360
B165-0108	G165-0108	3/4" x 3/8"	30/360
B165-0109	G165-0109	3/4" x 1/4"	30/360
B165-0110	—	3/4" x 1/8"	35/420
B165-0159	G165-0159	1" x 3/4"	25/200
B165-0160	G165-0160	1" x 1/2"	40/240
B165-0161	G165-0161	1" x 3/8"	40/240
B165-0162	G165-0162	1" x 1/4"	45/270
B165-0222	G165-0222	1-1/4" x 1"	20/120
B165-0223	G165-0223	1-1/4" x 3/4"	25/150
B165-0224	G165-0224	1-1/4" x 1/2"	25/150
B165-0303	G165-0303	1-1/2" x 1-1/4"	24/96
B165-0304	G165-0304	1-1/2" x 1"	25/100
B165-0305	G165-0305	1-1/2" x 3/4"	30/120
B165-0306	G165-0306	1-1/2" x 1/2"	20/120
B165-0307	G165-0307	1-1/2" x 3/8"	30/120
B165-0398	G165-0398	2" x 1-1/2"	12/72
B165-0399	G165-0399	2" x 1-1/4"	14/72
B165-0400	G165-0400	2" x 1"	14/84
B165-0401	G165-0401	2" x 3/4"	14/84
B165-0402	G165-0402	2" x 1/2"	14/84
B165-0531	G165-0531	2-1/2" x 2"	10/40
B165-0532	G165-0532	2-1/2" x 1-1/2"	10/40
B165-0533	G165-0533	2-1/2" x 1-1/4"	10/40
B165-0534	G165-0534	2-1/2" x 1"	10/40
B165-0535	—	2-1/2" x 3/4"	10/40
B165-0662	G165-0662	3" x 2-1/2"	12/24
B165-0663	G165-0663	3" x 2"	8/32
B165-0664	G165-0664	3" x 1-1/2"	8/32
B165-0665	G165-0665	3" x 1-1/4"	8/32
B165-0666	G165-0666	3" x 1"	8/32
B165-0870	G165-0870	4" x 3"	6/12
B165-0871	G165-0871	4" x 2-1/2"	6/18
B165-0872	G165-0872	4" x 2"	6/12
B165-0873	—	4" x 1-1/2"	6/18
—	G165-1109	6" x 4"	4/8

90° Reducing Elbow, Banded

F x F



- CSA
- UL listed
- FM
- NSF 61-4 and AB1953
- Meets ASTM A197, ASME B16.3, and ASTM A153



BLACK PART NO.	GALV. PART NO.	SIZE	CTN/MSTR
B235-0007	—	1/4" x 1/8"	1/480
B235-0032	—	3/8" x 1/4"	60/720
B235-0058	G235-0058	1/2" x 3/8"	50/400
B235-0059	G235-0059	1/2" x 1/4"	40/480
B235-0060	—	1/2" x 1/8"	40/480
B235-0107	G235-0107	3/4" x 1/2"	40/240
B235-0108	G235-0108	3/4" x 3/8"	50/300
B235-0159	G235-0159	1" x 3/4"	25/150
B235-0160	G235-0160	1" x 1/2"	30/180
B235-0222	G235-0222	1-1/4" x 1"	20/80
B235-0223	G235-0223	1-1/4" x 3/4"	30/120
B235-0224	G235-0224	1-1/4" x 1/2"	35/140
B235-0303	G235-0303	1-1/2" x 1-1/4"	15/60
B235-0304	G235-0304	1-1/2" x 1"	20/80
B235-0305	G235-0305	1-1/2" x 3/4"	15/90
B235-0306	G235-0306	1-1/2" x 1/2"	25/100
B235-0398	G235-0398	2" x 1-1/2"	10/40
B235-0399	G235-0399	2" x 1-1/4"	10/40
B235-0400	G235-0400	2" x 1"	14/56
B235-0401	G235-0401	2" x 3/4"	15/60
B235-0402	—	2" x 1/2"	15/60
B235-0531	—	2-1/2" x 2"	12/24
B235-0532	G235-0532	2-1/2" x 1-1/2"	6/24
B235-0533	G235-0533	2-1/2" x 1-1/4"	6/40
B235-0662	G235-0662	3" x 2-1/2"	4/16
B235-0663	G235-0663	3" x 2"	6/18

90° Elbow, Banded

F x F



- CSA
- UL listed
- FM
- NSF 61-4 and AB1953
- Meets ASTM A197, ASME B16.3, and ASTM A153



BLACK PART NO.	GALV. PART NO.	SIZE	CTN/MSTR
B235-0001	G235-0001	1/8"	50/600
B235-0002	G235-0002	1/4"	35/420
B235-0025	G235-0025	3/8"	45/540
B235-0050	G235-0050	1/2"	50/400
B235-0100	G235-0100	3/4"	35/210
B235-0150	G235-0150	1"	20/120
B235-0215	G235-0215	1-1/4"	20/80
B235-0295	G235-0295	1-1/2"	20/60
B235-0390	G235-0390	2"	8/32
B235-0520	G235-0520	2-1/2"	8/18
B235-0650	G235-0650	3"	7/14
B235-0860	G235-0860	4"	2/6
B235-0975	—	5"	2/4
B235-1100	G235-1100	6"	1/2

BG

90° Street Elbow, Banded

M x F



- CSA
- UL listed
- FM
- NSF 61-4 and AB1953
- Meets ASTM A197, ASME B16.3, and ASTM A153



BLACK PART NO.	GALV. PART NO.	SIZE	CTN/MSTR
B254-0001	G254-0001	1/8"	60/720
B254-0002	G254-0002	1/4"	35/420
B254-0025	G254-0025	3/8"	40/480
B254-0050	G254-0050	1/2"	60/360
B254-0100	G254-0100	3/4"	35/210
B254-0150	G254-0150	1"	30/120
B254-0215	G254-0215	1-1/4"	25/75
B254-0295	G254-0295	1-1/2"	18/54
B254-0390	G254-0390	2"	10/30
B254-0520	G254-0520	2-1/2"	9/18
B254-0650	G254-0650	3"	1/14
B254-0860	G254-0860	4"	1/6

45° Elbow, Banded

F x F



- CSA
- UL listed
- FM
- NSF 61-4 and AB1953
- Meets ASTM A197, ASME B16.3, and ASTM A153



BLACK PART NO.	GALV. PART NO.	SIZE	CTN/MSTR
B290-0001	G290-0001	1/8"	50/600
B290-0002	G290-0002	1/4"	30/360
B290-0025	G290-0025	3/8"	50/600
B290-0050	G290-0050	1/2"	50/400
B290-0100	G290-0100	3/4"	40/240
B290-0150	G290-0150	1"	20/120
B290-0215	G290-0215	1-1/4"	20/80
B290-0295	G290-0295	1-1/2"	15/60
B290-0390	G290-0390	2"	12/36
B290-0520	G290-0520	2-1/2"	1/27
B290-0650	G290-0650	3"	1/20
B290-0860	G290-0860	4"	1/6

45° Street Elbow, Banded

M x F



- CSA
- UL listed
- FM
- NSF 61-4 and AB1953
- Meets ASTM A197, ASME B16.3, and ASTM A153



BLACK PART NO.	GALV. PART NO.	SIZE	CTN/MSTR
B295-0001	—	1/8"	70/840
B295-0002	G295-0002	1/4"	40/480
B295-0025	—	3/8"	50/600
B295-0050	G295-0050	1/2"	75/450
B295-0100	G295-0100	3/4"	40/240
B295-0150	G295-0150	1"	25/150
B295-0215	G295-0215	1-1/4"	20/80
B295-0295	G295-0295	1-1/2"	20/60
B295-0390	G295-0390	2"	12/36
B295-0520	—	2-1/2"	1/24
B295-0650	G295-0650	3"	1/18
B295-0860	—	4"	1/7

Cross, Banded

F x F x F x F



- CSA
- UL listed
- FM
- NSF 61-4 and AB1953
- Meets ASTM A197, ASME B16.3, and ASTM A153



BLACK PART NO.	GALV. PART NO.	SIZE	CTN/MSTR
B195-0002	G195-0002	1/4"	80/480
B195-0025	G195-0025	3/8"	50/300
B195-0050	G195-0050	1/2"	45/180
B195-0100	G195-0100	3/4"	30/120
B195-0150	G195-0150	1"	20/60
B195-0215	G195-0215	1-1/4"	20/40
B195-0295	G195-0295	1-1/2"	18/36
—	G195-0390	2"	10/20

Floor Flange



- CSA
- UL listed
- FM
- NSF 61-4 and AB1953
- Meets ASTM A197, ASME B16.3, and ASTM A153



BLACK PART NO.	GALV. PART NO.	SIZE	CTN/MSTR
B355-0025	G355-0025	3/8"	25/150
B355-0050	G355-0050	1/2"	25/100
B355-0100	G355-0100	3/4"	20/80
B355-0150	G355-0150	1"	20/60
B355-0215	G355-0215	1-1/4"	15/60
B355-0295	G355-0295	1-1/2"	12/48
B355-0390	G355-0390	2"	8/32

Locknut/Backnut



- CSA
- UL listed
- FM
- NSF 61-4 and AB1953
- Meets ASTM A197, ASME B16.3, and ASTM A153



BLACK PART NO.	GALV. PART NO.	SIZE	CTN/MSTR
—	G375-0002	1/4"	125/1500
—	G375-0050	1/2"	100/1200
—	G375-0150	1"	60/480
—	G375-0215	1-1/4"	60/360
—	G375-0295	1-1/2"	45/270
—	G375-0390	2"	25/150

BG

Street Tee, Banded

F x M x F



- CSA
- UL listed
- FM
- NSF 61-4 and AB1953
- Meets ASTM A197, ASME B16.3, and ASTM A153



BLACK PART NO.	GALV. PART NO.	SIZE	CTN/MSTR
B486-0050	—	1/2"	40/240
B486-0100	G486-0100	3/4"	25/150
B486-0150	G486-0150	1"	20/80

Tee, Banded

F x F x F



- CSA
- UL listed
- FM
- NSF 61-4 and AB1953
- Meets ASTM A197, ASME B16.3, and ASTM A153



BLACK PART NO.	GALV. PART NO.	SIZE	CTN/MSTR
B460-0001	G460-0001	1/8"	80/960
B460-0002	G460-0002	1/4"	50/600
B460-0025	G460-0025	3/8"	45/360
B460-0050	G460-0050	1/2"	40/240
B460-0100	G460-0100	3/4"	35/140
B460-0150	G460-0150	1"	20/80
B460-0215	G460-0215	1-1/4"	14/56
B460-0295	G460-0295	1-1/2"	15/45
B460-0390	G460-0390	2"	10/30
B460-0520	G460-0520	2-1/2"	8/16
B460-0650	G460-0650	3"	6/12
B460-0860	G460-0860	4"	2/6
B460-1100	—	6"	2/2

Reducing Tee, Banded

F x F x F



- CSA
- UL listed
- FM
- NSF 61-4 and AB1953
- Meets ASTM A197, ASME B16.3, and ASTM A153



BLACK PART NO.	GALV. PART NO.	SIZE	CTN/MSTR
B460-0032	—	3/8" x 1/4"	60/300
B460-0056	—	1/2" x 1"	40/160
B460-0057	G460-0057	1/2" x 3/4"	30/180
B460-0058	G460-0058	1/2" x 3/8"	45/270
B460-0059	G460-0059	1/2" x 1/4"	50/300
B460-0106	G460-0106	3/4" x 1"	20/120
B460-0107	G460-0107	3/4" x 1/2"	45/180
B460-0108	G460-0108	3/4" x 3/8"	45/180
B460-0109	G460-0109	3/4" x 1/4"	50/200
B460-0116	G460-0116	3/4" x 1/2" x 1"	35/140
B460-0117	G460-0117	3/4" x 1/2" x 3/4"	40/160
B460-0118	G460-0118	3/4" x 1/2" x 1/2"	30/180
—	G460-0157	1" x 1-1/2"	15/60
B460-0158	—	1" x 1-1/4"	15/60
B460-0159	G460-0159	1" x 3/4"	25/100
B460-0160	G460-0160	1" x 1/2"	30/120
B460-0162	G460-0162	1" x 1/4"	25/150
B460-0169	G460-0169	1" x 3/4" x 1"	15/90
B460-0170	G460-0170	1" x 3/4" x 3/4"	25/100
B460-0171	G460-0171	1" x 3/4" x 1/2"	25/120
B460-0180	G460-0180	1" x 1/2" x 1"	15/90
B460-0181	G460-0181	1" x 1/2" x 3/4"	30/120
B460-0182	G460-0182	1" x 1/2" x 1/2"	20/120
—	G460-0215	1-1/4" x 2"	14/56
B460-0221	G460-0221	1-1/4" x 1-1/2"	14/56
B460-0222	G460-0222	1-1/4" x 1"	16/64
B460-0223	G460-0223	1-1/4" x 3/4"	18/72
B460-0224	G460-0224	1-1/4" x 1/2"	20/80
B460-0234	G460-0234	1-1/4" x 1" x 1-1/4"	15/60
B460-0235	G460-0235	1-1/4" x 1" x 1"	18/72
B460-0236	G460-0236	1-1/4" x 1" x 3/4"	18/72
B460-0237	G460-0237	1-1/4" x 1" x 1/2"	18/72

Reducing Tee, Banded (cont.)

BLACK PART NO.	GALV. PART NO.	SIZE	CTN/MSTR
B460-0245	G460-0245	1-1/4" x 3/4" x 1-1/4"	15/60
B460-0246	G460-0246	1-1/4" x 3/4" x 1"	20/80
B460-0247	G460-0247	1-1/4" x 3/4" x 3/4"	20/80
B460-0248	—	1-1/4" x 3/4" x 1/2"	25/100
B460-0256	—	1-1/4" x 1/2" x 1-1/4"	15/60
B460-0257	—	1-1/4" x 1/2" x 1"	20/80
B460-0258	G460-0258	1-1/4" x 1/2" x 3/4"	25/50
B460-0259	—	1-1/4" x 1/2" x 1/2"	25/50
B460-0302	—	1-1/2" x 2"	15/45
B460-0303	G460-0303	1-1/2" x 1-1/4"	15/45
B460-0304	G460-0304	1-1/2" x 1"	13/52
B460-0305	G460-0305	1-1/2" x 3/4"	10/60
B460-0306	G460-0306	1-1/2" x 1/2"	18/72
B460-0315	G460-0315	1-1/2" x 1-1/4" x 1-1/2"	10/40
B460-0316	G460-0316	1-1/2" x 1-1/4" x 1-1/4"	12/48
B460-0317	G460-0317	1-1/2" x 1-1/4" x 1"	14/56
B460-0318	G460-0318	1-1/2" x 1-1/4" x 3/4"	16/64
B460-0319	G460-0319	1-1/2" x 1-1/4" x 1/2"	16/64
B460-0328	G460-0328	1-1/2" x 1" x 1-1/2"	14/56
B460-0329	—	1-1/2" x 1" x 1-1/4"	14/56
B460-0330	G460-0330	1-1/2" x 1" x 1"	15/60
B460-0331	—	1-1/2" x 1" x 3/4"	15/60
B460-0339	—	1-1/2" x 3/4" x 1-1/2"	12/48
B460-0340	G460-0340	1-1/2" x 3/4" x 1-1/4"	15/60
B460-0342	—	1-1/2" x 3/4" x 3/4"	15/60
B460-0350	G460-0350	1-1/2" x 1/2" x 1-1/2"	12/48
B460-0398	G460-0398	2" x 1-1/2"	16/32
B460-0399	G460-0399	2" x 1-1/4"	8/32
B460-0400	G460-0400	2" x 1"	12/36
B460-0401	G460-0401	2" x 3/4"	10/40
B460-0402	G460-0402	2" x 1/2"	10/40
B460-0413	—	2" x 1-1/2" x 2"	10/30
B460-0414	G460-0414	2" x 1-1/2" x 1-1/2"	8/32
B460-0415	G460-0415	2" x 1-1/2" x 1-1/4"	8/32
B460-0416	G460-0416	2" x 1-1/2" x 1"	10/40
B460-0417	—	2" x 1-1/2" x 3/4"	10/40
B460-0429	G460-0429	2" x 1-1/4" x 2"	13/26
B460-0430	G460-0430	2" x 1-1/4" x 1-1/2"	8/32
B460-0431	G460-0431	2" x 1-1/4" x 1-1/4"	12/36
B460-0444	G460-0444	2" x 1" x 2"	8/32
B460-0447	G460-0447	2" x 1" x 1"	12/48
B460-0457	—	2" x 3/4" x 2"	8/32
B460-0470	G460-0470	2" x 1/2" x 2"	8/32
B460-0531	G460-0531	2-1/2" x 2"	4/16
B460-0532	G460-0532	2-1/2" x 1-1/2"	5/15
B460-0533	—	2-1/2" x 1-1/4"	10/20
B460-0534	G460-0534	2-1/2" x 1"	12/24
B460-0535	—	2-1/2" x 3/4"	12/24
B460-0536	G460-0536	2-1/2" x 1/2"	12/24
B460-0662	G460-0662	3" x 2-1/2"	6/12
B460-0663	G460-0663	3" x 2"	4/12
B460-0664	—	3" x 1-1/2"	4/12
B460-0665	G460-0665	3" x 1-1/4"	4/12
B460-0666	G460-0666	3" x 1"	5/15
B460-0667	—	3" x 3/4"	6/18
B460-0668	—	3" x 1/2"	6/18
B460-0870	G460-0870	4" x 3"	2/6
B460-0871	—	4" x 2-1/2"	2/6
B460-0872	G460-0872	4" x 2"	2/8
B460-0873	—	4" x 1-1/2"	2/8

Square Head Plug

M



- Cored
- CSA
- UL listed
- FM
- NSF 61-4 and AB1953
- Meets ASTM A197, ASME B16.3, and ASTM A153



BLACK PART NO.	GALV. PART NO.	SIZE	CTN/MSTR
B396-0001	G396-0001	1/8"	300/3600
B396-0002	G396-0002	1/4"	150/1800
B396-0025	G396-0025	3/8"	100/1200
B396-0050	G396-0050	1/2"	50/600
B396-0100	G396-0100	3/4"	30/360
B396-0150	G396-0150	1"	20/240
B396-0215	G396-0215	1-1/4"	40/240
B396-0295	G396-0295	1-1/2"	30/180
B396-0390	G396-0390	2"	20/120
B396-0520	G396-0520	2-1/2"	8/64
B396-0650	G396-0650	3"	8/48
B396-0860	G396-0860	4"	8/16
B396-1100	—	6"	5/10

Union



- Brass to iron seat
- CSA
- UL listed
- FM
- NSF 61-4 and AB1953
- Meets ASTM A197, ASME B16.3, and ASTM A153



BLACK PART NO.	GALV. PART NO.	SIZE	CTN/MSTR
B657-0001	G657-0001	1/8"	30/360
B657-0002	G657-0002	1/4"	20/240
B657-0025	G657-0025	3/8"	20/240
B657-0050	G657-0050	1/2"	50/200
B657-0100	G657-0100	3/4"	35/140
B657-0150	G657-0150	1"	20/80
B657-0215	G657-0215	1-1/4"	15/60
B657-0295	G657-0295	1-1/2"	10/40
B657-0390	G657-0390	2"	6/24
B657-0520	G657-0520	2-1/2"	4/16
B657-0650	G657-0650	3"	7/14
B657-0860	G657-0860	4"	7/7

BG

Pipe Nipples



BLACK PART NO.	GALV. PART NO.	SIZE	CTN/MSTR
30100	50100	1/8" x Close	25/400
30110	50110	1/8" x 10"	25/200
—	50111	1/8" x 11"	25/200
30112	50112	1/8" x 12"	25/200
30115	50115	1/8" x 1-1/2"	25/400
30120	50120	1/8" x 2"	25/400
30125	50125	1/8" x 2-1/2"	25/400
30130	50130	1/8" x 3"	25/400
30135	50135	1/8" x 3-1/2"	25/400
30140	50140	1/8" x 4"	25/400
30145	50145	1/8" x 4-1/2"	25/400
30150	50150	1/8" x 5"	25/400
30155	50155	1/8" x 5-1/2"	25/400
30160	50160	1/8" x 6"	25/400
30170	50170	1/8" x 7"	25/200
30180	50180	1/8" x 8"	25/200
—	50190	1/8" x 9"	25/200
30200	50200	1/4" x Close	25/400
30210	50210	1/4" x 10"	25/200
30211	50211	1/4" x 11"	25/200
30212	50212	1/4" x 12"	25/200
30215	50215	1/4" x 1-1/2"	25/400
30220	50220	1/4" x 2"	25/400
30225	50225	1/4" x 2-1/2"	25/400
30230	50230	1/4" x 3"	25/400
30235	50235	1/4" x 3-1/2"	25/400
30240	50240	1/4" x 4"	25/400
30245	50245	1/4" x 4-1/2"	25/400
30250	50250	1/4" x 5"	25/400
30255	50255	1/4" x 5-1/2"	25/400
30260	50260	1/4" x 6"	25/400
30270	50270	1/4" x 7"	25/200
30280	50280	1/4" x 8"	25/200
30290	50290	1/4" x 9"	25/200
30300	50300	3/8" x Close	25/400
30310	50310	3/8" x 10"	25/100
30311	—	3/8" x 11"	25/100
30312	50312	3/8" x 12"	25/100
30315	50315	3/8" x 1-1/2"	25/400
30320	50320	3/8" x 2"	25/400
30325	50325	3/8" x 2-1/2"	25/400
30330	50330	3/8" x 3"	25/400
30335	50335	3/8" x 3-1/2"	25/400
30340	50340	3/8" x 4"	25/400
30345	50345	3/8" x 4-1/2"	25/400
30350	50350	3/8" x 5"	25/300
30355	50355	3/8" x 5-1/2"	25/300
30360	50360	3/8" x 6"	25/300
30370	50370	3/8" x 7"	25/150
30380	50380	3/8" x 8"	25/150
30500	50500	1/2" x Close	25/400
30510	50510	1/2" x 10"	25/100
30511	50511	1/2" x 11"	25/100
30512	50512	1/2" x 12"	25/100
30515	50515	1/2" x 1-1/2"	25/400
30520	50520	1/2" x 2"	25/400
30525	50525	1/2" x 2-1/2"	25/300
30530	50530	1/2" x 3"	25/300
30535	50535	1/2" x 3-1/2"	25/300
30540	50540	1/2" x 4"	25/200
30545	50545	1/2" x 4-1/2"	25/200
30550	50550	1/2" x 5"	25/200
30555	50555	1/2" x 5-1/2"	25/200
30560	50560	1/2" x 6"	25/200
30570	50570	1/2" x 7"	25/100
30575	—	1/2" x 7-1/2"	25/100

Pipe Nipples (cont.)

BLACK PART NO.	GALV. PART NO.	SIZE	CTN/MSTR
30580	50580	1/2" x 8"	25/100
30590	50590	1/2" x 9"	25/100
30700	50700	3/4" x Close	25/400
30710	50710	3/4" x 10"	25/50
30711	50711	3/4" x 11"	25/50
30712	50712	3/4" x 12"	25/50
30715	50715	3/4" x 1-1/2"	25/400
30720	50720	3/4" x 2"	25/300
30725	50725	3/4" x 2-1/2"	25/300
30730	50730	3/4" x 3"	25/200
30735	50735	3/4" x 3-1/2"	25/200
30740	50740	3/4" x 4"	25/150
30745	50745	3/4" x 4-1/2"	25/150
30750	50750	3/4" x 5"	25/100
30755	50755	3/4" x 5-1/2"	25/100
30760	50760	3/4" x 6"	25/100
30765	—	3/4" x 6-1/2"	25/75
30770	50770	3/4" x 7"	25/75
30775	50775	3/4" x 7-1/2"	25/75
30780	50780	3/4" x 8"	25/75
30790	50790	3/4" x 9"	25/50
31000	51000	1" x Close	25/200
31010	51010	1" x 10"	25/50
31011	51011	1" x 11"	25/50
31012	51012	1" x 12"	25/50
31014	51014	1" x 14"	5/25
31020	51020	1" x 2"	25/200
31025	51025	1" x 2-1/2"	25/150
31030	51030	1" x 3"	25/150
31035	51035	1" x 3-1/2"	25/100
31040	51040	1" x 4"	25/100
31045	51045	1" x 4-1/2"	25/100
31050	51050	1" x 5"	25/75
31055	51055	1" x 5-1/2"	25/75
31060	51060	1" x 6"	25/50
31065	—	1" x 6-1/2"	25/50
31070	51070	1" x 7"	25/50
31075	—	1" x 7-1/2"	25/50
31080	51080	1" x 8"	25/50
31090	51090	1" x 9"	25/50
31200	51200	1-1/4" x Close	25/100
31210	51210	1-1/4" x 10"	20/40
31211	51211	1-1/4" x 11"	20/40
31212	51212	1-1/4" x 12"	10/30
31213	—	1-1/4" x 13"	3/30
31214	—	1-1/4" x 14"	3/30
31220	51220	1-1/4" x 2"	25/100
31225	51225	1-1/4" x 2-1/2"	25/100
31230	51230	1-1/4" x 3"	25/100
31235	51235	1-1/4" x 3-1/2"	25/50
31240	51240	1-1/4" x 4"	25/50
31245	51245	1-1/4" x 4-1/2"	25/50
31250	51250	1-1/4" x 5"	25/50
31255	51255	1-1/4" x 5-1/2"	25/50
31260	51260	1-1/4" x 6"	25/50
31270	51270	1-1/4" x 7"	25/50
31280	51280	1-1/4" x 8"	25/50
31285	—	1-1/4" x 8-1/2"	25/30
31290	51290	1-1/4" x 9"	25/50
31500	51500	1-1/2" x Close	25/100
31510	51510	1-1/2" x 10"	15/30
31511	51511	1-1/2" x 11"	15/30
31512	51512	1-1/2" x 12"	15/30
31514	—	1-1/2" x 14"	3/6
31520	51520	1-1/2" x 2"	25/100
31525	51525	1-1/2" x 2-1/2"	25/50
31530	51530	1-1/2" x 3"	25/50
31535	51535	1-1/2" x 3-1/2"	25/50
31540	51540	1-1/2" x 4"	25/50
31545	51545	1-1/2" x 4-1/2"	25/50
31550	51550	1-1/2" x 5"	25/50
31555	51555	1-1/2" x 5-1/2"	25/50
31560	51560	1-1/2" x 6"	25/50

BG

Pipe Nipples (cont.)

BLACK PART NO.	GALV. PART NO.	SIZE	CTN/MSTR
31570	51570	1-1/2" x 7"	20/40
31580	51580	1-1/2" x 8"	20/40
31590	51590	1-1/2" x 9"	10/20
32000	52000	2" x Close	25/50
32010	52010	2" x 10"	15/30
32011	52011	2" x 11"	15/30
32012	52012	2" x 12"	15/30
32013	—	2" x 13"	3/6
32025	52025	2" x 2-1/2"	25/50
32030	52030	2" x 3"	25/50
32035	52035	2" x 3-1/2"	25/50
32040	52040	2" x 4"	25/50
32045	52045	2" x 4-1/2"	25/50
32050	52050	2" x 5"	25/50
32055	52055	2" x 5-1/2"	25/50
32060	52060	2" x 6"	25/50
32065	—	2" x 6-1/2"	20/20
32070	52070	2" x 7"	20/20
32075	—	2" x 7-1/2"	20/20
32080	52080	2" x 8"	20/20
32090	52090	2" x 9"	20/20
32500	52500	2-1/2" x Close	20/40
32510	52510	2-1/2" x 10"	10/10
32511	52511	2-1/2" x 11"	10/10
32512	52512	2-1/2" x 12"	10/10
32530	52530	2-1/2" x 3"	20/40
32535	52535	2-1/2" x 3-1/2"	30/30
32540	52540	2-1/2" x 4"	30/30
32545	52545	2-1/2" x 4-1/2"	30/30
32550	52550	2-1/2" x 5"	20/20
32555	52555	2-1/2" x 5-1/2"	20/20
32560	52560	2-1/2" x 6"	20/20
32570	52570	2-1/2" x 7"	20/20
32580	52580	2-1/2" x 8"	10/10
32590	52590	2-1/2" x 9"	10/10
33000	53000	3" x Close	30/30
33010	53010	3" x 10"	5/5
33011	53011	3" x 11"	5/5
33012	53012	3" x 12"	5/5
33030	53030	3" x 3"	20/20
33035	53035	3" x 3-1/2"	15/15
33040	53040	3" x 4"	15/15
33045	53045	3" x 4-1/2"	15/15
33050	53050	3" x 5"	15/15
33055	53055	3" x 5-1/2"	15/15
33060	53060	3" x 6"	10/10
33070	53070	3" x 7"	7/7
33080	53080	3" x 8"	7/7
33090	—	3" x 9"	7/7
33500	—	3-1/2" x Close	20/20
33540	—	3-1/2" x 4"	10/10
33550	53550	3-1/2" x 5"	8/8
34000	54000	4" x Close	20/20
34010	54010	4" x 10"	4/4
34011	54011	4" x 11"	4/4
34012	54012	4" x 12"	4/4
34035	54035	4" x 3-1/2"	10/10
34040	54040	4" x 4"	10/10
34045	54045	4" x 4-1/2"	8/8
34050	54050	4" x 5"	8/8
34055	54055	4" x 5-1/2"	8/8
34060	54060	4" x 6"	8/8
34070	54070	4" x 7"	4/4
34080	54080	4" x 8"	4/4
34090	54090	4" x 9"	4/4
35045	—	5" x 4-1/2"	1/5
35050	—	5" x 5"	1/4
35055	—	5" x 5-1/2"	1/5
35060	—	5" x 6"	1/4
35070	—	5" x 7"	1/4
35080	—	5" x 8"	1/4
36000	56000	6" x Close	1/4

Pipe Nipples (cont.)

BLACK PART NO.	GALV. PART NO.	SIZE	CTN/MSTR
36010	56010	6" x 10"	1/3
36011	56011	6" x 11"	1/3
36012	56012	6" x 12"	3/3
36045	56045	6" x 4-1/2"	1/2
—	56050	6" x 5"	1/5
—	56055	6" x 5-1/2"	1/2
36060	56060	6" x 6"	1/2
36070	56070	6" x 7"	1/4
36080	56080	6" x 8"	1/4
36090	56090	6" x 9"	1/4
31210TOE	—	1-1/4" x 10"	20/40
31212TOE	—	1-1/4" x 12"	10/30

Installation Kit

Kit includes:

Size	Close	1-1/2"	2"	2-1/2"	3"	3-1/2"	4"	4-1/2"	5"	5-1/2"	6"
1/2"	1	1	1	1	1	1	1	1	1	1	1
3/4"	1	1	1	1	1	1	1	1	1	1	1
1"	1		1	1	1	1	1	1	1	1	1
1-1/4"	1		1	1	1	1	1	1	1	1	1
1-1/2"	1		1	1	1	1	1	1	1	1	1
2"	1			1	1	1	1	1	1	1	1

BLACK PART NO.	GALV. PART NO.	SIZE	CTN/MSTR
BI05	GI05	1/2"	1/1
BI07	GI07	3/4"	1/1
BI10	GI10	1"	1/1
BI12	GI12	1-1/4"	1/1
BI15	GI15	1-1/2"	1/1
BI20	—	2"	1/1

C-Assortment

Assortment includes:

Size	Close	1-1/2"	2"	2-1/2"	3"	3-1/2"	4"	4-1/2"	5"	5-1/2"	6"
1/2"	4	3	3	3	2	2	2	1	2	1	2
3/4"	6		4	3	2	2	2	1	2	1	2
1"	5		5	3	2	2	2	1	2	1	2

BLACK PART NO.	GALV. PART NO.	SIZE	CTN/MSTR
CB05	CG05	1/2"	1/1
CB07	CG07	3/4"	1/1
CB10	CG10	1"	1/1
CB12	—	1-1/4"	1/1
CB15	—	1-1/2"	1/1

A-Assortment

Assortment includes:

Size	Close	1-1/2"	2"	2-1/2"	3"	3-1/2"	4"	4-1/2"	5"	5-1/2"	6"
1/2"	20	10	15	10	10	5	10	5	5	5	5
3/4"	25		20	10	10	5	10	5	5	5	5
1"	15		12	5	12	3	12	3	5	3	5

BLACK PART NO.	GALV. PART NO.	SIZE	CTN/MSTR
AB05	AG05	1/2"	1/1
AB07	AG07	3/4"	1/1
—	AG10	1"	1/1

6-Pack Assortment

Assortment includes:

Size	Close	1-1/2"	2"	2-1/2"	3"	3-1/2"	4"	4-1/2"	5"	5-1/2"	6"
1/2"	6	6	6	6	6	6	6	6	6	6	6
3/4"	6	6	6	6	6	6	6	6	6	6	6
1"	6		6	6	6	6	6	6	6	6	6

BLACK PART NO.	GALV. PART NO.	SIZE	CTN/MSTR
605B	605G	1/2"	1/1
607B	607G	3/4"	1/1
610B	610G	1"	1/1

BG

Readycut Pipe



BLACK PART NO.	GALV. PART NO.	SIZE	CTN/MSTR
300B0218	301G0218	1/4"x18"	5/10
300B0224	301G0224	1/4"x24"	5/10
300B0230	301G0230	1/4"x30"	5/10
300B0236	301G0236	1/4"x36"	5/10
300B0248	301G0248	1/4"x48"	5/10
300B0260	301G0260	1/4"x60"	5/10
300B0272	—	1/4"x72"	5/10
300B0318	301G0318	3/8"x18"	5/10
300B0324	301G0324	3/8"x24"	5/10
300B0330	—	3/8"x30"	5/10
300B0336	301G0336	3/8"x36"	5/10
300B0348	301G0348	3/8"x48"	5/10
300B0360	301G0360	3/8"x60"	5/10
300B0372	—	3/8"x72"	5/10
300B0518	301G0518	1/2"x18"	5/10
300B0524	301G0524	1/2"x24"	5/10
300B0530	301G0530	1/2"x30"	5/10
300B0536	301G0536	1/2"x36"	5/10
300B0542	301G0542	1/2"x42"	5/10
300B0548	301G0548	1/2"x48"	5/10
300B0560	301G0560	1/2"x60"	5/10
300B0572	301G0572	1/2"x72"	5/10
300B0718	301G0718	3/4"x18"	5/10
300B0724	301G0724	3/4"x24"	5/10
300B0730	301G0730	3/4"x30"	5/10
300B0736	301G0736	3/4"x36"	5/10
300B0742	301G0742	3/4"x42"	5/10
300B0748	301G0748	3/4"x48"	5/10
300B0754	301G0754	3/4"x54"	5/10
300B0760	301G0760	3/4"x60"	5/10
300B0772	301G0772	3/4"x72"	5/10
300B1018	301G1018	1"x18"	5/10
300B1024	301G1024	1"x24"	5/10
300B1030	301G1030	1"x30"	5/10
300B1036	301G1036	1"x36"	5/10
—	301G1042	1"x42"	5/10
300B1048	301G1048	1"x48"	5/10
300B1060	301G1060	1"x60"	3/6
300B1066	—	1"x66"	3/6
300B1072	301G1072	1"x72"	3/6
300B1218	301G1218	1-1/4"x18"	3/6
—	301G1220	1-1/4"x20"	3/6
300B1224	301G1224	1-1/4"x24"	3/6
300B1230	301G1230	1-1/4"x30"	3/6
300B1236	301G1236	1-1/4"x36"	3/6
—	301G1242	1-1/4"x42"	3/6
300B1248	301G1248	1-1/4"x48"	3/6
300B1260	301G1260	1-1/4"x60"	3/6
300B1272	—	1-1/4"x72"	3/6
300B1518	301G1518	1-1/2"x18"	3/6
300B1524	301G1524	1-1/2"x24"	3/6

BG

Readycut Pipe (cont.)

BLACK PART NO.	GALV. PART NO.	SIZE	CTN/MSTR
300B1530	301G1530	1-1/2"x30"	3/6
300B1536	301G1536	1-1/2"x36"	3/6
300B1548	301G1548	1-1/2"x48"	3/6
300B1560	301G1560	1-1/2"x60"	3/6
300B1572	—	1-1/2"x72"	3/6
300B2018	301G2018	2"x18"	3/6
300B2024	301G2024	2"x24"	3/6
300B2030	301G2030	2"x30"	3/6
300B2036	301G2036	2"x36"	3/6
300B2042	—	2"x42"	3/6
300B2048	301G2048	2"x48"	3/6
300B2060	301G2060	2"x60"	3/6
300B2072	—	2"x72"	3/6
32518	—	2-1/2"x18"	3/6
32520	—	2-1/2"x20"	3/6
—	52524	2-1/2"x24"	3/6
300B2530	—	2-1/2"x30"	3/6
33018	301G3018	3"x18"	2/4
300B3024	301G3024	3"x24"	2/4
300B3036	—	3"x36"	2/4
300B4018	301G4018	4"x18"	2/2
34024	54024	4"x24"	2/2
—	301G4048	4"x48"	2/2
300B4060	—	4"x60"	2/2

Standard Merchant Coupling



BLACK PART NO.	GALV. PART NO.	SIZE	CTN/MSTR
M301	M101	1/8"	100/600
M302	M102	1/4"	100/500
M303	M103	3/8"	100/300
M305	M105	1/2"	100/250
M307	M107	3/4"	50/150
M310	M110	1"	30/100
M312	M112	1-1/4"	25/70
M315	M115	1-1/2"	25/60
M320	M120	2"	20/40
M325	M125	2-1/2"	10/20
M330	M130	3"	10/10
M340	M140	4"	10/5

Standard Merchant Half Coupling



BLACK PART NO.	GALV. PART NO.	SIZE	CTN/MSTR
H305	—	1/2"	1/500
H307	—	3/4"	1/300
H310	—	1"	1/200
H312	—	1-1/4"	1/140
H320	—	2"	1/80

BG

COPPER FITTINGS

Wrot/ACR Solder Fittings	363-369
Press Fittings	370-372
Forged Brass/Cast Pressure Fittings	373-374
Wrot DWV Solder Fittings.....	375
Cast DWV Solder Fittings.....	376-377
Cast Brass Flanges	378

CF

*Published March 2017. List prices can be found in list price book and on our website.

Wrot Male Adapter

C x M



PART NO.	ALT NO.	SIZE	CTN/MSTR
C75311	K151010001	1/8"	25/3000
C75312	K151010002	1/4"	25/1600
C75313	K151010025	3/8"	25/1000
C75314	K151010050	1/2"	25/600
C75315	K151010100	3/4"	25/250
C75316	K151010150	1"	10/150
C75317	K151010215	1-1/4"	110/110
C75318	K151010295	1-1/2"	65/65
C75319	K151010390	2"	38/38
C75320	K151010520	2-1/2"	48/48
C75321	K151010650	3"	36/36
C75322	K151010860	4"	12/12
C75323	K151010024	1/8" x 1/4"	25/2000
C75324	K151010007	1/4" x 1/8"	25/2000
C75325	K151010006	1/4" x 3/8"	25/750
C75326	K151010005	1/4" x 1/2"	25/600
C75327	K151010032	3/8" x 1/4"	25/750
C75328	K151010031	3/8" x 1/2"	25/500
C75329	K151010059	1/2" x 1/4"	25/1000
C75330	K151010058	1/2" x 3/8"	25/800
C75331	K151010057	1/2" x 3/4"	25/250
C75332	K151010056	1/2" x 1"	10/150
C75334	K151010092	5/8" x 3/4"	25/250
C75335	K151010107	3/4" x 1/2"	25/250
C75336	K151010106	3/4" x 1"	10/150
C75337	K151010160	1" x 1/2"	10/180
C75338	K151010159	1" x 3/4"	10/150
C75339	K151010158	1" x 1-1/4"	85/85
C75340	K151010157	1" x 1-1/2"	65/65
C75341	K151010223	1-1/4" x 3/4"	130/130
C75342	K151010222	1-1/4" x 1"	120/120
C75343	K151010221	1-1/4" x 1-1/2"	90/90
C75345	K151010304	1-1/2" x 1"	120/120
C75346	K151010303	1-1/2" x 1-1/4"	60/60
C75347	K151010302	1-1/2" x 2"	50/50
C75348	K151010399	2" x 1-1/4"	48/48
C75349	K151010398	2" x 1-1/2"	48/48
C75350	K151010531	2-1/2" x 2"	36/36

Wrot Fitting Male Adapter

Ftg x M



PART NO.	ALT NO.	SIZE	CTN/MSTR
C75352	K151140025	3/8"	25/800
C75353	K151140050	1/2"	25/500
C75354	K151140057	1/2" x 3/4"	25/250
C75355	K151140100	3/4"	25/250
C75356	K151140150	1"	10/130
C75357	K151140215	1-1/4"	80/80
C75358	K151140295	1-1/2"	50/50
C75359	K151140390	2"	38/38

Wrot Female Adapter

C x F



PART NO.	ALT NO.	SIZE	CTN/MSTR
C75111	K151050001	1/8"	25/1500
C75112	K151050002	1/4"	25/1000
C75113	K151050025	3/8"	25/800
C75114	K151050050	1/2"	25/450
C75115	K151050100	3/4"	25/200
C75116	K151050150	1"	10/140
C75117	K151050215	1-1/4"	80/80
C75118	K151050295	1-1/2"	60/60
C75119	K151050390	2"	36/36
C75120	K151050520	2-1/2"	48/48
C75121	K151050650	3"	30/30
C75122	K151050024	1/8" x 1/4"	25/1000
C75123	K151050006	1/4" x 3/8"	25/900
C75124	K151050032	3/8" x 1/4"	25/750
C75125	K151050031	3/8" x 1/2"	25/500
C75126	K151050060	1/2" x 1/8"	25/500
C75127	K151050059	1/2" x 1/4"	25/500
C75128	K151050058	1/2" x 3/8"	25/800
C75129	K151050057	1/2" x 3/4"	25/300
C75130	K151050056	1/2" x 1"	10/160
C75131	K151050093	5/8" x 1/2"	25/300
C75132	K151050092	5/8" x 3/4"	25/250
C75133	K151050107	3/4" x 1/2"	25/300
C75134	K151050106	3/4" x 1"	10/140
C75135	K151050160	1" x 1/2"	10/150
C75136	K151050159	1" x 3/4"	10/150
C75137	K151050158	1" x 1-1/4"	85/85
C75138	K151050223	1-1/4" x 3/4"	120/120
C75139	K151050222	1-1/4" x 1"	120/120
C75140	K151050221	1-1/4" x 1-1/2"	65/65
C75141	K151050303	1-1/2" x 1-1/4"	70/70
C75142	K151050302	1-1/2" x 2"	60/60
C75494	K151050398	2" x 1-1/2"	40/40

Wrot Fitting Female Adapter

Ftg x F



PART NO.	ALT NO.	SIZE	CTN/MSTR
C75392	K151150002	1/4"	25/1500
C75394	K151150050	1/2"	25/500
C75395	K151150100	3/4"	25/250
C75396	K151150150	1"	10/140
C75397	K151150215	1-1/4"	85/85
C75398	K151150295	1-1/2"	80/80
C75399	K151150390	2"	40/40
C75400	K151150058	1/2" x 3/8"	25/700
C75401	K151150057	1/2" x 3/4"	25/300

Wrot Flush Bushing

Ftg x F



PART NO.	ALT NO.	SIZE	CTN/MSTR
C75375	K151420060	1/2" x 1/8"	25/1500

Wrot Coupling (Socket) with Rolled Tube Stop

C x C



PART NO.	ALT NO.	SIZE	CTN/MSTR
C75000	K151650001	1/8"	25/3000
C75001	K151650002	1/4"	25/2000
C75566	K151650015	5/16" OD	25/3000
C75002	K151650025	3/8"	25/1200
C75003	K151650050	1/2"	25/800
C75004	K151650090	5/8"	25/400
C75005	K151650100	3/4"	25/300
C75006	K151650150	1"	10/150
C75007	K151650215	1-1/4"	100/100
C75008	K151650295	1-1/2"	60/60
C75009	K151650390	2"	40/40
C75010	K151650520	2-1/2"	50/50
C75011	K151650650	3"	30/30
C75012	K151650780	3-1/2"	18/18
C75013	K151650860	4"	20/20
C75477	K151651100	6"	3/3
C75478	K151651225	8"	1/1

Wrot Coupling (Socket) with Dimple Tube Stop

C x C



PART NO.	ALT NO.	SIZE	CTN/MSTR
C75550	K151700001	1/8"	25/3000
C75551	K151700002	1/4"	25/2000
C75553	K151700025	3/8"	25/1200
C75554	K151700050	1/2"	25/800
C75555	K151700090	5/8"	25/400
C75556	K151700100	3/4"	25/300
C75557	K151700150	1"	10/150
C75558	K151700215	1-1/4"	100/100
C75559	K151700295	1-1/2"	60/60
C75580	K151700390	2"	40/40
C75581	K151700520	2-1/2"	50/50
C75582	K151700650	3"	30/30
C75583	K151700780	3-1/2"	25/25
C75564	K151700860	4"	12/12
C75565	K151700975	5"	6/6
C75586	K151701100	6"	3/3

Wrot Coupling (Socket) less Tube Stop

C x C



PART NO.	ALT NO.	SIZE	CTN/MSTR
C75412	K151720001	1/8"	25/3000
C75413	K151720002	1/4"	25/2000
C75414	K151720025	3/8"	25/1200
C75415	K151720050	1/2"	25/800
C75519	K151720090	5/8"	25/400
C75416	K151720100	3/4"	25/300
C75417	K151720150	1"	10/150
C75418	K151720215	1-1/4"	100/100
C75419	K151720295	1-1/2"	60/60
C75420	K151720390	2"	40/40
C75421	K151720520	2-1/2"	50/50
C75422	K151720650	3"	30/30
C75423	K151720860	4"	12/12
C75424	K151720975	5"	6/6

Wrot Reducing Coupling

C x C



PART NO.	ALT NO.	SIZE	CTN/MSTR
C75069	K151650007	1/4" x 1/8"	25/2000
C75516	K151650008	1/4" OD x 3/16" OD	25/2000
C75070	K151650033	3/8" x 1/8"	25/800
C75071	K151650032	3/8" x 1/4"	25/800
C75073	K151650059	1/2" x 1/4"	25/800
C75074	K151650058	1/2" x 3/8"	25/800
C75075	K151650095	5/8" x 1/4"	25/500
C75076	K151650094	5/8" x 3/8"	25/500
C75077	K151650093	5/8" x 1/2"	25/500
C75078	K151650109	3/4" x 1/4"	25/400
C75079	K151650108	3/4" x 3/8"	25/400
C75080	K151650107	3/4" x 1/2"	25/350
C75081	K151650149	3/4" x 5/8"	25/350
C75517	K151650161	1" x 3/8"	10/200
C75082	K151650160	1" x 1/2"	10/200
C75083	K151651498	1" x 5/8"	10/180
C75084	K151650159	1" x 3/4"	10/160
C75085	K151650224	1-1/4" x 1/2"	100/100
C75086	K151650223	1-1/4" x 3/4"	100/100
C75087	K151650222	1-1/4" x 1"	100/100
C75088	K151650306	1-1/2" x 1/2"	100/100
C75089	K151650305	1-1/2" x 3/4"	100/100
C75090	K151650304	1-1/2" x 1"	100/100
C75091	K151650303	1-1/2" x 1-1/4"	100/100
C75092	K151650402	2" x 1/2"	50/50
C75093	K151650401	2" x 3/4"	50/50
C75094	K151650400	2" x 1"	50/50
C75095	K151650399	2" x 1-1/4"	50/50
C75096	K151650398	2" x 1-1/2"	50/50
C75097	K151650534	2-1/2" x 1"	30/30
C75098	K151650533	2-1/2" x 1-1/4"	30/30
C75099	K151650532	2-1/2" x 1-1/2"	30/30
C75100	K151650531	2-1/2" x 2"	30/30
C75101	K151650664	3" x 1-1/2"	20/20
C75102	K151650663	3" x 2"	20/20
C75103	K151650662	3" x 2-1/2"	15/15
C75104	K151650874	4" x 1-1/4"	20/20
C75105	K151650873	4" x 1-1/2"	20/20
C75106	K151650872	4" x 2"	18/18
C75107	K151650871	4" x 2-1/2"	18/18
C75108	K151650870	4" x 3"	18/18
C75109	K151651111	6" x 3"	4/4
C75110	K151651109	6" x 4"	4/4

Wrot Crossover Coupling

C x C



PART NO.	ALT NO.	SIZE	CTN/MSTR
C75548	K151670050	1/2"	180/180

Wrot Cap



PART NO.	ALT NO.	SIZE	CTN/MSTR
C75055	K151540001	1/8"	25/3300
C75056	K151540002	1/4"	25/3000
C75057	K151540025	3/8"	25/2500
C75058	K151540050	1/2"	25/1400
C75059	K151540090	5/8"	25/850
C75060	K151540100	3/4"	25/500
C75061	K151540150	1"	10/300
C75062	K151540215	1-1/4"	200/200
C75063	K151540295	1-1/2"	140/140
C75064	K151540390	2"	60/60
C75065	K151540520	2-1/2"	30/30
C75066	K151540650	3"	20/20
C75067	K151540860	4"	25/25
C75068	K151541100	6"	5/5

Wrot 90° Short Turn Elbow

C x C



PART NO.	ALT NO.	SIZE	CTN/MSTR
C75014	K152350001	1/8"	25/3000
C75015	K152350002	1/4"	25/1200
C75016	K152350025	3/8"	25/1000
C75030	K152350032	3/8" x 1/4"	25/800
C75017	K152350050	1/2"	25/500
C75031	K152350059	1/2" x 1/4"	25/500
C75018	K152350090	5/8"	25/300
C75019	K152350100	3/4"	25/200
C75033	K152350107	3/4" x 1/2"	25/200
C75020	K152350150	1"	10/100
C75034	K152350160	1" x 1/2"	10/80
C75035	K152350159	1" x 3/4"	10/80
C75021	K152350215	1-1/4"	50/50
C75522	K152350223	1-1/4" x 3/4"	50/50
C75036	K152350222	1-1/4" x 1"	50/50
C75022	K152350295	1-1/2"	35/35
C75037	K152350303	1-1/2" x 1-1/4"	35/35
C75023	K152350390	2"	17/17
C75038	K152350398	2" x 1-1/2"	17/17
C75024	K152350520	2-1/2"	20/20
C75025	K152350650	3"	13/13
C75523	K152350780	3-1/2"	7/7
C75026	K152350860	4"	6/6
C75027	K152350975	5"	2/2
C75028	K152351100	6"	1/1
C75029	K152351225	8"	1/1

Wrot 90° Long Turn Elbow

C x C



PART NO.	ALT NO.	SIZE	CTN/MSTR
C75481	K152420001	1/8"	25/2000
C75482	K152420002	1/4"	25/1200
C75540	K152420015	5/16" OD	25/1600
C75483	K152420025	3/8"	25/750
C75484	K152420050	1/2"	25/350
C75485	K152420090	5/8"	25/200
C75486	K152420100	3/4"	10/120
C75487	K152420150	1"	10/60
C75488	K152420215	1-1/4"	35/35
C75489	K152420295	1-1/2"	25/25
C75490	K152420390	2"	12/12
C75491	K152420520	2-1/2"	16/16
C75492	K152420650	3"	8/8
C75544	K152420860	4"	4/4

Wrot 90° Short Turn Street Elbow

Ftg x C



PART NO.	ALT NO.	SIZE	CTN/MSTR
C75377	K152540002	1/4"	25/1200
C75378	K152540025	3/8"	25/1000
C75379	K152540050	1/2"	25/500
C75380	K152540090	5/8"	25/300
C75381	K152540100	3/4"	25/200
C75382	K152540150	1"	10/100
C75383	K152540215	1-1/4"	50/50
C75384	K152540295	1-1/2"	35/35
C75385	K152540390	2"	17/17
C75386	K152540520	2-1/2"	20/20
C75387	K152540650	3"	13/13
C75388	K152540860	4"	25/1200

Wrot 90° Short Turn Street Elbow

Ftg x Ftg



PART NO.	ALT NO.	SIZE	CTN/MSTR
C75535	K152670050	1/2"	25/500
C75536	K152670100	3/4"	25/250

CF

Wrot 90° Long Turn Street Elbow

Ftg x C



PART NO.	ALT NO.	SIZE	CTN/MSTR
C75403	K152720002	1/4"	25/1200
C75404	K152720025	3/8"	25/750
C75405	K152720050	1/2"	25/350
C75406	K152720090	5/8"	25/200
C75407	K152720100	3/4"	10/120
C75408	K152720150	1"	10/60
C75409	K152720215	1-1/4"	35/35
C75410	K152720295	1-1/2"	25/25
C75411	K152720390	2"	12/12
C75479	K152720520	2-1/2"	16/16
C75546	K152720860	4"	6/6

Wrot 45° Elbow

C x C



PART NO.	ALT NO.	SIZE	CTN/MSTR
C75039	K152900001	1/8"	25/2000
C75040	K152900002	1/4"	25/2000
C75041	K152900025	3/8"	25/800
C75042	K152900050	1/2"	25/500
C75043	K152900090	5/8"	25/300
C75044	K152900100	3/4"	25/200
C75045	K152900150	1"	10/100
C75046	K152900215	1-1/4"	60/60
C75047	K152900295	1-1/2"	40/40
C75048	K152900390	2"	18/18
C75049	K152900520	2-1/2"	20/20
C75050	K152900650	3"	15/15
C75051	K152900860	4"	6/6
C75052	K152900975	5"	4/4
C75053	K152901100	6"	2/2

Wrot 45° Street Elbow

Ftg x C



PART NO.	ALT NO.	SIZE	CTN/MSTR
C75463	K152950002	1/4"	25/2000
C75464	K152950025	3/8"	25/800
C75465	K152950050	1/2"	25/500
C75466	K152950090	5/8"	25/300
C75467	K152950100	3/4"	25/200
C75468	K152950150	1"	10/100
C75469	K152950215	1-1/4"	60/60
C75470	K152950295	1-1/2"	40/40
C75471	K152950390	2"	18/18
C75472	K152950520	2-1/2"	20/20
C75473	K152950650	3"	15/15
C75474	K152950860	4"	6/6

Wrot Fitting Plug



PART NO.	ALT NO.	SIZE	CTN/MSTR
C75525	K153960050	1/2"	25/1400
C75527	K153960150	1"	10/300

Wrot Suction Line P-Trap

C x C



PART NO.	ALT NO.	SIZE	CTN/MSTR
K155330050	—	1/2"	5/60
K155330090	—	5/8"	5/60
K155330100	—	3/4"	40/40
K155330150	—	1"	3/15
K155330215	—	1-1/4"	2/10
K155330295	—	1-1/2"	2/6
K155330390	—	2"	1/4

Wrot Flush Bushing

Ftg x C



PART NO.	ALT NO.	SIZE	CTN/MSTR
C75360	K151400007	1/4" x 1/8"	25/3300
C75361	K151400032	3/8" x 1/4"	25/2500
C75363	K151400058	1/2" x 3/8"	25/1500
C75362	K151400059	1/2" x 1/4"	25/1500
C75568	K151400108	3/4" x 3/8"	25/700
C75366	K151400107	3/4" x 1/2"	25/700
C75367	K151400149	3/4" x 5/8"	25/500
C75368	K151400160	1" x 1/2"	10/320
C75370	K151400159	1" x 3/4"	10/300
C75371	K151400223	1-1/4" x 3/4"	200/200
C75372	K151400222	1-1/4" x 1"	200/200
C75373	K151400303	1-1/2" x 1-1/4"	140/140
C75374	K151400398	2" x 1-1/2"	60/60

CF

Wrot Fitting Reducer

Ftg x C



PART NO.	ALT NO.	SIZE	CTN/MSTR
C75425	K154100007	1/4" x 1/8"	25/3300
C75427	K154100032	3/8" x 1/4"	25/1200
C75428	K154100059	1/2" x 1/4"	25/1000
C75429	K154100058	1/2" x 3/8"	25/1000
C75430	K154100094	5/8" x 3/8"	25/500
C75431	K154100093	5/8" x 1/2"	25/500
C75432	K154100109	3/4" x 1/4"	25/400
C75433	K154100108	3/4" x 3/8"	25/400
C75434	K154100107	3/4" x 1/2"	25/400
C75435	K154100149	3/4" x 5/8"	25/400
C75437	K154100160	1" x 1/2"	10/200
C75438	K154101498	1" x 5/8"	10/200
C75439	K154100159	1" x 3/4"	10/160
C75440	K154100224	1-1/4" x 1/2"	100/100
C75441	K154100223	1-1/4" x 3/4"	100/100
C75442	K154100222	1-1/4" x 1"	100/100
C75443	K154100306	1-1/2" x 1/2"	100/100
C75444	K154100305	1-1/2" x 3/4"	100/100
C75445	K154100304	1-1/2" x 1"	100/100
C75446	K154100303	1-1/2" x 1-1/4"	100/100
C75447	K154100402	2" x 1/2"	50/50
C75448	K154100401	2" x 3/4"	50/50
C75449	K154100400	2" x 1"	50/50
C75450	K154100399	2" x 1-1/4"	50/50
C75451	K154100398	2" x 1-1/2"	50/50
C75452	K154100534	2-1/2" x 1"	30/30
C75453	K154100533	2-1/2" x 1-1/4"	30/30
C75454	K154100532	2-1/2" x 1-1/2"	30/30
C75455	K154100531	2-1/2" x 2"	30/30
C75456	K154100665	3" x 1-1/4"	20/20
C75457	K154100664	3" x 1-1/2"	20/20
C75458	K154100663	3" x 2"	20/20
C75459	K154100662	3" x 2-1/2"	15/15
C75460	K154100872	4" x 2"	18/18
C75461	K154100871	4" x 2-1/2"	18/18
C75462	K154100870	4" x 3"	18/18
C75562	K154100869	4" x 3-1/2"	15/15
C75563	K154100983	5" x 4"	12/12

Wrot Union

C x C



PART NO.	ALT NO.	SIZE	CTN/MSTR
C75502	K156570050	1/2"	25/200
C75503	K156570100	3/4"	25/100
C75504	K156570150	1"	10/70
C75505	K126570215	1-1/4"	50/50
C75506	K126570295	1-1/2"	30/30
C75507	K126570390	2"	18/18
C75508	K126570520	2-1/2"	8/8
C75509	K126570650	3"	6/6

Wrot U-Type Strap



PART NO.	ALT NO.	SIZE	CTN/MSTR
K159470001	—	1/8"	25/2000
K159470002	—	1/4"	25/1500
K159470025	—	3/8"	25/1300
K159470050	—	1/2"	25/1000
K159470090	—	5/8"	25/500
K159470100	—	3/4"	25/600
K159470150	—	1"	10/350
K159470215	—	1-1/4"	1/350
K159470295	—	1-1/2"	300/300
K159470390	—	2"	300/300



Wrot Tee

C x C x C



PART NO.	ALT NO.	SIZE	CTN/MSTR
C75143	K154600001	1/8"	25/2000
C75144	K154600002	1/4"	25/1300
C75162	K154600007	1/4" x 1/4" x 1/8"	25/1300
C75163	K154600006	1/4" x 1/4" x 3/8"	25/1300
C75160	K154600013	1/4" x 1/8" x 1/8"	25/1500
C75161	K154600012	1/4" x 1/8" x 1/4"	25/1300
C75145	K154600025	3/8"	25/600
C75166	K154600041	3/8" x 1/4" x 1/4"	25/500
C75167	K154600033	3/8" x 3/8" x 1/8"	25/600
C75168	K154600032	3/8" x 3/8" x 1/4"	25/600
C75169	K154600031	3/8" x 3/8" x 1/2"	25/350
C75146	K154600050	1/2"	50/500
C75170	K154600075	1/2" x 1/4" x 1/2"	25/400
C75171	K154600068	1/2" x 3/8" x 1/4"	25/400
C75173	K154600066	1/2" x 3/8" x 1/2"	25/350
C75174	K154600060	1/2" x 1/2" x 1/8"	25/400
C75175	K154600059	1/2" x 1/2" x 1/4"	25/400
C75176	K154600058	1/2" x 1/2" x 3/8"	25/400
C75177	K154600057	1/2" x 1/2" x 3/4"	10/180
C75178	K154600056	1/2" x 1/2" x 1"	10/70
C75147	K154600090	5/8"	25/200
C75571	K154600095	5/8" x 5/8" x 1/4"	25/200
C75181	K154600092	5/8" x 5/8" x 3/4"	25/200
C75148	K154600100	3/4"	20/160
C75572	K154600127	3/4" x 3/8" x 1/2"	10/170
C75182	K154600118	3/4" x 1/2" x 1/2"	10/180
C75183	K154600117	3/4" x 1/2" x 3/4"	10/120
C75184	K154600109	3/4" x 3/4" x 1/4"	10/170
C75185	K154600108	3/4" x 3/4" x 3/8"	10/170
C75186	K154600107	3/4" x 3/4" x 1/2"	10/170
C75188	K154600106	3/4" x 3/4" x 1"	10/80
C75149	K154600150	1"	10/60
C75195	K154600161	1" x 1" x 3/8"	10/100
C75196	K154600160	1" x 1" x 1/2"	10/100
C75198	K154600159	1" x 1" x 3/4"	10/60
C75199	K154600158	1" x 1" x 1-1/4"	35/35
C75200	K154600157	1" x 1" x 1-1/2"	25/25
C75192	K154600171	1" x 3/4" x 1/2"	10/60
C75193	K154600170	1" x 3/4" x 3/4"	10/60
C75194	K154600169	1" x 3/4" x 1"	10/60
C75189	K154600182	1" x 1/2" x 1/2"	10/100
C75190	K154600181	1" x 1/2" x 3/4"	10/80
C75191	K154600180	1" x 1/2" x 1"	10/60
C75197	K154601498	1" x 1" x 5/8"	10/70
C75150	K154600215	1-1/4"	35/35
C75202	K154600256	1-1/4" x 1/2" x 1-1/4"	35/35
C75203	K154600248	1-1/4" x 3/4" x 1/2"	50/50
C75204	K154600247	1-1/4" x 3/4" x 3/4"	50/50
C75205	K154600246	1-1/4" x 3/4" x 1"	45/45
C75206	K154600245	1-1/4" x 3/4" x 1-1/4"	35/35

Wrot Tee (cont.)

PART NO.	ALT NO.	SIZE	CTN/MSTR
C75207	K154600237	1-1/4" x 1" x 1/2"	60/60
C75208	K154600236	1-1/4" x 1" x 3/4"	50/50
C75209	K154600235	1-1/4" x 1" x 1"	50/50
C75210	K154600234	1-1/4" x 1" x 1-1/4"	30/30
C75211	K154600224	1-1/4" x 1-1/4" x 1/2"	50/50
C75212	K154600223	1-1/4" x 1-1/4" x 3/4"	50/50
C75213	K154600222	1-1/4" x 1-1/4" x 1"	40/40
C75214	K154600221	1-1/4" x 1-1/4" x 1-1/2"	20/20
C75215	K154600220	1-1/4" x 1-1/4" x 2"	10/10
C75151	K154600295	1-1/2"	20/20
C75233	K154600306	1-1/2" x 1-1/2" x 1/2"	40/40
C75234	K154600305	1-1/2" x 1-1/2" x 3/4"	35/35
C75235	K154600304	1-1/2" x 1-1/2" x 1"	35/35
C75236	K154600303	1-1/2" x 1-1/2" x 1-1/4"	25/25
C75237	K154600302	1-1/2" x 1-1/2" x 2"	10/10
C75228	K154600319	1-1/2" x 1-1/4" x 1/2"	10/40
C75229	K154600318	1-1/2" x 1-1/4" x 3/4"	40/40
C75230	K154600317	1-1/2" x 1-1/4" x 1"	30/30
C75231	K154600316	1-1/2" x 1-1/4" x 1-1/4"	30/30
C75232	K154600315	1-1/2" x 1-1/4" x 1-1/2"	20/20
C75223	K154600332	1-1/2" x 1" x 1/2"	40/40
C75225	K154600331	1-1/2" x 1" x 3/4"	40/40
C75224	K154600330	1-1/2" x 1" x 1"	35/35
C75226	K154600329	1-1/2" x 1" x 1-1/4"	30/30
C75227	K154600328	1-1/2" x 1" x 1-1/2"	20/20
C75218	K154600343	1-1/2" x 3/4" x 1/2"	40/40
C75219	K154600342	1-1/2" x 3/4" x 3/4"	30/30
C75220	K154600341	1-1/2" x 3/4" x 1"	40/40
C75221	K154600340	1-1/2" x 3/4" x 1-1/4"	30/30
C75222	K154600339	1-1/2" x 3/4" x 1-1/2"	20/20
C75216	K154600352	1-1/2" x 1/2" x 1"	40/40
C75217	K154600350	1-1/2" x 1/2" x 1-1/2"	20/20
C75152	K154600390	2"	10/10
C75254	K154600402	2" x 2" x 1/2"	20/20
C75255	K154600401	2" x 2" x 3/4"	20/20
C75256	K154600400	2" x 2" x 1"	18/18
C75257	K154600399	2" x 2" x 1-1/4"	15/15
C75258	K154600398	2" x 2" x 1-1/2"	10/10
C75259	K154600397	2" x 2" x 2-1/2"	15/15
C75248	K154600418	2" x 1-1/2" x 1/2"	20/20
C75249	K154600417	2" x 1-1/2" x 3/4"	20/20
C75250	K154600416	2" x 1-1/2" x 1"	20/20
C75251	K154600415	2" x 1-1/2" x 1-1/4"	10/10
C75252	K154600414	2" x 1-1/2" x 1-1/2"	15/15
C75253	K154600413	2" x 1-1/2" x 2"	10/10
C75243	K154600433	2" x 1-1/4" x 3/4"	20/20
C75244	K154600432	2" x 1-1/4" x 1"	20/20
C75245	K154600431	2" x 1-1/4" x 1-1/4"	15/15
C75246	K154600430	2" x 1-1/4" x 1-1/2"	15/15
C75247	K154600429	2" x 1-1/4" x 2"	10/10
C75240	K154600447	2" x 1" x 1"	20/20
C75242	K154600444	2" x 1" x 2"	15/15
C75238	K154600470	2" x 1/2" x 2"	15/15
C75239	K154600457	2" x 3/4" x 2"	10/10
C75153	K154600520	2-1/2"	15/15
C75260	K154600608	2-1/2" x 3/4" x 2-1/2"	15/15

CF

Wrot Tee (cont.)

PART NO.	ALT NO.	SIZE	CTN/MSTR
C75261	K154600595	2-1/2" x 1" x 2-1/2"	15/15
C75262	K154600583	2-1/2" x 1-1/4" x 1-1/4"	20/20
C75263	K154600580	2-1/2" x 1-1/4" x 2-1/2"	15/15
C75573	K154600566	2-1/2" x 1-1/2" x 1-1/2"	10/10
C75574	K154600565	2-1/2" x 1-1/2" x 2"	15/15
C75264	K154600564	2-1/2" x 1-1/2" x 2-1/2"	15/15
C75265	K154600554	2-1/2" x 2" x 1/2"	20/20
C75266	K154600553	2-1/2" x 2" x 3/4"	20/20
C75267	K154600552	2-1/2" x 2" x 1"	20/20
C75268	K154600551	2-1/2" x 2" x 1-1/4"	20/20
C75269	K154600550	2-1/2" x 2" x 1-1/2"	20/20
C75270	K154600549	2-1/2" x 2" x 2"	15/15
C75271	K154600548	2-1/2" x 2" x 2-1/2"	15/15
C75272	K154600536	2-1/2" x 2-1/2" x 1/2"	25/25
C75273	K154600535	2-1/2" x 2-1/2" x 3/4"	25/25
C75274	K154600534	2-1/2" x 2-1/2" x 1"	25/25
C75275	K154600533	2-1/2" x 2-1/2" x 1-1/4"	20/20
C75276	K154600532	2-1/2" x 2-1/2" x 1-1/2"	20/20
C75277	K154600531	2-1/2" x 2-1/2" x 2"	15/15
C75154	K154600650	3"	10/10
C75281	K154600708	3" x 1-1/2" x 3"	8/8
C75282	K154600696	3" x 2" x 1-1/2"	10/10
C75283	K154600695	3" x 2" x 2"	15/15
C75285	K154600694	3" x 2" x 2-1/2"	10/10
C75286	K154600693	3" x 2" x 3"	10/10
C75576	K154600682	3" x 2-1/2" x 1"	25/25
C75288	K154600680	3" x 2-1/2" x 1-1/2"	15/15
C75289	K154600679	3" x 2-1/2" x 2"	15/15
C75290	K154600678	3" x 2-1/2" x 2-1/2"	10/10
C75291	K154600677	3" x 2-1/2" x 3"	10/10
C75292	K154600668	3" x 3" x 1/2"	10/10
C75293	K154600667	3" x 3" x 3/4"	20/20
C75294	K154600666	3" x 3" x 1"	20/20
C75295	K154600665	3" x 3" x 1-1/4"	15/15
C75296	K154600664	3" x 3" x 1-1/2"	15/15
C75297	K154600663	3" x 3" x 2"	13/13
C75298	K154600662	3" x 3" x 2-1/2"	10/10
C75155	K154600860	4"	5/5
C75299	K154600914	4" x 2" x 4"	4/4
C75300	K154600896	4" x 3" x 2-1/2"	5/5
C75301	K154600895	4" x 3" x 3"	5/5
C75302	K154600893	4" x 3" x 4"	5/5
C75303	K154600877	4" x 4" x 1/2"	5/5
C75304	K154600876	4" x 4" x 3/4"	8/8
C75305	K154600875	4" x 4" x 1"	8/8
C75306	K154600874	4" x 4" x 1-1/4"	8/8
C75307	K154600873	4" x 4" x 1-1/2"	8/8
C75308	K154600872	4" x 4" x 2"	6/6
C75309	K154600871	4" x 4" x 2-1/2"	5/5
C75310	K154600870	4" x 4" x 3"	5/5
C75156	K154600975	5"	2/2
C75157	K154601100	6"	1/1
C75577	K154601113	6" x 6" x 2"	2/2
C75578	K154601111	6" x 6" x 3"	2/2
C75579	K154601109	6" x 6" x 4"	2/2
C75158	K154601225	8"	1/1

CF

Copper Press Coupling (Socket) with Rolled Tube Stop

P x P

New!



PART NO.	SIZE	CTN/MSTR
C77001	1/2" x 1/2"	10/550
C77002	3/4" x 3/4"	10/260
C77003	1" x 1"	5/170
C77004	1-1/4" x 1-1/4"	1/80
C77005	1-1/2" x 1-1/2"	1/50
C77006	2" x 2"	1/35
C77007	2-1/2" x 2-1/2"	1/32
C77008	3" x 3"	1/18
C77009	4" x 4"	1/12

Copper Press Coupling (Socket) Less Stop

P x P

New!



PART NO.	SIZE	CTN/MSTR
C77010	1/2" x 1/2"	10/450
C77011	3/4" x 3/4"	10/260
C77012	1" x 1"	5/170
C77013	1-1/4" x 1-1/4"	1/80
C77014	1-1/2" x 1-1/2"	1/50
C77015	2" x 2"	1/35
C77016	2-1/2" x 2-1/2"	1/32
C77017	3" x 3"	1/18
C77018	4" x 4"	1/12

Copper Press Reducer

P x P

New!



PART NO.	SIZE	CTN/MSTR
C77019	3/4" x 1/2"	10/300
C77020	1" x 3/4"	10/200
C77021	1-1/4" x 1"	1/80
C77022	1-1/2" x 1-1/4"	1/60
C77023	2" x 1-1/2"	1/40

Copper Press 45° Elbow

P x P

New!



PART NO.	SIZE	CTN/MSTR
C77044	1/2" x 1/2"	10/400
C77045	3/4" x 3/4"	10/200
C77046	1" x 1"	5/140
C77047	1-1/4" x 1-1/4"	1/70
C77048	1-1/2" x 1-1/2"	1/40
C77049	2" x 2"	1/25
C77050	2-1/2" x 2-1/2"	1/16
C77051	3" x 3"	1/12
C77052	4" x 4"	1/6

Copper Press 45° Street Elbow

P x Ftg

New!



PART NO.	SIZE	CTN/MSTR
C77053	1/2" x 1/2"	10/450
C77054	3/4" x 3/4"	10/260
C77055	1" x 1"	5/140
C77056	1-1/4" x 1-1/4"	1/70
C77057	1-1/2" x 1-1/2"	1/40
C77058	2" x 2"	1/25
C77059	2-1/2" x 2-1/2"	1/18
C77060	3" x 3"	1/12
C77061	4" x 4"	1/6

Copper Press 90° Elbow

P x P

New!



PART NO.	SIZE	CTN/MSTR
C77062	1/2" x 1/2"	10/350
C77063	3/4" x 3/4"	10/180
C77064	1" x 1"	5/100
C77065	1-1/4" x 1-1/4"	1/55
C77066	1-1/2" x 1-1/2"	1/35
C77067	2" x 2"	1/18
C77068	2-1/2" x 2-1/2"	1/12
C77069	3" x 3"	1/9
C77070	4" x 4"	1/4

CF

Copper Press 90° Street Elbow

P x Ftg

New!



PART NO.	SIZE	CTN/MSTR
C77071	1/2" x 1/2"	10/400
C77072	3/4" x 3/4"	10/200
C77073	1" x 1"	5/100
C77074	1-1/4" x 1-1/4"	1/55
C77075	1-1/2" x 1-1/2"	1/35
C77076	2" x 2"	1/20
C77077	2-1/2" x 2-1/2"	1/14
C77078	3" x 3"	1/9
C77079	4" x 4"	1/4

Copper Press Cap

P

New!



PART NO.	SIZE	CTN/MSTR
C77218	1/2"	10/450
C77219	3/4"	10/450
C77220	1"	5/250
C77221	1-1/4"	1/100
C77222	1-1/2"	1/80
C77223	2"	1/55
C77224	2-1/2"	1/40
C77225	3"	1/36
C77226	4"	1/24

Copper Press Female Adapter

P x FPT

New!



PART NO.	SIZE	CTN/MSTR
C77149	1/2" x 1/2"	10/300
C77173	3/4" x 1/2"	10/180
C77150	3/4" x 3/4"	10/150
C77151	1" x 1"	10/180
C77152	1-1/4" x 1-1/4"	1/80
C77153	1-1/2" x 1-1/2"	1/55
C77154	2" x 2"	1/40
C77155	1/2" x 3/4"	10/180
C77159	1" x 3/4"	10/200
C77162	1-1/4" x 1"	1/100

Copper Press Female Fitting Adapter

FTG x FPT

New!



PART NO.	SIZE	CTN/MSTR
C77165	1/2" x 1/2"	5/250
C77166	3/4" x 3/4"	5/150
C77167	1" x 1"	1/110
C77168	1-1/4" x 1-1/4"	1/80
C77169	1-1/2" x 1-1/2"	1/55
C77170	2" x 2"	1/40

Copper Press Male Adapter

P x MPT

New!



PART NO.	SIZE	CTN/MSTR
C77174	1/2" x 1/2"	10/300
C77175	3/4" x 3/4"	10/160
C77176	1" x 1"	10/160
C77177	1-1/4" x 1-1/4"	1/100
C77178	1-1/2" x 1-1/2"	1/50
C77179	2" x 2"	1/35
C77180	2-1/2" x 2-1/2"	1/28
C77181	3" x 3"	1/18
C77182	4" x 4"	1/12
C77183	1/2" x 3/4"	10/180
C77185	3/4" x 1/2"	10/180
C77186	1" x 1-1/4"	10/100
C77187	1" x 3/4"	10/180
C77188	1-1/4" x 1-1/2"	1/55
C77189	1-1/4" x 1"	1/95
C77190	1-1/2" x 1-1/4"	1/55

Copper Press Male Fitting Adapter

FTG x MPT

New!



PART NO.	SIZE	CTN/MSTR
C77191	1/2" x 1/2"	5/250
C77199	3/4" x 1/2"	5/180
C77192	3/4" x 3/4"	5/160
C77193	1" x 1"	5/200
C77194	1-1/4" x 1-1/4"	1/80
C77195	1-1/2" x 1-1/2"	1/60
C77196	2" x 2"	1/40

CF

Copper Press Fitting Reducer

P x Ftg

New!



PART NO.	SIZE	CTN/MSTR
C77131	3/4" x 1/2"	10/400
C77132	1" x 1/2"	10/300
C77133	1" x 3/4"	10/240
C77134	1-1/4" x 1"	5/150
C77135	1-1/4" x 3/4"	5/170
C77136	1-1/2" x 1-1/4"	1/70
C77137	1-1/2" x 1"	1/70
C77138	2" x 1-1/2"	1/40
C77139	2" x 1-1/4"	1/50
C77140	2" x 1"	1/50
C77141	2-1/2" x 2"	1/35
C77142	3" x 2-1/2"	1/24
C77143	3" x 2"	1/24
C77144	4" x 3"	1/10
C77145	4" x 2-1/2"	1/10
C77146	4" x 2"	1/12

Copper Press Tee

P x P x P

New!



PART NO.	SIZE	CTN/MSTR
C77080	1/2" x 1/2" x 1/2"	10/200
C77081	3/4" x 3/4" x 3/4"	10/120
C77082	1" x 1" x 1"	5/70
C77083	1-1/4" x 1-1/4" x 1-1/4"	1/45
C77084	1-1/2" x 1-1/2" x 1-1/2"	1/25
C77085	2" x 2" x 2"	1/15
C77086	2-1/2" x 2-1/2" x 2-1/2"	1/10
C77087	3" x 3" x 3"	1/7
C77088	4" x 4" x 4"	1/4
C77091	3/4" x 1/2" x 3/4"	5/120
C77092	3/4" x 3/4" x 1/2"	10/140
C77093	3/4" x 1/2" x 1/2"	10/150
C77094	1" x 3/4" x 1"	5/70
C77095	1" x 1/2" x 1"	5/80
C77096	1" x 1" x 3/4"	5/80
C77097	1" x 3/4" x 3/4"	5/100
C77098	1" x 1" x 1/2"	5/100
C77099	1" x 3/4" x 1/2"	5/100
C77100	1-1/4" x 1-1/4" x 1"	1/50
C77101	1-1/4" x 1" x 1"	1/50
C77102	1-1/4" x 1-1/4" x 3/4"	1/55
C77103	1-1/4" x 1" x 3/4"	1/45
C77104	1-1/4" x 1-1/4" x 1/2"	1/60
C77105	1-1/2" x 1-1/2" x 1-1/4"	1/30
C77106	1-1/2" x 1-1/4" x 1-1/4"	1/30
C77107	1-1/2" x 1-1/2" x 1"	1/35
C77108	1-1/2" x 1-1/2" x 3/4"	1/35
C77109	2" x 2" x 1-1/4"	1/20
C77110	2" x 2" x 1-1/2"	1/16
C77113	2-1/2" x 2-1/2" x 2"	1/12
C77114	3" x 3" x 2-1/2"	1/7
C77115	3" x 3" x 2"	1/10
C77116	4" x 4" x 3"	1/4
C77117	4" x 4" x 2-1/2"	1/4
C77118	4" x 4" x 2"	1/6

Brass Male Adapter

C x M



PART NO.	SIZE	CTN/MSTR
K101010050	1/2"	50/200
K101010100	3/4"	25/150
K101010295	1-1/2" cast	10/50
K101010390	2" cast	5/50

Brass Female Adapter

C x F



PART NO.	SIZE	CTN/MSTR
K101050100	3/4"	25/150

Brass Drain Coupling with Cap

C x C



PART NO.	SIZE	CTN/MSTR
K101750100	3/4" cast	25/200

Brass 90° Flanged Sink Elbow

C x F



PART NO.	SIZE	CTN/MSTR
K102600050	1/2"	25/100

Brass 90° Drop Elbow

C x F



PART NO.	SIZE	CTN/MSTR
K102590050	1/2"	25/200
K102590058	1/2" x 3/8"	25/200

Brass 90° Elbow

C x M



PART NO.	SIZE	CTN/MSTR
K102550050	1/2"	50/200
K102550058	1/2" x 3/8"	50/250
K102550100	3/4"	25/150
K102550150	1"	10/80

C x F



PART NO.	SIZE	CTN/MSTR
K102570050	1/2"	50/250
K102570058	1/2" x 3/8"	25/250
K102570100	3/4"	25/100
K102570107	3/4" x 1/2"	25/200
K102570150	1"	10/50

Brass Drop Tee

C x C x C



PART NO.	SIZE	CTN/MSTR
K104670050	1/2"	25/250

C x C x F



PART NO.	SIZE	CTN/MSTR
K104820050	1/2"	25/150

CF

Brass Tee

C x C x F



PART NO.	SIZE	CTN/MSTR
K104800050	1/2"	25/200
K104800057	1/2" x 1/2" x 3/4"	25/200
K104800058	1/2" x 1/2" x 3/8"	25/200
K104800100	3/4"	10/100
K104800107	3/4" x 3/4" x 1/2"	25/100
K104800159	1" x 1" x 3/4"	10/80
K104800160	1" x 1" x 1/2"	10/100
K104800222	1-1/4" x 1-1/4" x 1" cast	1/25
K104800223	1-1/4" x 1-1/4" x 3/4"	10/50
K104800224	1-1/4" x 1-1/4" x 1/2"	10/50

C x F x C



PART NO.	SIZE	CTN/MSTR
K104920050	1/2"	25/300
K104920100	3/4"	10/100

F x F x C



PART NO.	SIZE	CTN/MSTR
K104980118	3/4" x 1/2" x 1/2"	10/100

Brass Baseboard Tee

C x F x C

CF



PART NO.	SIZE	CTN/MSTR
K104920143	3/4" x 1/8" x 3/4"	25/100

Brass Union

C x M



PART NO.	SIZE	CTN/MSTR
K126610050	1/2"	25/200
K126610100	3/4"	10/100
K126610150	1"	10/50
K126610215	1-1/4"	5/30
K126610295	1-1/2"	1/50
K126610390	2"	1/25

C x F



PART NO.	SIZE	CTN/MSTR
K126650050	1/2"	25/200
K126650100	3/4"	25/100
K126650150	1"	10/100
K126650215	1-1/4"	5/40
K126650295	1-1/2"	1/50

Wrot DWV Male Adapter



PART NO.	SIZE	CTN/MSTR
161010295	1-1/2"	10/100
161010390	2"	5/100

Wrot DWV Female Adapter



PART NO.	SIZE	CTN/MSTR
161050215	1-1/4"	150/150
161050295	1-1/2"	10/100
161050390	2"	10/100

Wrot DWV Test Cap



PART NO.	SIZE	CTN/MSTR
161570050	1/2"	1/1
161570100	3/4"	1/1
161570150	1"	400/400
161570215	1-1/4"	50/600
161570295	1-1/2"	50/600
161570390	2"	50/100
161570650	3"	25/200

Wrot DWV Tee



PART NO.	SIZE	CTN/MSTR
164600390	2"	16/16
164600398	2" x 1-1/2"	5/50

Wrot DWV Coupling with Stop



PART NO.	SIZE	CTN/MSTR
161650215	1-1/4"	25/250
161650295	1-1/2"	130/130
161650303	1-1/2" x 1-1/4"	25/300
161650390	2"	250/250
161650398	2" x 1-1/2"	10/100
161650399	2" x 1-1/4"	10/100
161650650	3"	80/80
161650663	3" x 2"	5/100

Wrot DWV Coupling less Stop



PART NO.	SIZE	CTN/MSTR
161720215	1-1/4"	25/200
161720295	1-1/2"	25/200
161720390	2"	100/100
161720650	3"	1/1

Wrot DWV 90° Elbow



PART NO.	SIZE	CTN/MSTR
162350215	1-1/4"	80/80
162350295	1-1/2"	40/40
162350390	2"	20/20

Wrot DWV 90° Long Turn Elbow



PART NO.	SIZE	CTN/MSTR
162420295	1-1/2"	1/1

Wrot DWV 90° Street Elbow



PART NO.	SIZE	CTN/MSTR
162540215	1-1/4"	200/200
162540295	1-1/2"	50/50
162540390	2"	50/50

Wrot DWV 45° Elbow



PART NO.	SIZE	CTN/MSTR
162900215	1-1/4"	120/120
162900295	1-1/2"	60/60
162900390	2"	30/30
162900650	3"	2/2

Wrot DWV 45° Street Elbow



PART NO.	SIZE	CTN/MSTR
162950215	1-1/4"	120/120
162950295	1-1/2"	60/60
162950390	2"	30/30

Wrot DWV Fitting Reducer



PART NO.	SIZE	CTN/MSTR
164100303	1-1/2" x 1-1/4"	25/250
164100398	2" x 1-1/2"	10/100
164100399	2" x 1-1/4"	1/1
164100663	3" x 2"	1/50
164100664	3" x 1-1/2"	5/50

CF

Cast DWV Male Adapter

C x M



PART NO.	SIZE	CTN/MSTR
K201010215	1-1/4"	10/300
K201010295	1-1/2"	10/100
K201010390	2"	60/60
K201010650	3"	1/20

Cast DWV Female Adapter

C x F



PART NO.	SIZE	CTN/MSTR
K201050295	1-1/2"	10/150
K201050650	3"	1/25

Cast DWV Soil Pipe Adapter

C x Spg



PART NO.	SIZE	CTN/MSTR
K201100390	2"	50/50

Cast DWV Fitting Cleanout

Ftg x Cleanout with Plug



PART NO.	SIZE	CTN/MSTR
K201610215	1-1/4"	120/120
K201610295	1-1/2"	1/100
K201610390	2"	60/60

Cast DWV Flush Fitting Cleanout

Ftg x Cleanout with Plug



PART NO.	SIZE	CTN/MSTR
K201620215	1-1/4"	25/25
K201620650	3"	25/25

Cast DWV 90° Elbow

C x C



PART NO.	SIZE	CTN/MSTR
K202350398	2" x 1-1/2"	25/25
K202350650	3"	10/10

Cast DWV 45° Elbow

Ftg x C



PART NO.	SIZE	CTN/MSTR
K202950650	3"	1/25

Cast DWV 22-1/2° Elbow

C x C



PART NO.	SIZE	CTN/MSTR
K203100295	1-1/2"	1/1

Cast DWV Tee

C x C x C



PART NO.	SIZE	CTN/MSTR
K204600215	1-1/4"	50/50
K204600295	1-1/2"	60/60
K204600390	2"	25/25
K204600398	2" x 1-1/2"	40/40
K204600414	2" x 1-1/2" x 1-1/2"	50/50

C x C x F



PART NO.	SIZE	CTN/MSTR
K204800295	1-1/2"	60/60

CF

Cast DWV Test Tee

C x C x Cleanout with Plug



PART NO.	SIZE	CTN/MSTR
K204850295	1-1/2"	1/50
K204850390	2"	1/25

Cast DWV Double Tee

C x C x C x C



PART NO.	SIZE	CTN/MSTR
K204650295	1-1/2"	25/25
K204650390	2"	1/25
K204650398	2" x 1-1/2"	1/1
K204650695	3" x 2"	1/15

Cast DWV Wye

C x C x C



PART NO.	SIZE	CTN/MSTR
K208400215	1-1/4"	1/1
K208400295	1-1/2"	1/50
K208400303	1-1/2" x 1-1/4"	1/1
K208400390	2"	1/25
K208400398	2" x 1-1/2"	1/50
K208400399	2" x 1-1/4"	1/50
K208400413	2" x 1-1/2" x 2"	1/50
K208400650	3"	1/1
K208400664	3" x 3" x 1-1/2"	1/1

Cast DWV Double Wye

C x C x C x C



PART NO.	SIZE	CTN/MSTR
K208450295	1-1/2"	1/50
K208450650	3"	1/10

Cast DWV Double Long Turn Tee-Wye

C x C x C x C



PART NO.	SIZE	CTN/MSTR
K205220390	2"	1/25

Cast DWV P-Trap

C x C



PART NO.	SIZE	CTN/MSTR
K245500295	1-1/2"	1/1
K245500390	2"	1/20

C x SJ



PART NO.	SIZE	CTN/MSTR
K245540295	1-1/2"	1/25

Cast DWV P-Trap with Cleanout

C x C x Cleanout with Plug



PART NO.	SIZE	CTN/MSTR
K245510215	1-1/4"	1/50
K245510295	1-1/2"	20/20
K245510390	2"	1/25

125# Cast Brass Companion Flange with A.S.M.E. Drilling

Copper Sweat



PART NO.	SIZE	CTN/MSTR
K113420215	1-1/4"	45/45
K113420520	2-1/2"	12/12
K113420650	3"	6/6
K113420860	4"	6/6

150# Cast Brass Companion Flange with A.S.M.E. Drilling

Copper Sweat



PART NO.	SIZE	CTN/MSTR
K113450390	2"	15/15
K113450650	3"	6/6
K113450860	4"	3/3

- IAPMO & NSF-61 CERTIFICATIONS
- MEETS STRICT ANSI SPECS
- MATERIAL SPECIFICATIONS TO ASTM B88
- CARTON QUANTITIES ONLY

NOMINAL PLUMBING TO REFRIGERATION HVAC

NOMINAL (I.D.) PLUMBING SIZE	REFRIGERATION (O.D.) HVAC SIZE
1/8"	1/4"
1/4"	3/8"
3/8"	1/2"
5/8"	3/4"
3/4"	7/8"
1"	1-1/8"
1-1/4"	1-3/8"
1-1/2"	1-5/8"
2"	2-1/8"
2-1/2"	2-5/8"
3"	3-1/8"
4"	4-1/8"

CF

JONES STEPHENS TOILET SEATS

Wood Seats 381-383
Plastic Seats 384-388
Soft Seats 389
Acrylic Seats..... 390
Replacement Hardware 390

TS

*Published March 2017. List prices can be found in list price book and on our website.

Premium Molded Wood

- Durable molded wood
- Stainless steel pintel on C023 and C024 seats
- Adjustable
- QuicKlean® adjustable hinges on specified models
- EZ Close® feature on specified models
- Multi-coat high gloss enamel paint
- Beveled lid
- Four color-matched bumpers
- Color-matched hinges
- Stainless steel screws
- Non-skid rubberized pads
- Corrosion resistant mounting hardware

IDEAL FOR:

- Manufactured Housing
- Residential
- Apartments
- Condos



NOTE: Existing standard hinges will change to QuicKlean® upon depletion of existing inventory.

With Color-Matched QuicKlean® Hinges - Closed Front with Cover

ROUND	ELONGATED	SEAT / HINGE COLOR
C023WD00	C024WD00	White / White
C023WD01	C024WD01	Bone / Bone
C023WD02	C024WD02	Biscuit / Biscuit
C023WD04	C024WD04	Cotton White / Cotton White

See inside back cover for available seat and hinge color swatches.



NOTE: Existing standard hinges will change to QuicKlean® upon depletion of existing inventory.

Anti-Microbial with Metal Finish QuicKlean® Hinges - Closed Front with Cover

ROUND	ELONGATED	SEAT / HINGE COLOR
C3B4R300AMBN	C3B4E300AMBN	White / Brushed Nickel Finish
C3B4R300AMAB	—	White / Antique Brass Finish

See inside back cover for available seat and hinge color swatches.



For Vortens®* Toilets - Closed Front with Cover

ROUND	ELONGATED	SEAT / HINGE COLOR
—	U300V00	White / White

See inside back cover for available seat and hinge color swatches.

** The manufacturer's names are used only to describe which toilets the seats will fit. The seats are not manufactured by those companies.*

Deluxe Molded Wood

- Durable molded wood
- Adjustable
- EZ Close® feature on specified models
- Multi-coat high gloss enamel paint
- Beveled lid
- Four color-matched bumpers
- Color-matched hinges
- Stainless steel screws
- Non-skid rubberized pads
- Corrosion resistant mounting hardware

IDEAL FOR:

- Manufactured Housing
- Offices
- Residential
- Apartments
- Condos
- Restaurants
- Dormitories



With Plastic Color-Matched Hinges - Closed Front with Cover

ROUND	ELONGATED	SEAT / HINGE COLOR
C013WD00	C014WD00	White / White
C013WD01	C014WD01	Bone / Bone
C013WD02	C014WD02	Biscuit / Biscuit
C013WD03	C014WD03	Almond / Almond
C013WD04	C014WD04	Cotton White / Cotton White
C3B4R220	C014WD20	Venetian Pink / Venetian Pink
C3B4R230	C014WD30	Fawn Beige / Fawn Beige
C3B4R240	C014WD40	Dresden Blue / Dresden Blue
C3B4R245	C014WD45	Regency Blue / Regency Blue
C3B4R250	C014WD50	Citron Yellow / Citron Yellow
C3B4R253	C014WD53	Harvest Gold / Harvest Gold
C3B4R258	C014WD58	Avocado / Avocado
C3B4R280	C014WD80	Silver / Silver
C3B4R290	C014WD90	Black / Black

See inside back cover for available seat and hinge color swatches.

Items marked with the Jones Stephens logo are "You Need It...We Got It" Items.

Deluxe Molded Wood (cont.)

- Durable molded wood
- Adjustable
- EZ Close® feature on specified models
- Multi-coat high gloss enamel paint
- Beveled lid
- Four color-matched bumpers
- Color-matched hinges
- Stainless steel screws
- Non-skid rubberized pads
- Corrosion resistant mounting hardware

IDEAL FOR:

- Manufactured Housing
- Offices
- Residential
- Apartments
- Condos
- Restaurants
- Dormitories



Hinge Color Matched to Seat

With International Hinges - Closed Front with Cover

ROUND	ELONGATED	SEAT / HINGE COLOR
C013WD00INT	—	White / White

See inside back cover for available seat and hinge color swatches.



Decorative Metal Hinges

Anti-Microbial with Decorative Metal Hinges - Closed Front with Cover

ROUND	ELONGATED	SEAT / HINGE COLOR
C013WD00CH	C014WD00CH	White / Chrome
—	C014WD00BN	White / Brushed Nickel
C3B4R201BN	—	Bone / Brushed Nickel
C3B4R290CH	C3B4E290CH	Black / Chrome

See inside back cover for available seat and hinge color swatches.



Hinge Color Matched to Seat



EZ Close®

EZ Close® with Plastic Color-Matched Hinges - Closed Front with Cover

ROUND	ELONGATED	SEAT / HINGE COLOR
C013WDS00	C014WDS00	White / White

See inside back cover for available seat and hinge color swatches.

TS

Deluxe Molded Wood (cont.)



Hinge Color Matched to Seat

With Plastic Color-Matched Hinges - Open Front with Cover

ROUND	ELONGATED	SEAT / HINGE COLOR
C013WDO00	C014WDO00	White / White

See inside back cover for available seat and hinge color swatches.



Decorative Metal Hinges

Sculpted with Decorative Metal Hinges - Closed Front with Cover

ROUND	ELONGATED	SEAT / HINGE COLOR
C3B4R400CH	—	White Bead Board / Chrome

See inside back cover for available seat and hinge color swatches.



Hinge Color Matched to Seat

Square Front for Eljer®* New Emblem™ Toilets with Plastic Color-Matched Hinges - Closed Square Front with Cover

ROUND	ELONGATED	SEAT / HINGE COLOR
C049WD00	C050WD00	White / White

See inside back cover for available seat and hinge color swatches.

Standard Molded Wood

- Durable molded wood
- Multi-coat high gloss enamel paint
- Color-matched hinges and bumpers
- Stainless steel screws
- Corrosion resistant mounting hardware

IDEAL FOR:

- Manufactured Housing
- Residential
- Apartments
- Condos



Hinge Color Matched to Seat

With Plastic Color-Matched Hinges - Closed Front with Cover

ROUND	ELONGATED	SEAT / HINGE COLOR
C001WD00	C002WD00	White / White
C001WD01	C002WD01	Bone / Bone

See inside back cover for available seat and hinge color swatches.

Utility Molded Wood

- Durable molded wood
- Adjustable
- Multi-coat high gloss enamel paint
- Color-matched hinges and bumpers
- Stainless steel screws
- Non-skid rubberized pads
- Corrosion resistant mounting hardware

IDEAL FOR:

- Manufactured Housing
- Residential
- Apartments
- Condos



With Plastic Color-Matched Hinges - Closed Front with Cover

ROUND	ELONGATED	SEAT / HINGE COLOR
U003WD00	U004WD00	White / White

See inside back cover for available seat and hinge color swatches.

Decorative Piano Finish, Solid Bamboo

- Sealed with 1 mil of high gloss polyurethane
- Four color-matched bumpers
- Corrosion resistant mounting hardware

IDEAL FOR:

- Manufactured Housing
- Residential
- Apartments
- Condos



With Decorative Metal Hinges - Closed Front with Cover

ROUND	ELONGATED	SEAT / HINGE COLOR
C3B2R220BN	C3B2E220BN	Natural Bamboo / Brushed Nickel

See inside back cover for available seat and hinge color swatches.

Decorative Piano Finish, Solid Oak

- Solid oak construction
- Sealed with 1 mil of high gloss polyurethane
- PVD hinge
- Four color-matched bumpers
- Corrosion resistant mounting hardware

IDEAL FOR:

- Manufactured Housing
- Residential
- Apartments
- Condos



Anti-Microbial with Decorative Metal Hinges - Closed Front with Cover

ROUND	ELONGATED	SEAT / HINGE COLOR
C2B1R16CH	C2B1E16CH	Mahogany Finish / Chrome
C2B1R16BR	C2B1E16BR	Mahogany Finish / Brass
C2B1R16BN	C2B1E16BN	Mahogany Finish / Brushed Nickel
C2B1R17CH	C2B1E17CH	Natural Oak / Chrome
C2B1R17BR	C2B1E17BR	Natural Oak / Brass
C2B1R17BN	C2B1E17BN	Natural Oak / Brushed Nickel
C2B1R18CH	C2B1E18CH	Dark Brown Finish / Chrome
C2B1R18BN	C2B1E18BN	Dark Brown Finish / Brushed Nickel
C2B1R19CH	C2B1E19CH	Walnut Finish / Chrome
C2B1R19BN	C2B1E19BN	Walnut Finish / Brushed Nickel

See inside back cover for available seat and hinge color swatches.

Decorative Natural Finish, Solid Oak

- EZ Close® feature on specified models
- Sealed with polyurethane
- Four color-matched bumpers
- Corrosion resistant mounting hardware

IDEAL FOR:

- Manufactured Housing
- Residential
- Apartments
- Condos



With Decorative Metal Hinges - Closed Front with Cover

ROUND	ELONGATED	SEAT / HINGE COLOR
C3B2R117CH	—	Light Oak Finish / Chrome
C3B2R117BR	C3B2E117BR	Light Oak Finish / Brass
C3B2R117BN	C3B2E117BN	Light Oak Finish / Brushed Nickel
C3B2R118CH	C3B2E118CH	Dark Brown Finish / Chrome
C3B2R118BN	C3B2E118BN	Dark Brown Finish / Brushed Nickel
—	C3B2E115BN	Cherry Finish / Brushed Nickel

See inside back cover for available seat and hinge color swatches.



EZ Close® with Decorative Metal Hinges - Closed Front with Cover

ROUND	ELONGATED	SEAT / HINGE COLOR
C2B1RS19CH	C2B1ES19CH	Natural Black Walnut / Chrome

See inside back cover for available seat and hinge color swatches.

Premium Residential Plastic

- Injection molded durable polypropylene plastic with UV protection
- QuickKlean® adjustable hinges on specified models
- EZ Close® feature on specified models
- Beveled lid
- Four molded-in color-matched bumpers
- Color-matched hinges
- Non-skid rubberized pads
- Corrosion resistant mounting hardware

IDEAL FOR:

- Manufactured Housing
- Residential
- Apartments
- Condos
- Schools
- Offices
- Hotels
- Restaurants
- Dormitories



NOTE: Existing standard hinges will change to QuickKlean® upon depletion of existing inventory.

EZ Close® with Color-Matched QuickKlean® Hinges - Closed Front with Cover

ROUND	ELONGATED	SEAT / HINGE COLOR
C1606S00	C2200S00	White / White
C1606S01	C2200S01	Bone / Bone
C1606S02	C2200S02	Biscuit / Biscuit
C1606S03	C2200S03	Almond / Almond
C1606S04	C2200S04	Cotton White / Cotton White
C1606S30	C2200S30	Fawn Beige / Fawn Beige
C1606S40	C2200S40	Dresden Blue / Dresden Blue
C1606S45	C2200S45	Regency Blue / Regency Blue
C1606S58	C2200S58	Avocado / Avocado
C1606S90	C2200S90	Black / Black

See inside back cover for available seat and hinge color swatches.



NOTE: Existing standard hinges will change to QuickKlean® upon depletion of existing inventory.

With Color-Matched QuickKlean® Hinges - Closed Front with Cover

ROUND	ELONGATED	SEAT / HINGE COLOR
C160600	C220000	White / White

See inside back cover for available seat and hinge color swatches.



NOTE: Existing standard hinges will change to QuickKlean® upon depletion of existing inventory.

EZ Close® with Color-Matched QuickKlean® Hinges - Closed Front with Cover

ROUND	ELONGATED	SEAT / HINGE COLOR
C3B3RSL00	C3B3ESL00	White / White

6 Pack EZ Close® w/Color-Matched QuickKlean® Hinges - Closed Front w/Cover

ROUND	ELONGATED	SEAT / HINGE COLOR
C3B3RSL00	C3B3ESL00	White / White

See inside back cover for available seat and hinge color swatches.

Deluxe Residential Plastic

- Injection molded durable polypropylene plastic with UV protection
- QuickKlean® adjustable hinges on specified models
- EZ Close® feature on specified models
- Adjustable
- Four molded-in bumpers
- Color-matched hinges and bumpers
- Non-skid rubberized pads
- Corrosion resistant mounting hardware

IDEAL FOR:

- Manufactured Housing
- Residential
- Apartments
- Condos
- Offices
- Portable Toilets



With Color-Matched Hinges - Closed Front with Cover

ROUND	ELONGATED	SEAT / HINGE COLOR
C104100	C104200	White / White
C104101	C104201	Bone / Bone
C104102	C104202	Biscuit / Biscuit

See inside back cover for available seat and hinge color swatches.



NOTE: Existing standard hinges will change to QuickKlean® upon depletion of existing inventory.

EZ Close® with Color-Matched QuickKlean® Hinges - Closed Front with Cover

ROUND	ELONGATED	SEAT / HINGE COLOR
C1210S00	C1211S00	White / White
C1210S01	C1211S01	Bone / Bone
C1210S02	C1211S02	Biscuit / Biscuit

See inside back cover for available seat and hinge color swatches.



With Color-Matched Hinges - Open Front with Cover

ROUND	ELONGATED	SEAT / HINGE COLOR
—	C1042000	White / White

See inside back cover for available seat and hinge color swatches.

TS

Items marked with the Jones Stephens logo are "You Need It... We Got It" Items.

Deluxe Residential Plastic (cont.)



Euro Design with Color-Matched Hinges and Telescoping Cover to Conceal Entire Ring - Closed Front with Cover

ROUND	ELONGATED	SEAT / HINGE COLOR
C3B3R200	C3B3E200	White / White

See inside back cover for available seat and hinge color swatches.



Square Front for Eljer®* New Emblem™ Toilets with Color-Matched Hinges - Closed Square Front with Cover

ROUND	ELONGATED	SEAT / HINGE COLOR
—	C105000	White / White

See inside back cover for available seat and hinge color swatches.



EZ Close® Square Front for Eljer®* New Emblem™ Toilets with Color-Matched Hinges - Closed Square Front with Cover

ROUND	ELONGATED	SEAT / HINGE COLOR
—	C1050S00	White / White
—	C1050S01	Bone / Bone

See inside back cover for available seat and hinge color swatches.

Standard Residential Plastic

- Injection molded durable polypropylene plastic with UV protection
- QuickKlean® adjustable hinges on specified models
- EZ Close® feature on specified models
- Adjustable
- Four molded-in color-matched bumpers
- Color-matched hinges
- Non-skid rubberized pads
- Corrosion resistant mounting hardware

IDEAL FOR:

- Manufactured Housing
- Residential
- Apartments
- Condos
- Schools
- Offices
- Hotels
- Restaurants
- Dormitories
- Portable Toilets



With Color-Matched Hinges - Closed Front with Cover

ROUND	ELONGATED	SEAT / HINGE COLOR
C803200	C803300	White / White
C803201	C803301	Bone / Bone

See inside back cover for available seat and hinge color swatches.



EZ Close® with Color-Matched Hinges - Closed Front with Cover

ROUND	ELONGATED	SEAT / HINGE COLOR
C1106S00	C1107S00	White / White

See inside back cover for available seat and hinge color swatches.

Adult/Juvenile Residential Plastic

- Injection molded durable polypropylene plastic with UV protection
- EZ Close®
- Adjustable
- Four molded-in color-matched bumpers
- Color-matched hinges
- Non-skid rubberized pads
- Corrosion resistant mounting hardware
- Extra thick support ring for increased strength

- Adult/juvenile seat design for children and adults eliminates the need to install and remove training seat
- Juvenile seat held in place with magnet

IDEAL FOR:

- Manufactured Housing
- Residential
- Apartments
- Condos
- Schools



EZ Close® with Color-Matched Hinges - Closed Front with Cover

ROUND	ELONGATED	SEAT / HINGE COLOR
C3B3RJS00	C3B3EJS00	White / White

See inside back cover for available seat and hinge color swatches.

Builder Grade Residential Plastic

- Injection molded durable polypropylene plastic with UV protection
- Adjustable
- Four molded-in color-matched bumpers
- Color-matched hinges
- Non-skid rubberized pads
- Corrosion resistant mounting hardware
- Truck packs available on specified models (Box of 10 individually shrink wrapped seats separated by cardboard slats)

IDEAL FOR:

- Manufactured Housing
- Residential
- Apartments
- Condos
- Offices
- Portable Toilets



With Color-Matched Hinges - Closed Front with Cover

ROUND	ELONGATED	SEAT / HINGE COLOR
C101000	C101100	White / White
C101001	C101101	Bone / Bone
C101002	C101102	Biscuit / Biscuit

Truck Pack

ROUND	ELONGATED	SEAT / HINGE COLOR
C1010TK00	C1011TK00	White / White

See inside back cover for available seat and hinge color swatches.

Utility Grade Residential Plastic

- Injection molded durable polypropylene plastic with UV protection
- Adjustable
- Four molded-in color-matched bumpers
- Color-matched hinges
- Corrosion resistant mounting hardware
- Truck packs available on specified models (Box of 10 individually shrink wrapped seats separated by cardboard slats)

IDEAL FOR:

- Manufactured Housing
- Apartments
- Condos
- Portable Toilets



With Color-Matched Hinges - Closed Front with Cover

ROUND	ELONGATED	SEAT / HINGE COLOR
U100500	U100600	White / White
U100700	U100800	White / White

Truck Pack

ROUND	ELONGATED	SEAT / HINGE COLOR
—	U1008TK00	White / White

See inside back cover for available seat and hinge color swatches.

Extra Heavy Duty Commercial Plastic

- Injection molded durable polypropylene plastic with UV protection
- Anti-microbial on specified models
- External color-matched check hinge
- Four molded-in color-matched bumpers
- Extra heavy duty weight and posture curve design
- Ergonomic design
- 304 grade stainless steel hinge post and hardware
- Anti-skid rubberized bushings
- Concealed hinges

IDEAL FOR:

- Service Stations
- Public Restrooms
- Hospitals
- Hotels
- Assisted Living
- Offices
- Correctional Institutes
- Park Facilities
- Schools
- Stadiums
- Airports



With Color-Matched Check Hinge - Open Front less Cover

ROUND	ELONGATED	SEAT / HINGE COLOR
—	C110C00	White / White

See inside back cover for available seat and hinge color swatches.

Heavy Duty Commercial Plastic

- Injection molded durable polypropylene plastic with UV protection
- Anti-microbial on specified models
- External color-matched check hinge
- Four molded-in color-matched bumpers
- Heavy duty weight
- 304 grade stainless steel hinge post and hardware
- Anti-skid rubberized bushings
- Concealed hinges
- Self-sustaining feature available on specified models

IDEAL FOR:

- Service Stations
- Public Restrooms
- Hospitals
- Hotels
- Assisted Living
- Offices
- Correctional Institutes
- Park Facilities
- Schools
- Stadiums
- Airports



With Color-Matched Check Hinge - Open Front less Cover

ROUND	ELONGATED	SEAT / HINGE COLOR
—	C108C00	White / White

With Color-Matched Self-Sustaining Check Hinge - Open Front less Cover

ROUND	ELONGATED	SEAT / HINGE COLOR
—	C108SSC00	White / White

Anti-Microbial with Color-Matched Self-Sustaining Check Hinge - Open Front less Cover

ROUND	ELONGATED	SEAT / HINGE COLOR
—	C108SSCAM00	White / White

See inside back cover for available seat and hinge color swatches.

TS

Items marked with the Jones Stephens logo are "You Need It...We Got It" Items.

Deluxe Heavy Duty Commercial Plastic

- Injection molded durable polypropylene plastic with UV protection
- QuicKlean® adjustable hinges
- EZ Close® feature on specified models
- Adjustable
- Four molded-in color-matched bumpers
- Color-matched hinges
- Corrosion resistant mounting hardware
- Stainless steel pintels
- Anti-skid rubberized pads
- Stainless steel posts

IDEAL FOR:

- Public Restrooms
- Offices
- Airports
- Manufactured Housing
- Portable Toilets
- Residential
- Condos
- Apartments



NOTE: Existing standard hinges will change to QuicKlean® upon depletion of existing inventory.

EZ Close® with Color-Matched Hinges - Closed Front with Cover

ROUND	ELONGATED	SEAT / HINGE COLOR
—	C8019S00	White / White

See inside back cover for available seat and hinge color swatches.

Deluxe Commercial Plastic

- Injection molded durable polypropylene plastic with UV protection
- External color-matched check hinge
- Four molded-in color-matched bumpers
- 304 grade stainless steel hinge post and hardware
- Anti-skid rubberized bushings
- Concealed hinges
- Self-sustaining
- Fire retardant on specified models
- Anti-microbial on specified models

IDEAL FOR:

- Service Stations
- Public Restrooms
- Hospitals
- Hotels
- Assisted Living
- Offices
- Correctional Institutes
- Park Facilities
- Schools
- Stadiums
- Airports



With Color-Matched Check Hinge - Open Front less Cover

ROUND	ELONGATED	SEAT / HINGE COLOR
C105C00	C106C00	White / White
—	C106C90	Black / Black

With Color-Matched Self-Sustaining Check Hinge - Open Front less Cover

ROUND	ELONGATED	SEAT / HINGE COLOR
C105SSC00	C106SSC00	White / White
—	C106SSC01	Bone / Bone
C105SSC90	C106SSC90	Black / Black

Anti-Microbial with Color-Matched Self-Sustaining Check Hinge - Open Front less Cover

ROUND	ELONGATED	SEAT / HINGE COLOR
—	C106SSCAM00	White / White
—	C106SSCAM90	Black / Black

Anti-Microbial and Fire Retardant with Color-Matched Self-Sustaining Check Hinge - Open Front less Cover

ROUND	ELONGATED	SEAT / HINGE COLOR
—	C106SSCAMFR0	White / White

See inside back cover for available seat and hinge color swatches.

Got To Have It!

Deluxe Commercial Plastic EZ Close® with Chrome Plated Check Hinge - Open Front less Cover

- Injection molded durable polypropylene plastic with UV protection
- Four molded-in color-matched bumpers
- 304 grade stainless steel hinge post and hardware
- Anti-skid rubberized bushings
- Concealed hinges
- Self-sustaining check hinge



TS

ROUND	ELONGATED	SEAT / HINGE COLOR
—	C106CEZ00	White / Chrome

See inside back cover for available seat and hinge color swatches.

Items marked with the Jones Stephens logo are "You Need It...We Got It" Items.

Standard Commercial Plastic

- Injection molded durable polypropylene plastic with UV protection
- External color-matched check hinge
- Four molded-in color-matched bumpers
- Anti-skid rubberized bushings
- Concealed hinges

IDEAL FOR:

- Portable Toilets
- Hospitals
- Assisted Living



With Color-Matched Check Hinge, Plastic and Stainless Steel Hardware - Open Front less Cover

ROUND	ELONGATED	SEAT / HINGE COLOR
—	C106CHPM00	White / White

See inside back cover for available seat and hinge color swatches.

Premium Commercial/Institutional Plastic

- Injection molded durable polypropylene plastic with UV protection
- EZ Close® feature on specified models
- Adjustable
- Four molded-in color-matched bumpers
- Color-matched hinges
- Corrosion resistant mounting hardware
- Anti-skid rubberized pads
- Fire retardant on specified models
- Stainless steel posts
- Anti-microbial on specified models

IDEAL FOR:

- Public Schools
- Schools
- Public Family Restrooms



With Color-Matched Hinges - Open Front with Cover

ROUND	ELONGATED	SEAT / HINGE COLOR
—	C2200O00	White / White

With Color-Matched Hinges and Stainless Steel Hinge Posts - Closed Front with Cover

ROUND	ELONGATED	SEAT / HINGE COLOR
C1606HPSS00	C2200HPSS00	White / White
—	C2200HPSS90	Black / Black

Anti-Microbial and Fire Retardant with Color-Matched Hinges and Stainless Steel Hinge Posts - Closed Front with Cover

ROUND	ELONGATED	SEAT / HINGE COLOR
—	C2200HPSSAMF	White / White

See inside back cover for available seat and hinge color swatches.

Commercial Baby Bowl Plastic

- Injection molded durable polypropylene plastic with UV protection
- External color-matched check hinge
- Four molded-in color-matched bumpers
- 304 grade stainless steel hinge post and hardware
- Anti-skid rubberized bushings
- Concealed hinges
- Self-sustaining
- Anti-microbial



Anti-Microbial with Color-Matched Self-Sustaining Check Hinge - Open Front less Cover

ROUND	ELONGATED	SEAT / HINGE COLOR
C100BBSSCAM0	—	White / White

See inside back cover for available seat and hinge color swatches.

TS

Premium Commercial/Institutional Plastic (cont.)



Hinge Color Matched to Seat



EZ Close®

EZ Close® with Color-Matched Hinges - Open Front with Cover

ROUND	ELONGATED	SEAT / HINGE COLOR
C1606OS00	C2200OS00	White / White

EZ Close® Anti-Microbial with Color-Matched Hinges and Stainless Steel Hinge Posts - Open Front with Cover

ROUND	ELONGATED	SEAT / HINGE COLOR
—	C2200OS00HPSSAM	White / White

See inside back cover for available seat and hinge color swatches.

Premium Heavy Duty Commercial Plastic

- Injection molded durable polypropylene plastic with UV protection
- EZ Close® feature on specified models
- QuicKlean® adjustable hinges on specified models
- Adjustable
- Four molded-in color-matched bumpers
- Color-matched hinges
- Corrosion resistant mounting hardware
- Stainless steel pintels
- Anti-skid rubberized pads
- Stainless steel posts

IDEAL FOR:

- Public Restrooms
- Offices
- Airports
- Manufactured Housing
- Portable Toilets
- Residential
- Condos
- Apartments



Hinge Color Matched to Seat

With Color-Matched Hinges - Closed Front with Cover

ROUND	ELONGATED	SEAT / HINGE COLOR
C801800	—	White / White

See inside back cover for available seat and hinge color swatches.

Light Duty Commercial Plastic

- Injection molded durable polypropylene plastic with UV protection
- Adjustable
- Four molded-in color-matched bumpers
- Color-matched hinges
- Corrosion resistant mounting hardware
- Extra large pintels
- Anti-skid rubberized pads

IDEAL FOR:

- Public Restrooms
- Portable Toilets
- Hotels
- Offices
- Schools
- Airports
- Restaurants
- Dormitories



Hinge Color Matched to Seat

With Color-Matched Hinges - Open Front with Cover

ROUND	ELONGATED	SEAT / HINGE COLOR
C8032000	C8033000	White / White



Hinge Color Matched to Seat

Contemporary Style with Color-Matched Hinges - Open Front with Cover

ROUND	ELONGATED	SEAT / HINGE COLOR
—	C102C00	White / White

See inside back cover for available seat and hinge color swatches.

Specialty Plastic

- ADA compliant with 2" lift
- Fits round or elongated bowls
- Durable plastic construction
- Designed for use in hospitals or public restrooms

IDEAL FOR:

- Hospitals
- Assisted Living
- Airports



Stainless Steel Hinge

Big John - Closed Front with Cover

ROUND	ELONGATED	SEAT / HINGE COLOR
24456461W	24456461W	White / Stainless Steel

Big John - Open Front with Cover

ROUND	ELONGATED	SEAT / HINGE COLOR
24452633W	24452633W	White / Stainless Steel

Big John - Closed Front less Cover

ROUND	ELONGATED	SEAT / HINGE COLOR
24452634W	24452634W	White / Stainless Steel

See inside back cover for available seat and hinge color swatches.

Specialty Plastic (cont.)



Big John Wall Hung Support - 1000 pounds

ROUND	ELONGATED	COLOR
—	612011919	White with Gray Trim

Standard and Deluxe Soft Seats

- Standard is constructed using high density vinyl
- Deluxe is constructed using heavy duty embossed vinyl
- UV paint color protection
- QuickClean® adjustable hinges on specified models
- Color-matched hinges
- Four color-matched bumpers
- Adjustable
- Non-skid rubberized pads
- Corrosion resistant mounting hardware

IDEAL FOR:

- Manufactured Housing
- Apartments
- Condos
- Residential



Hinge Color Matched to Seat



QuickClean®

NOTE: Existing standard hinges will change to QuickClean® upon depletion of existing inventory.

Deluxe Anti-Microbial with Solid Wood Core and Color-Matched QuickClean® Hinges - Closed Front with Cover

ROUND	ELONGATED	SEAT / HINGE COLOR
C3B5R200	C3B5E200	White / White
C3B5R201	C3B5E201	Bone / Bone
C3B5R221	—	Pink / Pink
C3B5R242	—	Blue / Blue
C3B5R260	—	Forest Green / Forest Green
C3B5R270	—	Claret / Claret
C3B5R200	C3B5E200	White / White

See inside back cover for available seat and hinge color swatches.



Decorative Metal Hinges

TS Deluxe Anti-Microbial with Solid Wood Core and Decorative Metal Hinge - Closed Front with Cover

ROUND	ELONGATED	SEAT / HINGE COLOR
C3B5R200CH	C3B5E200CH	White / Chrome

See inside back cover for available seat and hinge color swatches.

Designer Acrylic

- Clear acrylic
- Life-like embedded objects
- Corrosion resistant mounting hardware
- Four clear bumpers

IDEAL FOR:

- Manufactured Housing
- Apartments
- Condos
- Residential



Decorative Metal Hinges

Aquarium with Decorative Metal Hinges - Closed Front with Cover

ROUND	ELONGATED	SEAT / HINGE COLOR
C2B6R9AQCH	—	Aquarium / Chrome

See inside back cover for available seat and hinge color swatches.



Decorative Metal Hinges

Seahorse with Decorative Metal Hinges - Closed Front with Cover

ROUND	ELONGATED	SEAT / HINGE COLOR
C2B6R9SHCH	—	Seahorse / Chrome

See inside back cover for available seat and hinge color swatches.

Replacement Hardware



C200HPSS



C200HEX

Hinge Post Hardware

PART NO.	DESCRIPTION	MATERIAL
C200HPSS	For all top mounts except C001WD, C002WD, C1005	Stainless Steel
C200HEX	Hinge post hardware for all top mounts except C001WD, C002WD, C1005	White Plastic



C306CHPSS00



C406CHPSS00

Hinge Post Hardware

PART NO.	DESCRIPTION	MATERIAL
C306CHPSS00	Hinge pack for check hinge toilet seat (white only)	304 Stainless
C406SSCHPSS00	Hinge pack for self-sustaining check hinge toilet seat (white only)	304 Stainless

CONTRACTOR SPECIALTIES AND MRO PRODUCTS

Plumbing	395
Cleaning	395-397
Safety	397-400
Outdoor	400-401
Contractor Tools	401-405
Electrical	405-407
Security	408

MRO

*Published March 2017. List prices can be found in list price book and on our website.

IT TAKES MORE THAN PLUMBING SUPPLIES TO FINISH A PLUMBING PROJECT.

A day on the job requires specialty items—along with gloves, trash bags, work lights, and more.

Order contractor specialty items and MRO products for:

- PLUMBING
- CLEANING
- SAFETY
- OUTDOOR
- TOOLS
- ELECTRICAL
- SECURITY



At Jones Stephens, we know plumbers. That's why these pages carry more than the widest possible range of plumbing supplies. They include the products your customers typically need on the jobsite, everyday items such as work lights.... and gloves, and trash bags, and extension cords, and locksets, and caulk, and so much more.

So as you're picking the plumbing supplies your customers are looking for—be sure to order the items they need to finish the job. They'll thank you. And you'll thank us.

Integral Float Fill Valve



- Fits most toilets
- Replace all of the complicated mechanisms with this simple kit
- Adjustable height from 9" to 13"
- Adjustable float for adjustable water height
- Similar to Fluidmaster®* 400A

PART NO.	DESCRIPTION	CTN/MSTR
T02070	Integral float fill valve	1/12

* The manufacturers' names are used only to describe whose products the products will fit.

Hollow Wall Anchor Kit



- 100 pieces
- 4 sizes and styles
- Anchors, screws and toggle bolts
- Reclosable, reusable, divided plastic container

PART NO.	DESCRIPTION	CTN/MSTR
A33006	100 piece hollow wall anchor kit	12/72

The Green Drain Waterless Trap Seal



- Requires NO caulk or expensive installation tool
- Easy to install and easy to remove - NO pliers needed
- Durable - will not break during installation or removal
- Seals tight - NO leaking

PART NO.	DESCRIPTION	CTN/MSTR
P24001	2" waterless trap seal	1/96
P24002	3" waterless trap seal	1/96
P24003	3-1/2" waterless trap seal	1/96
P24004	4" waterless trap seal	1/96

Force Cup Plunger



- Highest quality rubber
- Supplied with handle

PART NO.	DESCRIPTION	CTN/MSTR
D18001	5 1/2" diameter (red rubber)	1/48
D18002	6" professional style (black rubber)	1/24

Professional Force Cup Display



Cloghopper Display

- Highest quality rubber
- Supplied with handle
- Attractive point of purchase display
- Display box contains 30 rubber plungers
- CARTON QUANTITIES ONLY

PART NO.	DESCRIPTION	CTN/MSTR
D18000	Rubber plungers and display box	1/1

Items marked with the Jones Stephens logo are "You Need It... We Got It" Items.

Toilet Plunger

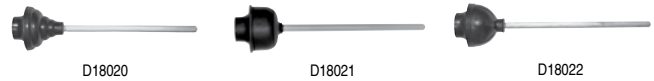

- Professional quality
- Yellow hardwood handles with black tailpiece

PART NO.	DESCRIPTION	CTN/MSTR
D18020	Thronemaster® professional stepped plunger	1/4
D18021	Professional plumber's plunger	1/12
D18022	HYDRO-TRUST heavy duty deluxe plunger	1/24

Medium Floor Sweep, Black



- Long-lasting multi-surface polypropylene and natural tampico bristles are ideal for light to medium debris on both smooth and rough floor surfaces
- Accepts threaded handle on either side for even wear
- Optional angle brace adds support and stability
- Handle sold separately (G80027)

PART NO.	DESCRIPTION	CTN/MSTR
G80024	24" medium sweep push broom, less handle	1/12
G80027	5 ft. wood handle with threaded metal tip (15/16" thick)	1/12

Angle Broom with 1" Diameter Handle



- Cut and shaped for easy sweeping
- Long-lasting, stain-resistant polypropylene bristles
- Permanent fusion-set bristles won't pull out

PART NO.	DESCRIPTION	CTN/MSTR
G80023	Angle broom with 1" diameter handle	1/6

Angle Broom



- Vinyl coated metal handle

PART NO.	DESCRIPTION	CTN/MSTR
B29850	Large plastic angle broom	1/12
B29851	Small plastic angle broom	1/24

Executive Lobby Pro® Upright Dust Pan



- Durable rear wheels improve wear resistance and extend product life

PART NO.	DESCRIPTION	CTN/MSTR
G80025	Upright dust pan	1/6

WaveBrake® 35 Quart Side-Press Mop Bucket



- Tested to exceed 40,000 wringing cycles
- Premium tubular steel and structural web molded plastic
- WaveBrake® buckets work with Rubbermaid High-Capacity and Rubbermaid HYGEN™ Cleaning Carts
- Accepts optional dirty water bucket



PART NO.	DESCRIPTION	CTN/MSTR
G80020	35 quart side-press mop bucket	1/1

Cotton Terry Cloth Towels



- 100% cotton
- 14" x 17"
- Waxes, dries and polishes
- Super soft

PART NO.	DESCRIPTION	CTN/MSTR
B05025	Terry cloth towels, 3 pack	1/10
B05026	Terry cloth towels, 8 pack	1/12

Trash Bags



- 2'8" x 4'2"
- 20 bags per box
- 42 gallon
- 3 mil

PART NO.	DESCRIPTION	CTN/MSTR
G02042	42 gallon trash bags	1/6

Drum Liners



- 37.5" x 48" x 10"
- 20 bags per box
- 55 gallon
- 2 mil

PART NO.	DESCRIPTION	CTN/MSTR
G02050	55 gallon drum liners	1/6

Wypall® Teri® Towels



- Strong and durable, wet or dry
- 125 reusable sheets per box-equivalent to 18 lbs. of rags
- Reinforced HYDROKNIT® provides extra scrubbing power
- CASE QUANTITIES ONLY



PART NO.	DESCRIPTION	CTN/MSTR
B05003	9-3/4" x 16-3/4" x 125 sheets	1/10

Box of Rags



- Colored cotton sweatshirt material
- 100% recycled
- Pull out dispensing
- Multi-colored

PART NO.	DESCRIPTION	CTN/MSTR
B05001	4 lb. box of rags	1/1

Cotton Plumbers Handy Towels



- 100% cotton heavy duty shop towels are washable, reusable & nonabrasive
- Ideal for cleaning hands, wiping spills, removing grime from tools & parts
- 12 towels per bag

PART NO.	DESCRIPTION	CTN/MSTR
B05004	Plumbers handy towels	12/12

Plastic Drop Cloth



- Medium duty 1 mil plastic
- Convenient pleat fold pack design
- Protects furniture, appliances and carpets

PART NO.	DESCRIPTION	CTN/MSTR
D50000	9' x 12' plastic drop cloth	1/48

Cotton Canvas Drop Cloth



- 8 oz.
- Absorbs and traps spills
- Washable and reusable

PART NO.	DESCRIPTION	CTN/MSTR
G02010	6' x 9' cotton canvas drop cloth	1/6
G02011	9' x 12' cotton canvas drop cloth	1/4

Reinforced Plastic Blue Tarp



- Metal gromets
- Heavy duty plastic
- Blue color

PART NO.	DESCRIPTION	CTN/MSTR
B05100	10' x 12' plastic blue tarp	9/18
B05101	10' x 20' plastic blue tarp	1/8

Urinal Screen and Refills



- 4 oz. scented deodorant block
- Cherry scent
- S95251 is priced each and sold in CARTON QUANTITIES ONLY

PART NO.	DESCRIPTION	CTN/MSTR
S95250	Urinal screen	12/72
S95251	4 oz. cherry scent refills for urinal screen, 12 piece	12/72

Commercial Sponge



- Commercial grade cellulose sponges-made to last!
- Deeply textured top makes cleanup easier
- Made in the USA



DIMENSIONS	
S50001	6-3/4" x 4-3/8" x 3/4"
S50002	8" x 4-1/2" x 3/4"

PART NO.	DESCRIPTION	CTN/MSTR
S50001	Medium cellulose sponge	1/24
S50002	Large cellulose sponge	1/24

Spray Bottle



- Economical to use for leak testing when filled with soapy water
- Clear bottle with various color tints based on availability

PART NO.	DESCRIPTION	CTN/MSTR
B25001	16 oz. clear spray bottle	1/60

Heavy Duty Big Wipes



- 80 count tub, 8 tubs per case; priced each
- Wipe size is 8" x 12"
- Lint free
- Removes paint, glue, oil, sealants, grease and grime
- Dermatologically tested, plus vitamin E and aloe vera added
- Dual sided, scrubs and cleans
- CARTON QUANTITIES ONLY

PART NO.	DESCRIPTION	CTN/MSTR
B05050	80 count tub	8/8
B05051	Single pack - priced each (bag of 100)	1/100

Wypall® Waterless Hand Wipes



- 10 x 12 pre-moistened towels; 50 count
- Lower price per tub
- Conveniently sized tub
- All of the towels can be used before they dry out
- CARTON QUANTITIES ONLY

PART NO.	DESCRIPTION	CTN/MSTR
B05007	50-count dispenser tub	8/8
B05008	Wypall display (32 tubs)	1/1



- Full-sized pre-moistened hand towels- smooth for wiping on one side, tough for scrubbing on the other
- Natural d'limonene cleaning agent tough on grease, grime, ink & paint
- CASE QUANTITIES ONLY

PART NO.	DESCRIPTION	CTN/MSTR
B05002	12" x 12" x 75 sheets	6/6



- L40 Wipes in pop up box
- 9.8" x 16.4" sheets, 100 count white sheets
- For use with THE GRABBER Dispenser #09352

PART NO.	DESCRIPTION	CTN/MSTR
B05012	9.8" x 16.4" x 100 sheets	1/9

Disposable Vinyl Gloves



- One size fits all
- Rolled cuff
- Lightly powdered for easy on and off
- Ready to hang or place on shelf

PART NO.	DESCRIPTION	CTN/MSTR
G50251	20 pack disposable gloves	1/20



- One size fits all
- Non-powdered
- Non-sterile
- Heavy duty
- Multi-purpose
- Carded

PART NO.	DESCRIPTION	CTN/MSTR
G50302	8 pack disposable gloves	12/2

Blue Nitrile Gloves



- Powdered
- Priced per box
- 100 per box (50 pair)
- Thickness: 3 mil

PART NO.	DESCRIPTION	CTN/MSTR
G50230	Blue nitrile gloves - size large/XL	1/10
G50231	Blue nitrile gloves - size medium/large	1/10

Disposable Blue Latex Gloves



- 14 mil
- Priced per box
- 50 per box
- Powder free
- Examination grade
- Large

PART NO.	DESCRIPTION	CTN/MSTR
G50212	Disposable blue latex gloves	1/10

All Purpose Latex Palm/Mesh Back Gloves



- Durable
- Excellent in wet conditions
- Protects hands during rugged jobs
- CARTON QUANTITIES ONLY

PART NO.	DESCRIPTION	CTN/MSTR
G50202	Latex palm/mesh back gloves (carded)	12/240

Vinyl Gloves



- 5 mil.
- One size fits all
- Lightly powdered
- 100 reversible gloves (50 pair)

PART NO.	DESCRIPTION	CTN/MSTR
G50250	100 vinyl gloves	1/10

MRO

Industrial Rubber Gloves



- Extra heavy
- Large
- Pair
- Rolled cuffs
- CARTON QUANTITIES ONLY

PART NO.	DESCRIPTION	CTN/MSTR
G50223	14" smooth hands, 30 mil	12/72
G50220	18" rough hands, 25 mil	10/60

White Canvas Work Gloves



- Canvas
- Knit wrist
- Large/X-large
- CARTON QUANTITIES ONLY

PART NO.	DESCRIPTION	CTN/MSTR
G50228	White canvas (carded)	12/144

White Cotton Gloves with Grippers



- Durable 100% cotton canvas
- No-slip grip on palm
- One size fits all
- Knit wrist
- Priced per pair
- CARTON QUANTITIES ONLY

PART NO.	DESCRIPTION	CTN/MSTR
G50205	White cotton with rubber dots (bulk)	12/240
G50206	White cotton with rubber palms (bulk)	12/240
G50229	White cotton with PVC dots (carded)	12/144

Polyester Nitrile Dipped Palm Gloves



- 100% polyester
- Large/X-large
- Pair
- Knit wrist to keep out dirt

PART NO.	DESCRIPTION	CTN/MSTR
G50225	Polyester nitrile dipped palm (carded)	12/144

Nitrile Gloves



- 3/4 coating offers more protection
- Micro foam nitrile offers great grip
- Coating draws oil and water aside to allow for enhanced grip
- Good abrasion resistance
- Silicone free and antibacterial
- CARTON QUANTITIES ONLY

PART NO.	DESCRIPTION	CTN/MSTR
G50215	Pair nitrile	12/12

Leather Palm Work Gloves



- Split leather palm, thumb, fingers and knuckles
- 100% Cotton back and liner
- Safety cuff
- Priced per pair
- CARTON QUANTITIES ONLY

PART NO.	DESCRIPTION	CTN/MSTR
G50204	Leather palm low safety cuff (carded)	12/120

Items marked with the Jones Stephens logo are "You Need It... We Got It" Items.

Drivers' Style Leather Gloves



- Durable and long lasting - conforms to your hand with time
- Grain leather glove
- Elastic cuff
- Priced per pair
- CARTON QUANTITIES ONLY

PART NO.	DESCRIPTION	CTN/MSTR
G50208	Drivers' style leather (carded)	12/120

Economy Brown Jersey Gloves



- Made of cotton
- Large
- Close fitting knit wrist
- Comfortable
- Straight thumb
- Full size
- Priced per pair
- CARTON QUANTITIES ONLY

PART NO.	DESCRIPTION	CTN/MSTR
G50300	Economy brown cotton jersey (carded)	12/144

Brown Jersey Gloves



- 100% brown cotton
- One size fits all
- Knit wrist
- 8 ounce
- Priced per pair
- CARTON QUANTITIES ONLY

PART NO.	DESCRIPTION	CTN/MSTR
G50200	Brown cotton jersey (carded)	12/300

Carbon Monoxide Alarm



- Electrochemical CO sensor
- Loud 85 decibels
- Silence and test button
- Low battery indicator

PART NO.	DESCRIPTION	CTN/MSTR
L95500	Carbon monoxide alarm	1/6

Protective Shoe Covers



- Fits easily over work shoes and boots
- Elastic top allows fit up to size 12
- Keeps dirt and grime outside
- Carton holds 200 pieces (100 pair)
- SOLD BY FULL CARTON OR 10 PAIR PACK

PART NO.	DESCRIPTION	CTN/MSTR
B05010	Protective shoe covers (100 pair)	1/10
B05011	Protective shoe covers (10 pair)	1/15

Shubee Shoe Covers



- Dark blue
- Fits easily over work shoes and boots
- Elastic top allows fit up to size 12
- Keeps dirt and grime outside
- Carton holds 150 pair

PART NO.	DESCRIPTION	CTN/MSTR
B05015	Shubee shoe covers	1/1

MRO

Disposable Coverall



- Tear and puncture resistant
- Use when comfort and coolness is a priority
- CARTON QUANTITIES ONLY

PART NO.	DESCRIPTION	CTN/MSTR
B05020	Large disposable coverall	5/25
B05021	X-large disposable coverall	5/25

Dust Mask



- 50 per box
- Disposable
- Non-toxic

PART NO.	DESCRIPTION	CTN/MSTR
G30021	Dust mask	1/20

Orange Safety Vest



- Non-ANSI
- High visibility orange
- 100% polyester

PART NO.	DESCRIPTION	CTN/MSTR
B05090	Orange safety vest	1/20

Safety Hat



- Fits sizes 6 1/2- 8
- Meets ANSI z89.1 requirement
- Short peak design creates greater upward visibility
- Comfortable 4-point suspension with terry cloth sweatbands
- Low nape strap and rain trough features
- Universal slots to accommodate hearing, welding and face shield accessories

PART NO.	DESCRIPTION	CTN/MSTR
H40001	Yellow with 4-point pin lock suspension	1/12
H40002	White with 4-point pin lock suspension	1/12
H40003	Yellow with 4-point ratchet suspension	1/12
H40004	White with 4-point ratchet suspension	1/12

Knee Pads



K01120



K012000

- Lightweight and water-resistant
- Comfortable while kneeling, standing or walking
- Won't pinch or bind behind knee
- Soft, breathable inner lining for coolness and comfort
- Velcro closures on straps

PART NO.	DESCRIPTION	CTN/MSTR
K01120	Heavy duty foam economy	1/1
K012000	Heavy duty knee cap	1/1

Ready Fit Corded Ear Plugs



- Display box included
- CARTON QUANTITIES ONLY

PART NO.	DESCRIPTION	CTN/MSTR
E85000	Ready fit corded ear plugs	200 pair/1

Nemesis® Safety Glasses



Display



- Soft-touch temples
- Light weight construction
- Single-lens wrap-around protection
- 99.9% UV resistant
- Meets ANSI Z87.1 + standards

PART NO.	DESCRIPTION	CTN/MSTR
G30011	Nemesis® clear glasses	12/12
G30012	Nemesis® smoke mirror glasses	12/12
G30013	Nemesis® blue mirror glasses	12/12
G30014	Nemesis® camo/bronze glasses	12/12
G30000	Display includes: 12 pair smoke mirror, 6 pair blue mirror, 6 pair clear, free display	1/1
G30030	Dispenser box: 12 pair camo/bronze	1/1

Hellraiser Safety Glasses



Clear



Smoke



Blue Mirror

PART NO.	DESCRIPTION	CTN/MSTR
G30015	Hellraiser clear safety glasses	12/12
G30016	Hellraiser smoke safety glasses	12/12
G30017	Hellraiser blue mirror safety glasses	12/12

Visio Safety Glasses



- One-piece frame
- Adjustable temples
- Sleek, lightweight and comfortable
- Meets ANSI z87.1

PART NO.	DESCRIPTION	CTN/MSTR
G30003	Visio clear safety glasses	12/12
G30004	Visio blue mirror safety glasses	12/12
G30005	Visio silver indoor/outdoor glasses	12/12

Clear Safety Goggles



- Direct ventilation
- Economical protection

PART NO.	DESCRIPTION	CTN/MSTR
G30001	Clear safety goggles	1/200

MRO

Caution Tape



- Black print on safety yellow
- 3 mil thickness
- Non-stick

PART NO.	DESCRIPTION	CTN/MSTR
J43300	3" x 300' caution tape	1/16
J43310	3" x 1000' caution tape	1/8

Mobile Safety Barrier



- Easy to use, highly visible mobile barrier for use in many situations
- Flexible panels allow straight, curved, and circular configurations
- Extends to 13 feet when fully opened; locking straps keep barrier closed when not in use
- Lightweight and compact (2' x 13" footprint when closed)
- ANSI- and OSHA-compliant color
- For indoor use; shipped assembled

PART NO.	DESCRIPTION	CTN/MSTR
G80018	Mobile safety barrier	1/1

Wet Floor Caution Sign



- English/Spanish
- 25" height

PART NO.	DESCRIPTION	CTN/MSTR
G80030	Wet floor caution sign	1/6

Insulated Hose Nozzle



- Heavy duty with threaded end
- Soft comfort grip
- Carded

PART NO.	DESCRIPTION	CTN/MSTR
G04030	Insulated hose nozzle	12/72

4" Brass Hose Nozzle



- Twist to adjust spray
- Carded

PART NO.	DESCRIPTION	CTN/MSTR
G04031	4" brass hose nozzle	12/72

Contractor Grade Rubber Hose



- Contractor grade
- Reinforced rubber
- Heavy duty brass coupling

PART NO.	DESCRIPTION	CTN/MSTR
G04025	3/4" x 25' contractor grade rubber	1/4
G04026	3/4" x 50' contractor grade rubber	1/2

Commercial Premium Rubber Hose



PART NO.	DESCRIPTION	CTN/MSTR
G04005	5/8" x 25' commercial premium rubber	1/1
G04006	5/8" x 50' commercial premium rubber	1/1

Garden Hose



- G04001:
- 500 PSI burst strength
 - Kink-free construction
 - Heavy-duty solid brass nickel plated coupling
 - Built-in spring at faucet end to prevent hose damage
 - Nylon reinforced

- G04002 and G04000:
- 300 PSI burst strength
 - Solid brass couplings
 - Reinforced green nylon construction

PART NO.	DESCRIPTION	CTN/MSTR
G04001	5/8" x 60' (500 PSI) garden	1/6
G04002	5/8" x 50' (300 PSI) garden	1/6
G04000	5/8" x 75' (300 PSI) garden	1/6

12" Cushion Grip Snow Scraper



- Display box included
- 24 scrapers; priced each
- High impact plastic
- Wide scraping surface
- CARTON QUANTITIES ONLY

PART NO.	DESCRIPTION	CTN/MSTR
S80200	12" cushion grip snow scraper display	1/24

44" Telescopic Snow Brush



- Great for trucks and SUV's!
- Combination snow brush, scraper, and squeegee
- Extra thick bristles
- Aluminum handle

PART NO.	DESCRIPTION	CTN/MSTR
S80201	44" telescopic snow brush	1/24

Items marked with the Jones Stephens logo are "You Need It...We Got It" Items.

Combination Snow Pusher/Shovel



- 18" x 14" poly blade
- Deep rib molded, non-stick poly blade
- Heavy duty

PART NO.	DESCRIPTION	CTN/MSTR
S49430	Combination snow pusher/shovel	1/6

Poly Blade Snow Shovel



- 21" deep rib molded, non-stick poly blade
- High impact blade
- Lightweight
- 48" heavy duty handle

PART NO.	DESCRIPTION	CTN/MSTR
S49434	Poly blade snow shovel	1/6

D-Grip Poly Blade Snow Shovel



- 18" x 14" high-impact, non-stick poly blade
- Lightweight
- 48" heavy duty handle

PART NO.	DESCRIPTION	CTN/MSTR
S49433	D-grip poly blade snow shovel	1/6

Economy Grade Wood Handle Shovel

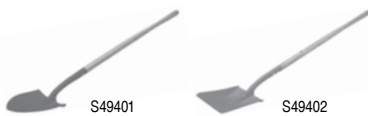

PART NO.	DESCRIPTION	CTN/MSTR
S49401	Long handle round point	1/6
S49402	Long handle square point	1/6

Fiberglass Handle Shovel



- STINGER SERIES - Fiberglass handle is 40% stronger than Federal Strength Test for long handle wood tools.
- Large steel collar adds maximum strength to handle/socket connection.
- Forward - turned step for secure foot placement

PART NO.	DESCRIPTION	AMES #	CTN/MSTR
S49412	Long handle square point	SFGLS	1/6

100 lb. Capacity Broadcast Spreader



- Fast 3 step assembly
- Up to 17,500 sq. ft. coverage
- Stainless steel gears, axle, agitator and linkage
- Heavy duty coated steel frame
- Rust/corrosion proof hopper
- X-Large 12.5" pneumatic tires
- Flow regulator on handle
- Comes with preinstalled deflectors to customize spread pattern

PART NO.	DESCRIPTION	CTN/MSTR
S44000	100 lb. capacity broadcast spreader	1/1

Hornet and Wasp Spray



- Long range spray- shoots a stream up to 20 feet, reaching nests far above ground, letting you keep a comfortable distance from the nest
- Contains no CFCs which deplete the ozone layer
- GROUND TRANSPORTATION ONLY
- ORM-D
- CARTON QUANTITIES ONLY

PART NO.	DESCRIPTION	CTN/MSTR
J40393	14 oz. can hornet & wasp spray	12/12

Blue Chalk Line Set



- Metal body reel
- 4 oz. chalk
- Carded

PART NO.	DESCRIPTION	CTN/MSTR
J40124	100' blue chalk line set	6/36

Nylon Line Reel



- Twisted nylon
- Carded

PART NO.	DESCRIPTION	CTN/MSTR
J40125	#18 x 270' nylon line reel	6/36

10 lb. Tying Twine with Dispenser Box



- 650/1
- 10 lbs.
- Includes dispenser box

PART NO.	DESCRIPTION	CTN/MSTR
T60004	10 lb. dispenser	1/1

8" Half Round Bastard File



- High speed steel plastic molded handle
- Carded double blister

PART NO.	DESCRIPTION	CTN/MSTR
J41210	8" half round bastard file	6/36

MRO

Heavy Duty Utility Knife - Carded



- Safety orange color
- Solid east metal
- Retractable
- Blade included
- Carded

PART NO.	DESCRIPTION	CTN/MSTR
K50046	Heavy duty utility knife	12/144
K50043	Replacement blades with dispenser (100/pk)	6/36

Mini Scraper with 5 Replacement Blades



PART NO.	DESCRIPTION	CTN/MSTR
K50045	Mini scraper with 5 replacement blades	6/36

20 Compartment Parts Box



- Includes extra dividers to increase the amount of compartments

PART NO.	DESCRIPTION	CTN/MSTR
T60130	20 compartment parts box	1/6

5 in 1 Painters Tool



- Solid plastic handle
- Mirror finish tempered high carbon steel blade
- Precision ground
- Full tang
- Professional grade

PART NO.	DESCRIPTION	CTN/MSTR
K50011	5 in 1 painters tool	10/100

Putty Knife



PART NO.	DESCRIPTION	CTN/MSTR
K50015	1-1/4" putty knife	12/144
K50020	1-1/2" putty knife	10/100
K50017	2" putty knife	10/100
K50016	3" putty knife	12/144
K50018	4" putty knife	10/50

Chip Brush



- Pure 100% natural white color bristle
- Epoxy set bristles for lasting durability
- Can be used with all paints, glues, and stains
- Interior/exterior
- Smooth natural wood handles

PART NO.	DESCRIPTION	CTN/MSTR
B29805	1-1/2" chip brush	36/864
B29806	2" chip brush	36/864
B29807	3" chip brush	12/432
B29808	4" chip brush	12/288

Long Handle Wire Brush with Scraper



- Long bent handle
- 3x19 rows
- For removing rust and corrosion from metals, roughing-up wood and brushing loose stucco surfaces
- Oil tempered carbon steel wire tynes
- Smooth sanded hardwood block

PART NO.	DESCRIPTION	CTN/MSTR
B29901	Long handle wire brush with scraper	12/144

Shoe Handle Wire Brush with Scraper



- Shoe handle
- 4x16 rows
- For removing rust and corrosion from metals, roughing-up wood and brushing loose stucco surfaces
- Oil tempered carbon steel wire tines
- Smooth sanded hardwood block

PART NO.	DESCRIPTION	CTN/MSTR
B29902	Shoe handle wire brush with scraper	12/144

Forced Air Propane Heater



- Variable output for both small and large spaces
- Easy-to-use electronic ignition
- Oversized handle with built-in cord wrap
- Fan-forced to heat large spaces
- Stay-cool, double-wall metal construction
- 10 ft. hose and regulator assembly included
- Runs up to 15 hours on a 20 lb. propane tank
- Safety tip-over switch
- Safety flame-out sensor
- Safety overheat protection system
- ETL approved for sale in the US and Canada

New!



PART NO.	DESCRIPTION	CTN/MSTR
CZPP100	Forced air propane heater - 10,500 to 35,000 BTUs	1/1



- Variable output for both small and large spaces
- Easy-to-use electronic ignition
- Oversized handle with built-in cord wrap
- Fan-forced to heat large spaces
- Stay-cool, double-wall metal construction
- 10 ft. hose and regulator assembly included
- Runs up to 13.5 hours on a 20 lb. propane tank
- Safety tip-over switch
- Safety flame-out sensor
- Safety overheat protection system
- ETL approved for sale in the US and Canada

New!



PART NO.	DESCRIPTION	CTN/MSTR
CZPP200	Forced air propane heater - 16,000 to 52,000 BTUs	1/1

Ceramic Heater



- Ceramic heating element
- Fan forced
- Three settings: 750/1500 watts, fan only
- Adjustable thermostat
- Safety tip-over switch
- Box: 6.6" x 5.6" x 10"

PART NO.	DESCRIPTION	CTN/MSTR
H90100	Ceramic heater	1/6

Shop Heater



- Fan forced wire element
- Three settings: 750/1500 watts, fan only
- Adjustable thermostat
- Wide stable base and adjustable tilt
- All metal body
- Long 6 ft. cord
- Padded carry handle
- Box: 10" x 7" x 11.5"

PART NO.	DESCRIPTION	CTN/MSTR
H90101	Shop heater	1/4

18" High Velocity Cradle Fan



- 3 Speeds
- High velocity output
- 180° Adjustable vertical tilt
- All metal construction
- Carry handle
- Rubber feet for stability
- Grounded cord set meets OSHA requirements
- Dimensions: 21.5" L x 12" W x 23.25" H

PART NO.	DESCRIPTION	CTN/MSTR
H90120	18" high velocity cradle fan	1/1

30" High Velocity Industrial Pedestal Fan



- 2 Speeds
- High velocity output
- Pull chain switch
- Adjustable height 39" - 60"
- Individually balanced aluminum blades
- Post spring to assist raising and lowering fan head
- Heavy, wide base for stability
- Pre-drilled holes for floor anchoring
- Grounded cord set meets OSHA requirements
- Dimensions: 32.125" L x 32.125" W x 77" H

PART NO.	DESCRIPTION	CTN/MSTR
H90122	30" high velocity industrial pedestal fan	1/1

8" Industrial Utility Blower



- High velocity, high-volume output
- Multi-purpose:
 - Cools & ventilates large areas
 - Exhaust fumes and odors
 - Dries wet areas
- All metal construction
- Rolled steel opening
- Auto reset thermal protection
- Durable carry handle
- Rubber feet for stability
- Grounded cord set meets OSHA requirements
- Dimensions: 8.875" L x 12" W x 11.25" H

PART NO.	DESCRIPTION	CTN/MSTR
H90123	8" industrial utility blower	1/1

Brute® Gray Utility Container, Less Lid



- All-plastic, professional-grade construction will not rust, chip, or peel and resists dents
- Strong, snap-on lids provide secure, stable stacking
- Certified to NSF-Standard #2 and Standard #21

PART NO.	DESCRIPTION	CTN/MSTR
G80003	32 gallon	1/6
G80002	44 gallon	1/4
G80001	55 gallon	1/3

Lid for Brute® Utility Containers



- Strong, snap-on lid provides secure, stable stacking
- Certified to NSF-Standard #2 and Standard #21

PART NO.	DESCRIPTION	CTN/MSTR
G80006	Fits 32 gallon (G80003)	1/6
G80005	Fits 44 gallon (G80002)	1/4
G80004	Fits 55 gallon (G80001)	1/3

Dolly for Brute® Utility Containers



- Fits 32, 44, and 55 gallon BRUTE® Containers
- Swivel casters offer better mobility through work areas
- Heavy-duty 3" casters
- Attach waste containers with easy twist-on/twist-off action

PART NO.	DESCRIPTION	CTN/MSTR
G80007	Fits 32, 44, and 55 gallon	1/2

Yard Tilt Truck



- Durability of modern structural foam technology
- Ergonomic "steering wheel" handle for better handling
- Non-marking casters
- Unibody design promotes a more discreet appearance in public areas
- Fits through standard commercial doorways and onto elevators easily



PART NO.	DESCRIPTION	CTN/MSTR
G80015	3/4 cubic yard tilt truck (600 lb. capacity)	1/1
G80016	1/2 cubic yard tilt truck (450 lb. capacity)	1/1

Lipped Utility Cart with 2 Shelves



- Durable structural foam construction won't leak, rust, chip, dent, or peel
- Deep pocket shelves keep contents in place
- TPR casters absorb shock and provide floor surface protection and quiet operation
- Heavy duty models have variable grip-height handle



PART NO.	DESCRIPTION	CTN/MSTR
G80011	16" x 30" heavy duty (500 lb. capacity)	1/1
G80010	24" x 36" heavy duty (500 lb. capacity)	1/1
G80013	16" x 30" (500 lb. capacity)	1/1
G80012	24" x 36" (500 lb. capacity)	1/1

Nylon Cable Ties



Natural Color



Black

- Standard size
- Nylon
- Priced per tie
- CARTON QUANTITIES ONLY

PART NO.	DESCRIPTION	CTN/MSTR
J40107	7" long (1/16" - 1-3/4") natural	100/6600
J40115	15" (5/16") black	100/2300

Heat and UV Stabilized Nylon Cable Ties



- Heat & UV stabilized nylon-66
- Priced per bag of 100

PART NO.	DESCRIPTION	CTN/MSTR
J40433	4" 18lb. natural cable ties	12/72
J40434	6" 18lb. natural cable ties	12/72
J40435	8" 40lb. natural cable ties	12/72
J40436	11" 50lb. natural cable ties	12/72
J40437	14" 50lb. natural cable ties	12/72
J40438	17" 50lb. natural cable ties	12/72
J40443	4" 18lb. black cable ties	12/72
J40444	6" 18lb. black cable ties	12/72
J40445	8" 40lb. black cable ties	12/72
J40446	11" 50lb. black cable ties	12/72
J40447	14" 50lb. black cable ties	12/72
J40448	17" 50lb. black cable ties	12/72

MRO

Pointing Trowel with Wood Handle



- Fine grained hardwood handle

PART NO.	DESCRIPTION	CTN/MSTR
B29500	5" pointing trowel with wood handle	12/120

Masonry Drill Bit



- Carded

PART NO.	DESCRIPTION	CTN/MSTR
S41348	1/8" masonry drill bit	6/48
S41364	3/16" masonry drill bit	6/48
S41450	1/4" masonry drill bit	6/48
S41452	5/16" masonry drill bit	6/48
S41453	3/8" masonry drill bit	6/48
S41455	1/2" masonry drill bit	6/48

Wood Spade Drill Bit



- Carded

PART NO.	DESCRIPTION	CTN/MSTR
B24250	1/2" wood spade drill bit	6/48
B24263	5/8" wood spade drill bit	6/48
B24175	3/4" wood spade drill bit	6/48
B24188	7/8" wood spade drill bit	6/144
B24200	1" wood spade drill bit	6/48
B24213	1-1/8" wood spade drill bit	6/48
B24225	1-1/4" wood spade drill bit	6/48
B24251	1-1/2" wood spade drill bit	6/48

9" Torpedo Level with Magnetic Strip



- Top read window simplifies readings in confined areas
- High impact ABS plastic frame
- Full length magnetic edge on one side
- Carded

PART NO.	DESCRIPTION	CTN/MSTR
J40102	9" torpedo level with magnetic strip	6/36

Locking Measuring Tape



- 33 ft.
- Extra heavy duty rubber case
- Power locking

PART NO.	DESCRIPTION	CTN/MSTR
J40084	1-1/4" x 33' tape measure	1/15

Power Locking Measuring Tape



- Positive thumb lock
- Chrome plated case
- Smooth power return
- Stainless belt clip
- True zero blade hook
- P.R. approved

PART NO.	DESCRIPTION	CTN/MSTR
J40346	1" x 25' tape	6/36

Caulking Gun



- 9" barrel
- Drop-in half barrel type
- Painted steel

PART NO.	DESCRIPTION	CTN/MSTR
C35090	Caulking gun	1/10

Stop Flow™ Style Parallel Smooth Hex Rod Caulking Gun



- For standard cartridge
- Perfectly balanced
- Deep milled cut teeth built in spout cutter
- Nozzle clean out tool
- D-ring and wrist strap ladder hook

PART NO.	DESCRIPTION	CTN/MSTR
C35092	Stop Flow™ style parallel smooth hex rod	1/12

100% Silicone Caulk



- Flexible, easy to use
- 50 year life
- Will not stain or bleed
- Seal, bond or insulate
- CARTON QUANTITIES ONLY

PART NO.	DESCRIPTION	CTN/MSTR
J40208	10.1 oz. tube CLEAR caulk	12/12
J40288	10.1 oz. tube WHITE caulk	12/12

Duct Tape



- Premium grade, waterproof non-elastic reinforced cloth
- Pressure sensitive; vapor and flame resistant
- CARTON QUANTITIES ONLY

PART NO.	DESCRIPTION	THICKNESS	CTN/MSTR
T20020	2" x 60 yds (gray)	8.5 mil.	24/24
T20023	2" x 60 yds (black)	10 mil.	24/24

Box Sealing Tape



PART NO.	DESCRIPTION	CTN/MSTR
T20040	2" x 55 yds	1/36
T20041	2" x 110 yds	1/36
T20050	Dispenser only	1/24

WD-40® Lubricant



- Cleans
- Protects against rust and corrosion
- Lubricates
- Penetrates stuck metal parts
- Displaces moisture
- ORM-D
- GROUND TRANSPORTATION ONLY
- CARTON QUANTITIES ONLY

PART NO.	DESCRIPTION	CTN QTY
S95800	8 oz. can lubricant low VOC	12

Orange Extension Cord



- Safety orange color
- Heavy duty
- Outdoor/grounded
- ETL Listed



PART NO.	DESCRIPTION	CTN/MSTR
E25000	16/3 SJT 15 ft. extension cord	6/24
E25001	16/3 SJT 25 ft. extension cord	6/24
E25002	16/3 SJT 50 ft. extension cord	6/12
E25004	16/3 SJT 100 ft. extension cord	1/6
E25005	12/3 SJT 25 ft. extension cord	1/8
E25006	12/3 SJT 50 ft. extension cord	1/6
E25007	12/3 SJT 100 ft. extension cord	1/4
E25040	14/3 SJT 25 ft. extension cord	1/12
E25041	14/3 SJT 50 ft. extension cord	1/8
E25042	14/3 SJT 100 ft. extension cord	1/4

Lighted End Extension Cord



- 14/3 AWG SJTW
- Orange with black stripe
- All weather
- Heavy duty

PART NO.	DESCRIPTION	CTN/MSTR
E25045	25' lighted end extension cord	2/12
E25046	50' lighted end extension cord	2/8

Round Extension Cord Power Block



- 14/3 SJT
- 15 AMP
- 125 V
- ETL Listed



PART NO.	DESCRIPTION	CTN/MSTR
E25010	3 ft. round extension cord block	12/48

Items marked with the Jones Stephens logo are "You Need It... We Got It" Items.

Outlet Adapter



- Converts 3 prong cord to 2 prong
- ETL Listed



PART NO.	DESCRIPTION	CTN/MSTR
E25320	3 to 2 prong outlet adapter	1/500

6 Outlet Power Strip with Surge Protector



- Indoor use only
- Reset button
- Hi-impact, Hi-strength plastic
- Lighted On/Off switch
- ETL Listed



PART NO.	DESCRIPTION	CTN/MSTR
E25300	6 outlet, 90 joules	1/12
E25301	6 outlet, 735 joules	3/18

7 Outlet Power Strip with Surge Protector



- Indoor use only
- Outlets spaced apart for large AC adapters
- 3' long
- 14/3 AWG
- Grounded cord
- Lighted On/Off switch
- ETL Listed



PART NO.	DESCRIPTION	CTN/MSTR
E25302	7 outlet, 300 joules	1/12

Portable Halogen Work Light



- 6 ft. grounded
- 500 watt
- Power cord
- Adjustable frame

PART NO.	DESCRIPTION	CTN/MSTR
E25250	500 watt halogen light	1/6
H500X2	(2) replacement bulbs - RSC base T3 (J-type)	12/144

Clamp-On Light



- Reflector lamp for general shop and industrial applications
- 8" shade, 6 ft. cord
- On/Off switch
- Use 75 watt max type "A" bulb (not included)
- Boxed



PART NO.	DESCRIPTION	CTN/MSTR
E25251	Clamp-on light with 8" shade	1/4

Orange Trouble Light



- Industrial quality
- 25 ft. 16/3 SJT cord
- 3-prong side outlets
- Metal cage

PART NO.	DESCRIPTION	CTN/MSTR
E25021	Orange trouble light with metal cage	1/12

8 LED Flashlight



- With magnifying lenses
- Push button switch
- Impact resistant
- Comfort grip
- Handy strap
- Uses 3 AAA batteries (included)

PART NO.	DESCRIPTION	CTN/MSTR
F20052	8 LED flashlight	6/48

24 LED Twist Light



- (2) 12 LED super bright lights
- Versatile flexible body
- Removable heads to use as single flashlights
- Use for emergencies, repairs and more!
- Uses 6 AAA batteries - 3 per side (not included)

PART NO.	DESCRIPTION	CTN/MSTR
F20050	24 LED twist light	1/6

1 Watt LED Flashlight



- With adjustable beam
- Narrow to wide focus
- Aluminum body
- Wrist strap
- 3 light options: high, low and safety flash
- Uses 3 AAA batteries (not included)

PART NO.	DESCRIPTION	CTN/MSTR
F20054	1 watt LED flashlight with adjustable beam	6/48

3 Watt LED Flashlight



- Aluminum body
- Large easy grip
- 3 light options: high, low and safety flash
- Uses 3 AAA batteries (not included)

PART NO.	DESCRIPTION	CTN/MSTR
F20053	3 watt LED flashlight	6/48

MRO

5 Watt LED Flashlight



- Aluminum body
- Includes charger
- 3 light options: high, low and safety flash
- Rechargeable lithium ion battery (included)

PART NO.	DESCRIPTION	CTN/MSTR
F20055	5 watt LED flashlight with charger	6/48

27 LED Utility Light



- With magnetic back and folding swivel hook
- 24 LED light
- 3 LED flashlight
- Push button switch
- Uses 3 AAA batteries (included)
- Display contains 12 lights
- CARTON QUANTITIES ONLY

PART NO.	DESCRIPTION	CTN/MSTR
F20051	27 LED utility light display	12/48

Industrial Swivel-Lite Flashlight



F20016



F20017

- Contractor grade construction
- Sure grip rubber handles

PART NO.	DESCRIPTION	CTN/MSTR
F20017	Flashlight for D batteries	1/6

Rayovac Floating Lantern and Battery



F20003



F20004



F20005

- 6-volt F20004 battery included
- Heavy duty battery priced each

PART NO.	DESCRIPTION	CTN/MSTR
F20003	Floating lantern with battery	1/6
F20004	6 volt spring top - battery only	1/12
F20005	6 volt screw top - battery only	1/4

Rayovac Industrial Flashlight



- Yellow flashlights with ring hangers

PART NO.	DESCRIPTION	CTN/MSTR
F20001	2 cell D size flashlight	1/6
F20002	3 cell D size flashlight	1/6

4 D/6 Volt Swivel-Lite



- Contractor grade construction
- Krypton bulb, spare bulb holder
- Floats in water (with beam up)
- Long range beam
- 45° swivel for hands-free use
- Comfort-grip handle, push-button switch
- No batteries included
- Can use 6V lantern battery for additional power

PART NO.	DESCRIPTION	CTN/MSTR
F20018	4D/ 6-volt swivel-lite	1/6

Sportsman LED Head-Lite



- New technology unique 3-way hands-free L.E.D. system
- Close range use super white L.E.D., "Night vision" 2 super red L.E.D., Long range beam-krypton bulb
- Batteries last 20 times longer with L.E.D. bulbs than normal bulbs
- Rubber spot-flood reflector, head rotates 180° compact design, comfort-grip band
- Weatherproof, heavy duty construction

PART NO.	DESCRIPTION	CTN/MSTR
F20019	Sportsman LED head-lite	1/4

Duracell® Alkaline Batteries



- Priced per pack
- Carded
- PACK QUANTITIES ONLY

PART NO.	DESCRIPTION	CTN/MSTR
F20020	AAA alkaline batteries - 2 pack	1/50
F20021	AAA alkaline batteries - 4 pack	1/50
F20022	AA alkaline batteries - 2 pack	1/50
F20023	AA alkaline batteries - 4 pack	1/50
F20024	C alkaline batteries - 2 pack	1/30
F20025	D alkaline batteries - 2 pack	1/48
F20026	9 volt alkaline battery	1/50

Rayovac® Industrial Batteries



- Priced per battery
- PACK QUANTITIES ONLY

PART NO.	DESCRIPTION	CTN/MSTR
F20006	Heavy duty C batteries	6/72
F20007	Heavy duty D batteries	6/72
F20004	6 volt spring top - battery only	12/12
F20005	6 volt screw top - battery only	4/4
F20012	AAA alkaline batteries	8/96
F20008	AA alkaline batteries	8/96
F20009	9 volt alkaline batteries	6/72
F20010	C alkaline batteries	6/72
F20011	D alkaline batteries	6/72

Laminated Padlock with Keys



- Includes 2 keys
- Laminated
- Hardened steel shackle
- Shackle height is 1"
- Precision engineered double locking
- Brass pin cylinder - 5 PIN
- Protective bumper
- Clamshell pack

PART NO.	DESCRIPTION	CTN/MSTR
L26003	1-3/4" standard shackle padlock with keys	12/72

WordLock® 4 Dial Utility Padlock



- High security
- Heavy duty
- Brass color
- Resettable
- 1-1/2" shackle
- Clamshell pack

WordLock®

PART NO.	DESCRIPTION	CTN/MSTR
L26006	4 dial utility padlock	3/12

WordLock® Stor-More Key Safe™



- More space than traditional key safes - can hold larger items
- Can hold keys, key fobs, credit cards and much more
- Mounts on door or wall
- 10,000 possible combinations
- Resettable
- Reinforced stainless steel body to withstand sawing and hammering
- Clamshell pack

WordLock®

PART NO.	DESCRIPTION	CTN/MSTR
L26008	Key safe	3/12

WordLock® Loop and Lock™ with MatchKey



- 8 ft.
- Ultimate utility cable lock
- Heavy duty flexible steel cable
- Integrated lock head means no padlocks to lose
- Ideal for securing ladders and other tools
- Key color matches cable color
- Word on key matches word on lock
- Unique key shape
- Carded

WordLock®

PART NO.	DESCRIPTION	CTN/MSTR
L26005	8 ft. black Loop and Lock with matchkey	4/16

4 Dial Combination Padlock



- Heavy duty, solid brass
- Resettable
- Hardened shackle
- Shackle height is 1"
- Clamshell pack

PART NO.	DESCRIPTION	CTN/MSTR
L26015	4 dial combination padlock	6/48

MRO

MERCHANDISING

Shelf Solutions	412-417
Pegboard Solutions	418-424
Counter Solutions	425-426

*Published March 2017. List prices can be found in list price book and on our website.

'Keep 'Em at Your Counter'!™

CUSTOM MERCHANDISING SOLUTIONS

Increase your revenue, stop missing high margin sales.



JONES  STEPHENS™

— We Got It —

At JONES STEPHENS... We Know Merchandising!

Jones Stephens merchandising solutions are perfect for:
FITTINGS • MRO • SPECIALTIES AND REPAIR • TOILET SEATS • TUBULAR • AND MORE

Shelf Solutions



Pegboard Solutions



Counter Solutions



Our team understands that each counter area is different and that market needs are not always alike. That's why we've enhanced our in-house customization capabilities to configure merchandising solutions to meet your specific needs.

Whether you need a pegboard solution for hanging products, shelf or wall solutions for tight spaces, an eye-catching endcap display, or a self-service solution ... We Got It! And we'll help you market it, too. We'll supply the signage, tags, labels, and all marketing materials needed to help you sell.

Choose from over 30 pre-planogrammed merchandising options, or customize any of them to meet your needs.

To order any merchandising solution, please contact your local Sales Representative or your Regional Sales Manager.

Available Marketing Materials Include:

Merchandising Tags



Planogram



Header



BUILD YOUR OWN DISPLAY HERE!

**see pages 412-416 for suggested pre-planogrammed assortments*

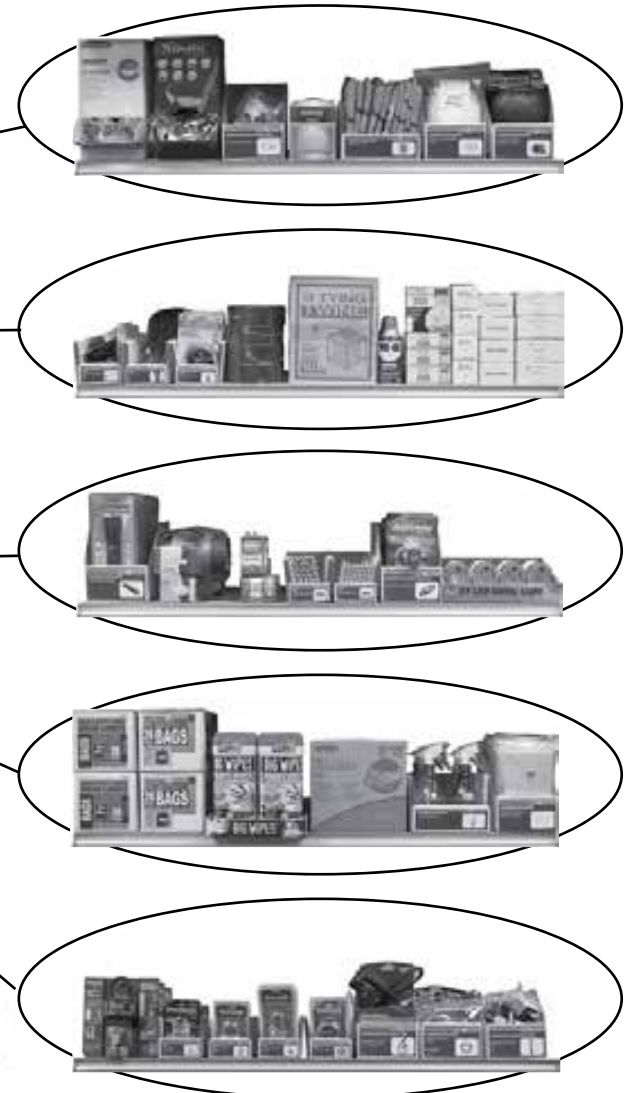

Safety 1 Pre-Planogrammed MRO Shelf



* custom display options available

PART NO.	DESCRIPTION	SUGGESTED QUANTITY
G30030	Nemesis Safety Glasses, Camo/Bronze - Dispenser Box of 12 pairs	2
G30016	Hellraiser Safety Glasses, Smoke	12
G30003	Visio Safety Glasses, Clear	24
G30021	Dust Masks	12
B05090	Orange Safety Vest	12
B05011	Protective Shoe Covers, 10 Pair	10
K01120	Heavy Duty Foam Economy Knee Pads	10

DISPLAY INCLUDES:
BIN BOXES AND LABELS. OTHER MARKETING MATERIALS AVAILABLE UPON REQUEST.

Safety 2 Pre-Planogrammed MRO Shelf



* custom display options available

PART NO.	DESCRIPTION	SUGGESTED QUANTITY
G50251	Vinyl Disposable Gloves, 20 Pack	20
G50215*	Nitrile Gloves	24
G50204*	Work Gloves, Leather Palm, Low Safety Cuff for Display	24
G50200*	Work Gloves, Brown Cotton Jersey for Display	24
G50230	Blue Nitrile Gloves, M/LG	24
G50231	Blue Nitrile Gloves, L/XL	24
G50212	Disposable Blue Latex Gloves	24
B05021*	X-Large Disposable Coverall	25

*Carton Quantity Only Item

DISPLAY INCLUDES:
BIN BOXES AND LABELS. OTHER MARKETING MATERIALS AVAILABLE UPON REQUEST.

Safety 3 Pre-Planogrammed MRO Shelf



* custom display options available

PART NO.	DESCRIPTION	SUGGESTED QUANTITY
H40002	Safety Hat White with 4-point Pin Lock Suspension	12
H40004	Safety Hat White with 4-point Ratchet Suspension	12
B05015	Shubee Shoe Covers	4
E85000*	Ready Fit Corded Ear Plugs	200
J43300	3" x 300' Caution Tape	12
G50215*	Nitrile Gloves	24

*Carton Quantity Only Item

DISPLAY INCLUDES:
BIN BOX AND LABEL. OTHER MARKETING MATERIALS AVAILABLE UPON REQUEST.

Contractor Tools 1 Pre-Planogrammed MRO Shelf



* custom display options available

PART NO.	DESCRIPTION	SUGGESTED QUANTITY
H90120	18" High Velocity Cradle Fan	6
H90123	8" Industrial Utility Blower	6
E25250	Portable Halogen Work Light	8

DISPLAY INCLUDES:
MARKETING MATERIALS AVAILABLE UPON REQUEST.



Contractor Tools 2 Pre-Planogrammed MRO Shelf



* custom display options available

PART NO.	DESCRIPTION	SUGGESTED QUANTITY
J40102	9" Torpedo Level with Magnetic Strip	24
J40115*	15" Cable Ties, Black	200
J40346	1" x 25' Measuring Tape, Carded	24
T20023*	2" x 60 yds. Duct Tape 10 mil, Black	24
T60004	10 lb. Tying Twine with Dispenser Box	2
S95800*	8 oz. WD-40® Lubricant, Low VOC for California	12
L95500	Carbon Monoxide Alarm	6
P24001	2" Green Drain Waterless Trap Seal	6
P24002	3" Green Drain Waterless Trap Seal	12
P24004	4" Green Drain Waterless Trap Seal	6

*Carton Quantity Only Item

DISPLAY INCLUDES:
BIN BOXES AND LABELS. OTHER MARKETING MATERIALS AVAILABLE UPON REQUEST.

Contractor Tools 3 Pre-Planogrammed MRO Shelf



* custom display options available

PART NO.	DESCRIPTION	SUGGESTED QUANTITY
H90100	Ceramic Heater	12
H90101	Shop Heater	12
E25250	Portable Halogen Work Light	12

DISPLAY INCLUDES:
MARKETING MATERIALS AVAILABLE UPON REQUEST.

Electrical 1 Pre-Planogrammed MRO Shelf



* custom display options available

PART NO.	DESCRIPTION	SUGGESTED QUANTITY
F20053	3 Watt LED Flashlight	12
F20003	Rayovac Floating Lantern with Battery	10
F20004	Rayovac Floating Lantern Battery Only, 6 Volt Spring Top	12
F20008*	Rayovac Heavy Duty Alkaline Industrial Batteries, AA Size	96
F20012*	Rayovac Heavy Duty Alkaline Industrial Batteries, AAA Size	96
F20019	Sportsman L.E.D. Head-Lite	12
F20051*	27 LED Utility Light with Magnetic Back and Folding Swivel Hook, Display with 12 Lights	24

*Carton Quantity Only Item

DISPLAY INCLUDES:
BIN BOXES AND LABELS. OTHER MARKETING MATERIALS AVAILABLE UPON REQUEST.

Electrical 2 Pre-Planogrammed MRO Shelf



* custom display options available

PART NO.	DESCRIPTION	SUGGESTED QUANTITY
E25021	16/3 25 ft. Trouble Light with Metal Cage	8
E25045	14/3 25 ft. Lighted End Extension Cord	8
E25046	14/3 50 ft. Lighted End Extension Cord	8
E25000	16/3 15 ft. Orange Extension Cord	8
E25001	16/3 25 ft. Orange Extension Cord	8
E25002	16/3 50 ft. Orange Extension Cord	8
E25004	16/3 100 ft. Orange Extension Cord	8

DISPLAY INCLUDES:
MARKETING MATERIALS AVAILABLE UPON REQUEST.

Cleaning 1 Pre-Planogrammed MRO Shelf



* custom display options available

PART NO.	DESCRIPTION	SUGGESTED QUANTITY
G02050	55 Gallon Drum Liner, 20 Count	10
G02042	42 Gallon Trash Bag, 20 Count	10
B05050*	Heavy Duty Big Wipes, 80 Count Tub	16
B05003*	Wypall Teri Towels, 9-3/4" x 16-3/4" x 125 sheets	10
B25001	16 oz. Spray Bottle, Clear	24
S50002	Commercial Sponge, Large Cellulose	48

*Carton Quantity Only Item

DISPLAY INCLUDES:
BIN BOXES AND LABELS. OTHER MARKETING MATERIALS AVAILABLE UPON REQUEST.

Cleaning 2 Pre-Planogrammed MRO Shelf



* custom display options available

PART NO.	DESCRIPTION	SUGGESTED QUANTITY
G02010	6' x 9' Cotton Canvas Drop Cloth	24
G02011	9' x 12' Cotton Canvas Drop Cloth	24
B05001	4 lb. Box of Rags	10
D50000	9' x 12' Plastic Drop Cloth	24
B05026	Cotton Terry Cloth Towels, 8 pack	24

DISPLAY INCLUDES:
BIN BOXES AND LABELS. OTHER MARKETING MATERIALS AVAILABLE UPON REQUEST.

Security Pre-Planogrammed MRO Shelf



* custom display options available

PART NO.	DESCRIPTION	SUGGESTED QUANTITY
L26008	Wordlock® Stor-More Key Safe	12
L26006	Wordlock® 4 Dial Utility Padlock	12
L26015	2" Standard Shackle 4 Dial Padlock	12
L26002	1-1/2" Long Shackle Padlock with Keys	12
L26007	Wordlock® 4 Dial Discus Lock	12
L26005	Wordlock® Loop 'N Lock with MatchKey, Black	12
L26009	6' x 5/16" Flexible Cable Lock, Clear	12
L26018	4' Steel Hardened Security Chain	8

DISPLAY INCLUDES:
BIN BOXES AND LABELS. OTHER MARKETING MATERIALS AVAILABLE UPON REQUEST.

Outdoor Pre-Planogrammed MRO Shelf



* custom display options available

PART NO.	DESCRIPTION	SUGGESTED QUANTITY
G04002	5/8" x 50' Garden Hose (300 PSI)	8
G04026	3/4" x 50' Rubber Garden Hose	8
J40393*	Hornet and Wasp Spray	24
G04030	Insulated Hoze Nozzle	24
G04031	4" Brass Hose Nozzle	24

*Carton Quantity Only Item

DISPLAY INCLUDES:
BIN BOXES AND LABELS. OTHER MARKETING MATERIALS AVAILABLE UPON REQUEST.

Pre-Planogrammed 4ft. MRO Display



PART NO.	DESCRIPTION	SUGGESTED QUANTITY
ROW 1		
B05050*	Heavy Duty Big Wipes, 80 Count Tub	16
B05003*	Wypall Teri Towels, 125 sheets	10
B05001	4 lb. Box of Rags	5
G02042	42 Gallon Trash Bag, 20 Count	36
ROW 2		
J40393*	14 oz. Hornet and Wasp Spray	12
S95700*	8 oz. WD-40® Lubricant	12
J40208* (S)	10.1 oz. 100% Silicone Caulk, Clear	12
J40288*	10.1 oz. 100% Silicone Caulk, White	12
T20023*	2" x 60 yds. Duct Tape 10 mil, Black	24
T20020*	2" x 60 yds. Duct Tape 8.5 mil, Gray	24
J43300 (S)	3" x 300' Caution Tape	16
P24001	2" Green Drain Waterless Trap Seal	12
P24002	3" Green Drain Waterless Trap Seal	12
P24004	4" Green Drain Waterless Trap Seal	6
ROW 3		
H40002	White Safety Hat with 4-point Pin Lock Suspension	6
H40004	White Safety Hat with 4-point Ratchet Suspension	6
B05015	Shabee Shoe Covers	4
G30021	Dust Masks (50/box)	20
S95250	Urinal Screen	72
S95251*	Refills for Urinal Screen	24
ROW 4		
G02010	6' x 9' Cotton Canvas Drop Cloth	6
G02011	9' x 12' Cotton Canvas Drop Cloth	4
G50250	100 Vinyl Gloves	10
G50212	Disposable Blue Latex Gloves	10
G50230	Blue Nitrile Gloves, M/LG	10
G50231	Blue Nitrile Gloves, L/XL	10
ROW 5		
G04001	5/8" x 60' Garden Hose (500 PSI)	6
E25005	12/3 25 ft. Orange Extension Cord	4
E25006	12/3 50 ft. Orange Extension Cord	3
E25021	16/3 25 ft. Trouble Light with Metal Cage	3
E25250	Portable Halogen Work Light	3

*Carton Quantity Only Item

DISPLAY INCLUDES:
HEADER. OTHER MARKETING MATERIALS AVAILABLE UPON REQUEST.

Available Marketing Materials Include:

Bin Boxes with Labels



Tilt Bins with Labels



Planogram

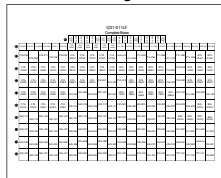

Header



We Got It™

A World and Main company

***BUILD YOUR
OWN DISPLAY
HERE!***

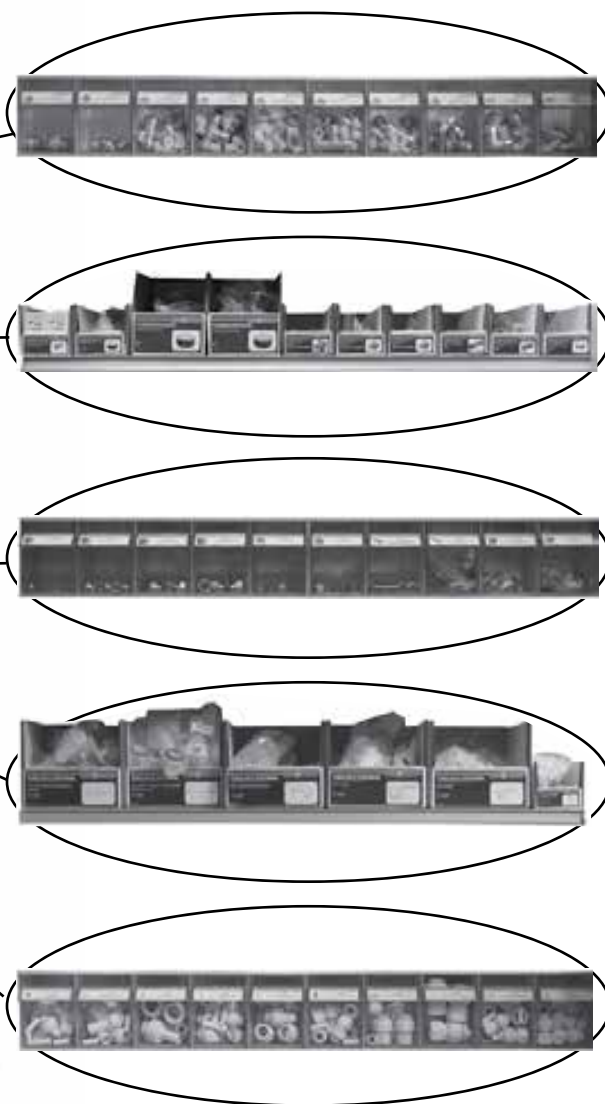

Available Marketing Materials Include:

Reorder Tags



Pegboard Hooks



Pegboard with Header



Planogram

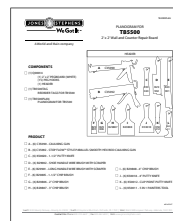

BUILD YOUR OWN DISPLAY HERE!

**see pages 418-424 for suggested pre-planogrammed assortments*

Ideal for:

- CONTRACTOR SPECIALTIES AND MRO PRODUCTS
- TOOLS
- REPAIR

Toilet Repair Board

Display Part No. TB5000



* custom display options available

PART NO.	DESCRIPTION	QTY
T02070	Integral float fill valve	6
T01001	Chrome plated fit-all tank trip lever - 8" brass arm with metal spud and nut	8
S04216	9" flexible SS connector - 3/8" OD x 7/8" BC	10
S04415	12" braided nylon connector - 3/8" OD x 7/8" BC	10
S04217	12" flexible SS connector - 3/8" OD x 7/8" BC	10
S04222	16" flexible SS connector - 1/2" OD x 7/8" BC	10
S04219	20" flexible SS connector - 3/8" OD x 7/8" BC	10
C04004	Carded blue fit-all vinyl flapper	8
C85000	Closet flange repair ring	6
C87100	Gapper repair flange	6

DISPLAY INCLUDES:

(1) 2' x 2' PEGBOARD, (15) PEG HOOKS, (1) HEADER, REORDER TAGS, & PLANOGRAM

Hardware Board

Display Part No. TB5100



* custom display options available

PART NO.	DESCRIPTION	QTY
B24250	1/2" wood spade drill bit	4
B24263	5/8" wood spade drill bit	4
B24175	3/4" wood spade drill bit	4
B24188	7/8" wood spade drill bit	4
B24200	1" wood spade drill bit	4
B24213	1-1/8" wood spade drill bit	4
B24225	1-1/4" wood spade drill bit	4
B24251	1-1/2" wood spade drill bit	4
K50043	Heavy duty utility knife replacement blades with dispenser	6
K50046	Heavy duty utility knife	8
S41452	5/16" masonry drill bit	4
S41453	3/8" masonry drill bit	4
S41455	1/2" masonry drill bit	4
S41348	1/8" masonry drill bit	4
S41364	3/16" masonry drill bit	4
S41450	1/4" masonry drill bit	4
S06021	7 piece hollow shaft nut driver set	4
J40345	3/4" x 16' measuring tape	4
J40346	1" x 25' measuring tape	4
J40102	9" torpedo level with magnetic strip	6

DISPLAY INCLUDES:
(1) 2' x 2' PEGBOARD, (20) PEG HOOKS, (1) HEADER, REORDER TAGS,
& PLANOGRAM

Security Board

Display Part No. TB5200



* custom display options available

PART NO.	DESCRIPTION	QTY
L26018	4" steel hardened security chain	2
L26001	1-1/2" standard shackle padlock with keys	4
L26003	1-3/4" standard shackle padlock with keys	4
L26004	1-3/4" long shackle padlock with keys	4
L26015	4 dial combination padlock	4
L26016	1-3/4" square body steel padlock	4
L26017	2-5/8" round body steel padlock	4
L26008	Stor-More Key Safe®	2
L26005	8 ft. black Loop and Lock™ with matchkey	4
L26007	4 dial discus lock	4
L26010	14' x 3/8" black flexible cable lock	4

DISPLAY INCLUDES:
(1) 2' x 2' PEGBOARD, (15) PEG HOOKS, (1) HEADER, REORDER TAGS,
& PLANOGRAM

Gloves Board

Display Part No. TB5300



* custom display options available

PART NO.	DESCRIPTION	QTY
G50223	14" industrial smooth hands rubber gloves, 30 mil	8
G50204	Leather palm low safety cuff gloves	12
G50300	Economy brown cotton jersey gloves	12
G50229	White cotton gloves with PVC dots	12
G50228	White canvas work gloves	12
G50225	Polyester nitrile dipped palm gloves	12
G50302	8 pack disposable gloves	16

DISPLAY INCLUDES:
(1) 2' x 2' PEGBOARD, (15) PEG HOOKS, (1) HEADER, REORDER TAGS,
& PLANOGRAM

Cable Ties Board

Display Part No. TB5400



* custom display options available

PART NO.	DESCRIPTION	QTY
J40438	17" 50lb. natural cable ties	6
J40437	14" 50lb. natural cable ties	6
J40435	8" 40lb. natural cable ties	8
J40434	6" 18lb. natural cable ties	8
J40447	14" 50lb. black cable ties	6
J40448	17" 50lb. black cable ties	6
J40444	6" 18lb. black cable ties	8
J40445	8" 40lb. black cable ties	8

DISPLAY INCLUDES:
(1) 2' x 2' PEGBOARD, (15) PEG HOOKS, (1) HEADER, REORDER TAGS,
& PLANOGRAM

Wall and Counter Repair Board

Display Part No. TB5500



* custom display options available

PART NO.	DESCRIPTION	QTY
C35090	Caulking gun	6
C35092	Stop Flow™ style parallel smooth hex rod caulking gun	6
K50020	1-1/2" putty knife	6
B29902	Shoe handle wire brush with scraper	6
B29901	Long handle wire brush with scraper	6
B29805	1-1/2" chip brush	6
B29806	2" chip brush	6
B29807	3" chip brush	6
B29808	4" chip brush	6
K50018	4" putty knife	6
K50012	Clip point putty knife	6
K50011	5 in 1 painters tool	6

DISPLAY INCLUDES:

(1) 2' x 2' PEGBOARD, (15) PEG HOOKS, (1) HEADER, REORDER TAGS, & PLANOGRAM

Flashlight Board

Display Part No. TB5600



* custom display options available

PART NO.	DESCRIPTION	QTY
F20054	1 watt LED flashlight with adjustable beam	4
F20055	5 watt LED flashlight with charger	4
F20001	2 cell D size flashlight	4
F20017	Industrial swivel-lite D size flashlight	4
F20053	3 watt LED flashlight	4
F20052	8 LED flashlight	4
F20019	Sportsman LED head-lite	6
F20003	Floating lantern with battery	4

DISPLAY INCLUDES:

(1) 2' x 2' PEGBOARD, (15) PEG HOOKS, (1) HEADER, REORDER TAGS, & PLANOGRAM

Wrench and Pliers

Display Part No. TB4000



* custom display options available

PART NO.	DESCRIPTION	QTY
J40021	Compression sleeve puller	6
J40035	Lavatory nut removal tool	6
P60001	Slip jaw pliers (2-1/8" capacity / 10" long)	6
J40019	Do All plumbers wrench	6
J45010	Universal drain wrench	6
J40491	Angle compression stop wrench	6
J40490	Dual kwik tite wrench	6
T60060	 No hub torque wrench	6



DISPLAY INCLUDES:
(1) 2' x 2' PEGBOARD, (9) PEG HOOKS, (1) HEADER, REORDER TAGS,
& PLANOGRAM

Cutter Tool Board

Display Part No. TB4100



* custom display options available

PART NO.	DESCRIPTION	QTY
P70035	2" PVC one-handed pipe cutter	6
P70018	 1-1/4" PVC pipe cutter	6
J40260	 1/2" Copper tube cutter	6
J40261	3/4" Copper tube cutter	6
P70019	1-1/4" PVC pipe cutter replacement blade	6
P70052	Mini tubing cutter-1/8"-7/8" (uses P70055 repl. blade)	6
P70067	Mini tubing cutter replacement blades (2)	6
P70056	Enclosed feed tube cutter replacement cutter wheels (2)	6
P70064	Enclosed feed tube cutter (1/8" x 1-3/16")	6

DISPLAY INCLUDES:
(1) 2' x 2' PEGBOARD, (9) PEG HOOKS, (1) HEADER, REORDER TAGS,
& PLANOGRAM

Specialty Tool Board

Display Part No. TB4200



* custom display options available

PART NO.	DESCRIPTION	QTY
J40080	Bar flaring tool	6
J40830	E-Z shear inside pipe cutter	6
J40026	4-way P.O. plug wrench	6
J45015	Stem and cartridge wrench	6
B11010	Basin wrench (10"-17" telescoping)	6
J40021	Compression sleeve puller	6
J40010	Faucet handle puller standard unit	6
J40018	Extract-a-drain tool	6
J40015	Hex key wrench set	6

DISPLAY INCLUDES:
 (1) 2' x 2' PEGBOARD, (9) PEG HOOKS, (1) HEADER, REORDER TAGS,
 & PLANOGRAM

Saw Tool Board

Display Part No. TB4300



* custom display options available

PART NO.	DESCRIPTION	QTY
S49008	12" E-Z stroke pipe saw	6
S49007	12" E-Z stroke pipe saw replacement blade	6
S49200	Hardwood 250 speed handsaw	6
S49005	8" E-Z stroke pipe saw	6
S49006	8" E-Z stroke pipe saw replacement blade	6
S49036	36" cable saw	6
S50060	6" close quarters hacksaw	6
S49236	36" T-handle cable saw	6
S50061	6" close quarters hacksaw replacement blades (5)	6 Tubes

DISPLAY INCLUDES:
 (1) 2' x 2' PEGBOARD, (9) PEG HOOKS, (1) HEADER, REORDER TAGS,
 & PLANOGRAM

Items marked with the Jones Stephens logo are "You Need It...We Got It" Items.

Strap and Gloves Tool Board

Display Part No. TB4400



* custom display options available

PART NO.	DESCRIPTION	QTY
S20100	1" x 2' black single pack	6
S20101	1" x 4' red single pack	6
S20102	1" x 6' yellow single pack	6
G50200	Ⓢ Brown cotton jersey glove	6
S20103	1" x 8' green single pack	6
S20104	1" x 10' blue single pack	6
S20105	1" x 12' purple single pack	6
G50204	Leather palm low safety cuff glove	6

DISPLAY INCLUDES:
(1) 2' x 2' PEGBOARD, (9) PEG HOOKS, (1) HEADER, REORDER TAGS,
& PLANOGRAM

Socket Savers Tool Board

Display Part No. TB4500



* custom display options available

PART NO.	DESCRIPTION	QTY
J44050	1/2" socket saver	6
J44075	3/4" socket saver	6
J44100	1" socket saver	6
J44150	1-1/2" socket saver	6
J44200	2" socket saver	6
J44300	Ⓢ 3" socket saver	6
J44400	4" socket saver	6

DISPLAY INCLUDES:
(1) 2' x 2' PEGBOARD, (9) PEG HOOKS, (1) HEADER, REORDER TAGS,
& PLANOGRAM

Available Marketing Materials Include:

Reorder Tags



Pegboard Hooks



Spinner with Header



Planogram

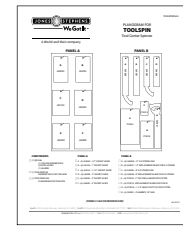

Complete Tool Spinner

Display Part No. TOOLSPIN



* custom display options available

PART NO.	DESCRIPTION	QTY
J44050	1/2" socket saver	6
J44100	1" socket saver	6
J44150	1-1/2" socket saver	6
J44200	2" socket saver	6
J44300	3" socket saver	6
J44400	4" socket saver	6
S49008	12" E-Z stroke pipe saw	6
S49007	12" E-Z stroke pipe saw replacement blade	6
S49005	8" E-Z stroke pipe saw	6
S49006	8" E-Z stroke pipe saw replacement blade	6
P70035	2" PVC one-handed pipe cutter	6
P70019	1-1/4" PVC pipe cutter replacement blade	6
P70018	1-1/4" PVC pipe cutter	6
S49001	18" plastic saw	6
P70052	Mini tubing cutter-1/8"-7/8" (uses P70055 repl. blade)	6
J40260	1/2" Copper tube cutter	6
J40261	3/4" Copper tube cutter	6
J40830	E-Z shear inside pipe cutter	6
J40831	E-Z shear replacement blades (2)	6
J40010	Faucet handle puller standard unit	6
J40262	1/4"-3/4" Ratcheting handle copper tube cutter	6
P70064	Enclosed feed tube cutter (1/8" x 1-3/16")	6
J45010	Universal drain wrench	6
J40080	Bar flaring tool	6
J40075	6" adjustable wrench	6
J40490	Dual kwik tite wrench	6
J40491	Angle compression stop wrench	6
T60060	No hub torque wrench	6
J45015	Stem and cartridge wrench	6
J40026	4-way P.O. plug wrench	6
J40019	Do All plumbers wrench	6
J40035	Lavatory nut removal tool	6
J40235	Quick drain wrench	6
T50001	3-N-1 tubing bender	6

DISPLAY INCLUDES:

(1) SPINNER DISPLAY, (34) PEG HOOKS, (1) HEADER, REORDER TAGS, & PLANOGRAM

Items marked with the Jones Stephens logo are "You Need It... We Got It" Items.

Big Wipes Display

Display Part No. B05030



Order 32 tubs and receive a free floor display.

PART NO.	DESCRIPTION
B05050	80 count tub (8 tubs per case)

DISPLAY INCLUDES: (1) HEADER, HOLDS 32 TUBS

Liquid Lightning Pro Drain Opener Display

Display Part No. LLPRODISP



PART NO.	DESCRIPTION
S95701	1 pint drain opener
S95793	1 quart drain opener

DISPLAY INCLUDES: (1) HEADER AND SHELF LABELS

Toilet Seat Stackout Display

Display Part No. STACKOUT



Order 50 seats* and receive a free stackout display.

*Seats must be same SKU.

Add your price to the header!

PART NO.	DESCRIPTION
STACKOUT	Holds 15 toilet seats

DISPLAY INCLUDES: (1) HEADER, HOLDS 15 TOILET SEATS

The Green Drain Display

Display Part No. Q00200



Order 24 or more Green Drains, any size, and receive a free counter display.

PART NO.	DESCRIPTION
Q00200	Green Drain counter display

DISPLAY INCLUDES: (1) HEADER AND 3" GREEN DRAIN

Numbers

2CanCaddy™302
3' Chrome Plated Brass Cover Tubes136
3-N-1
 Radiator Repair Tool282
 Tubing Bender305
4-Way
 Countersunk Plug Wrench282
 Key281
 Plug Wrench282
 P.O. Plug Wrench282
6-Way Countersunk Plug Wrench282
8-1/2" Pan Commercial Drains198
45° Flare Tube Fittings
 Female Flare Swivel137
 Flare Cap137
 Flare Elbow138
 Flare Plug137
 Flare Tee137
 Flare Union137
 Flare x FIP Coupling138
 Flare x MIP Branch Tee137
 Flare x MIP Half Union138
 Long Flare Nut137
 Short Flare Nut137
 Short Forged Flare Nut137

A

Access Fittings231
 Snap-in231
Access Panel
 Plastic95
 Snap-Ease95
 Spring Loaded95
Acid Brushes299
Acrylic Tub And Tile Caulk298
Actuator Unit
 for American Standard50
Adaper Bushing347
Adapter
 Black Plastic PEX144
 Brass Compression135
 Brass Hose Barb156
 Brass PEX142
 Cast DWV376
 Cast Iron Spigot, PVC DWV347
 Faucet77
 Faucet To Garden Hose77
 Female Adapter341
 Female, PVC DWV341
 Fitting C.O. Adapter, w/Plug341
 Forged Brass/Cast Pressure373
 Garden Hose, Twist To Lock146
 Hub Adapter for Cast Iron, PVC DWV347
 Insert, Galvanized161
 Insert Male Rope, Red Brass160
 Insert, Nylon158
 Insert, Poly.159
 Insert, Red Brass160
 Male, PVC DWV341
 No Hub Adapter347

Hub for Cast Iron, PVC DWV347
 Nylon157
 PlumBite145
 Press Fitting, Female371
 Press Fitting, Male371
 Soil Pipe376
 Spigot Adapter347
 Sweat Male72
 Twist To Lock146
 White Plastic PEX143
 Wrot DWV375
 Wrot Female, Copper363
 Wrot Male, Copper363

Adhesive, Plumber's Goop301

Aerator

Chicago Style Faucet76
 Counter Display76
 Non-Slotted .5 GPM76
 Non-Slotted Full Flow76
 Non-Slotted Reduced Flow76
 Six Pack Tubes For Counter Display76
 Slotted 2.2 GPM Flow76
 Slotted Full Flow76
 Slotted Reduced Flow76
 Snap Fitting77
 Spring-Flo77
 Swivel Spray77
 Vandal-Proof77

Air Cock164

Air Gap

Chrome Plated ABS69
 Cover5
 Decorative5
 Dishwasher Kit69
 Spacer69

Air Pump285

Air Valve167, 168

Air Vent, Plumb Aire69

Aluminum Bar for Waste and Overflow66

Anchor Drop-In Concrete129

Anchor Bolt Kit127, 395

Angle Air Valve167

Angle Compression Stop Wrench282

Angle Steam Vent168

Angle Stop23-25

Angle Valve, Plastic Push On147

Appliance Cord308

Aqua Seal Washer48

Area Drain227

Assembly

ABS Pop-Up68
 Brass Pop-up68
 Brass Pop-up, Replacement Parts68
 Chrome Plated ABS Pop-Up68
 Delta Style Spray73
 Lift & Lock Pop-Up68

B

Backflow Preventer168

Backflow Preventer/Sewer Stopper81

Backnut, Black Malleable353

Backwater Valve	241, 274	Stainless Steel Deep Cup	75, 337
Accessories		Stainless Steel Duo	75, 336
Flat Top Vent Cap	241	Stainless Steel Duo Post Style	336
Mushroom Vent Cap	241	Twist & Lock	74, 336
Plastic Over-Fitting Repair Fitting	241	Bastard File	296
PVC Coupling	241	Bathcock	
Spigot Adapter	241	for Clawfoot Tub	59
Cast Iron	274	Repair Kit	59
Extension Kit	240	Bath Drain	14-19, 61-66
Flapper with Gasket	240	Adapter Bushing	61
Ballcock		Bathroom Fan Vent Kit	102
And Flush Valve Repair Parts for Mansfield	50	Bathroom Faucet	33-34
Coupling Nut And Locknut	70	Bath Supplies, Offset	59
Mansfield Style	49	Bathtub Protector	61
Mansfield Style, With Float Rod	49	Bath Waste	
Repair Parts for American Standard	50	ABS Tubular	332
Repair Parts for Amerline/Hoov-R-Line	50	and Overflow Test Kit	66
Repair Parts for Coast	50	Cable Drive, ABS Tubular	332
Repair Parts for Fluidmaster	50	Cable Drive, PVC Tubular	332
Repair Parts for Kohler	50	Conversion Kit	66
Repair Parts for Mansfield	50	PVC Tubular	332
Ball Valve		Rough Brass	325
Brass Broiler Drain Valve	166	Rough-In, Schedule 40	66
Brass PEX	142	Rough-In, Schedule 40 With Test Kit	66
CPVC	167	Schedule 40 Kit	64, 65
Gas	165	Trim Kit	66
Gas Heater	165	Batteries	308-309, 407
Gas, Texas Pattern	165	Bell Reducer	140
PlumBite	145	Bell Trap	
PVC	167	Inside Caulk, Cast Iron	269
Bar		No Hub, Cast Iron	269
Digging/Tamping	290	Pittsburgh, Cast Iron	269
Gooseneck Wrecking	290	Spigot Outlet, Cast Iron	269
Utility Pry	290	Bibb Seat Tool Set	284
Bar Plug, Brass	75	Bit	
Bar Tap Faucet	4, 73	Holders	297
Basin		Phillips	297
And Tub Stopper	62	Blower, Industrial Utility	403
Cock Locknut	69	Blue Chalk Line Set	294
Crumb Cups	76	Boiler Gauge Dual Scale	116
Faucet	85, 86	Bolt	
Nut	70	Stove Bolt with Nut	126
Basket Strainer		Toggle Bolt	126
ABS Body And Post	75	Bore O-Ring	99
Chrome Plated ASAP	337	Box Cutter	402
Chrome Plated Brass Duo	75, 336	Boxes	
Decorative	3	20 Compartment Parts	302
Deep Cup	74, 336	Bin	131
Deep Junior Duo	75, 337	Cardboard Tub	131
Duo	74, 336	Plastic Tub	131
Flat Duplex	337	Shipping	131
Flat Top Grid	74, 336	Water Meter	130-131
Junior Duo	75, 337	Box Wrench	284
Locknuts And Washers	70	Bracket	
Quick Fit Stainless Steel	74, 337	Carrier	119
Replacement Strainer	74, 337	Extruded Hole Copper Plated	120
Shallow Cup Duo	74, 336	Extruded Notches Copper Plated	120
Snap Lock	74, 336	Flat Copper Plated	119
Snap N Lock Stainless Steel	337	Galvanized	119
Stainless Steel	75	Galvanized L	120

Galvanized Lockright	120	Caddies	
Galvanized Lockright Pipe-CPVC	120	1/2" & 3/4" Combo Nipple	302
Pipe	119	2CanCaddy	302
Water Closet-Copper Plated	120	Bucket	302
Brass Float Rod	49	Fitting Tote Tray	302
Brass Lift Wire	48	Plastic Nipple	302
Brass Lift Wire Guide	48	Steel Nipple Tray	302
Brass Needle Valves	162	Tool Totes	302
Brass Nipples	23	Utility Tote Tray	302
Brass Overflow Tube	49	Camouflage Strap With Hooks	305
Brass Plumb Bob	294	Cam Strap	305
Brass P.O. Plug Drain	68	Canvas Drop Cloth	396
Brass Saddle Clamp	162	Cap	
Brazing Rod	295	45° Flare Tube Fitting	137
Bronze Locknuts	150	Black Malleable	351
Bronze Pipe Fittings		Brass Compression	135
Bushing	151	Bronze	150
Cap	150	Chrome Plated	153
Coupling/ Reducer	151	Garden Hose, Nylon	157
Cross	151	Plastic Push On	147
Elbow	150	PlumBite	145
Extension Piece	151	Press Fitting	371
Locknut	150	PVC DWV	343
Plug	151	Space Heater Fitting	139
Tee	150	Test, Wrot DWV	375
Union	150	Wrot, Copper	365
Broom	395	Yellow Brass	140
Brush		Carbon Monoxide Alarm	398
4-N-1 Copper Tube Fitting	285	Cardboard Box	
Acid	299	Bin Boxes	131
Chip	299	Shipping Boxes	131
Copper Fitting	285	Tub Box	131
Female Copper Tube	285	Carrier Nuts and Washer Set	127
Long Handle Wire with Scraper	299	Cast Iron Commercial Drain Components	255
Paint And Dope	299	Caulk	
Shoe Handle Wire with Scraper	300	100% Silicone	297
Wire	300	Acrylic Tub And Tile	298
Brute® Containers	403	Fire Seal-136 Firestopping	299
Bubbler		Gun	298
Drinking Fountain	86	Hi-Temp Red Silicone	298
Drinking Fountain With Face Guard	86	Latex	298
Retrofit Kit	86	Siliconized Acrylic	298
Bucket Caddies	302	Caulking Tools	
Bushing		Broad Curve Nose	290
Adapter, For Bath Drain	61	Gun	298, 405
Brass Trap	59	Gun, Professional	298
Bronze	151	Inside	290
Chrome Plated	153	Outside	290
HEX, Black Malleable	351	Short Nose	290
HEX, Yellow Brass	141	Caution Tape	400
Twin Elbow And Face	59	Ceiling Flange	129
Wrot Flush, Copper	363, 366	Ceiling Plates, Floor and	80
Yellow Brass	141	Flexible	80
Bushing for Qwik Tees and Qwik Elbows	99	Center Outlet Tee	
Buttons		ABS	329
Faucet Index	78	Chrome Plated Brass	321
Single Handle Replacement	78	PVC	326
C		Center Outlet Waste	
Cable Drive Full Kit	19, 332	ABS	329
Cable Ties	304, 404	Chrome Plated Brass	322

PVC	326	No Hub, Cast Iron	260
Chalk Line Set	294	Over Pipe Fit	233
Check Valves	168	Pipe Fit	233
Chip Brush	299	Plain End Adjustable, Cast Iron	262
Chrome Plated Compression Fittings		Plain End, Cast Iron	261
3' Chrome Plated Brass Cover Tubes	136	Plumb Lock Adjustable, Cast Iron	261
Connector	136	Push-On Adjustable, Cast Iron	262
Elbow	136	Push-On, Cast Iron	260
Pilot Line Breakaway Nut	136	Countersunk Plug with Insert	230
Sweat Adapter	136	Cover	268
Union	136	Dome Cover Plate	268
Chrome Plated Nipples & Pipe Lengths	152	Fit-Flush	230
Chrome Plated Pipe Fittings		Fit-Flush Cleanout	230
Bushing	153	General Purpose	230
Cap	153	General Purpose Access Fitting	231
Coupling	152	Heavy Duty	229
Elbow	152	Heavy Duty Internal Pipe	229
Plug	153	Hub Fit	230
Reducer	152	Hub Fit with Countersunk Brass Plug	230
Tee	152	Hub/Fitting	229
Union	153	Inside Pipe Fit	228
Clamp		Internal Pipe	229
2-Hole Pipe	123	Internal with SS Cover	231
Full	122	Plug	
Half	122	Code Pattern	267
Insulating/Suspension	122	Extension Cover Set	267
Oetiker, PEX	143	for Extension Cover	267
Stainless Steel Repair Clamp	95	Heavy Pattern	266
Universal Beam Clamp	127	Lead Fit-All	266
Clamp-On Light	308, 406	New Orleans Code	266
Cleanout		Slotted	267
Cast DWV	376	Southern Code	266
Test Tee, PVC DWV	344	Sewer Relief Plug	231
Two-Way Tee, PVC DWV	345	Snap-in Access Fitting	231
Cleanout And Relief Valve Sewer	81	Test Tee with Plug	231
Cleanout Plugs		Trap Cover	268
Countersunk Cleanout Plugs	230	Cleanout Spuds	265
Drainable Cleanout Test Plug	230	Cleanout Tee	345
Raised Head Cleanout Plugs	230	Closet Bend	346
Cleanouts		Closet Bolts	
Commercial		Bulk Packed	52
Access Cover Adjustable, Cast Iron	263	Cap	53
Adjustable, Cast Iron	262	Component Parts	53
Adjustable Floor, Cast Iron	263	Custom Packed	52
Cleanout Ferrule, Cast Iron	261	Display Bucket	51
Components		Elite Packs	53
Gasket Connection Base, Cast Iron	265	Enduro	51
Metal Spud with Round Cover	236, 237, 265	Snap-Off	53
No Hub Base, Cast Iron	264	with Tinnerman Nuts	51
No Hub Cleanout Body, Cast Iron	264	Closet Flange	
Plain End Cleanout, Cast Iron	264	4-Way Offset	182
Plastic Spud with Cover and Square Top	265	Brass	246
Plastic Spud with Round Cover	236, 237, 265	Brass Four Way Offset	246
Plastic Spud with Square Cover	236, 237	Code Blue	245, 246
Replacement Covers	237	Extender	183
Spud with Cover, Cast Iron	265	Extension Kit	183
Heavy Duty, Cast Iron	263	Flange Support for Wood Floors	246
Hub Fit Base	232	Gapper Flange	246
Inside Pipe Fit	235	Gapper Repair Flange	184
No Hub Adjustable, Cast Iron	262	Inside Caulk	245

No Caulk	245	Connector	
No Hub	245	Brass Compression	135, 136
Offset	182, 246	Flexible Trap Drain	99, 335
Over Schedule 30 Pipe	182	Gas87
Plumbfit	182	Hose Grip Clothes Washer99
Repair Flange	246	Plastic Push On	147
Repair Ring	183, 246	Screw-On Wire	309
Ring	183	Twist To Lock	146
Two Finger Flange	245	Waste	71, 335
Urinal Flange	183	Contoured Shower Rod56
Closet Flange Extender	183	Conversion Kits	12-13, 66
Closet Flange Extension Kit	183-184	Cool Gel®	301
Closet Flange Repair Ring	246	Copper	
Closet Flush Elbow	324	4-N-1 Tube Fitting Brush	285
Closet Screws54	Cleaning Pads	306
Closet Spud47	Female Tube Brush	285
Friction Ring48	Fitting Brush	285
Washer47	Sizing Tool	291
Closet Wedge Shims51, 184	Swedge Tool	291
Flexible and Rigid Super Shims51	Copper Pipe Hangers - Bell & Milford Types	128
Cloth Inserted Plunger Disc	301	Copper Refill Tube48
Coast Ballcock Repair Parts50	Copper Sizing Tool	291
Combination Lock	408	Cored Square Head Plug	151
Commercial68	Coupling	
Grid Drain Without Overflow Holes68	45° Flare Tube	138
Handicap Drain With Elbow68	Banded, Black Malleable	351
Lav Drain68	Black Plastic PEX	144
Commercial Cleanouts, Adjustable	232	Brass PEX	142
Commercial Cleanouts, Residential and Light	229	Bronze	151
Commercial Drain Base	217-218	Chrome Plated	152
Heavy Duty Bases	218	Compression95
Heavy Duty Bases with Clamping Ring	218	CPVC Compression96
Hub Fit Bases	218	Crossover	364
Inside Pipe Fit Base	217	Drain, with Cap	373
Pipe Fit Base	217	Flexible Transition99
Slab Drain Bases	218	Forged Brass/Cast Pressure	373
Commercial Pipe/Hub Fit Adapter Drains	191	Heavy Duty No Hub	314
Commercial Sponges	396	Import Heavy Duty No Hub	315
Companion Flanges, Cast Brass		Import No Hub	315
125# w/A.S.M.E. Drilling	378	Insert, Galvanized	161
150# w/A.S.M.E. Drilling	378	Insert, Nylon	158
Compression Branch Tee	135	Insert, Poly	159
Compression Cap	135	Insert, Red Brass	160
Compression Connector	135	Medium Duty No Hub	314
Compression Coupling		Merchant, Black Malleable	359
Bronze95	No Hub	314
CPVC96	Plastic Push On	147
Malleable Iron95	PlumBite	145
PVC95	Press Fitting	370
Compression Elbow	136	PVC DWV	341
Compression Nut	135	PVC Expansion96
Compression Sleeve	135	Reducing, Banded Black Malleable	352
Compression Sleeve Puller	283	White Plastic PEX	143
Adapter	283	Wrot DWV	375
Compression Tee	135	Wrot Reducing, Copper	364
PVC96	Yellow Brass	140
Compression Union	135	Coverall, Disposable	399
Compression x Sweat Adapter	135	Coveralls, Replacement	221
Condensate Trap	240	Cover Plates	10, 81
Conduit Hangers	128	Cover, Toilet Tank51

Cover Tubes Brass Compression 136

Crimping Tools

 Pex Crimp Set 292

 Polybutylene 291

Crimp Ring

 Brass PEX 143

Crimp Set 292

Cross

 Banded, Black Malleable 353

 Bronze 151

Cross Handle Self Closing Valve 85

Crumb Cups, Sink and Basin 76

Curb Box Wrench 284

Curved Jaw Tongue & Groove Pliers 297

Cutting Oil 309

D

Deburring Tool 292

Delrin Compression Sleeve 135

Delta

 Faucet Index Buttons 78

 Replacement Handles 78

Dielectric Union

 Flanged 112

 Gasket and Insert 113

Digging/Tamping Bar 290

Dishwasher Connection

 ABS 330

 PVC 327

Dishwasher Kit 69

Dishwasher Repair 101

 Dishwasher Drain Connector 101

 Dishwasher Hose 101

Dishwasher Tailpiece

 ABS 330

 Chrome Plated Brass 324

 PVC 327

Dispenser, Soap and Lotion 4, 73

Disposable 304, 397

 Coverall 399

 Vinyl Gloves 304, 397

Disposal Assembly 3

Disposer Kit

 ABS 330

 Chrome Plated 324

 PVC 328

Disposer Kit w/13" Arm 328

Disposer Kit w/Adjustable Arm 328, 331

Dissolvable Pipe Plug 296

Diverter Spout

 7" Chrome Plated 59

 Add-A-Shower 58

 Chrome Plated 59, 60

 Chrome Plated Slip-On, With Polished Brass Knob 59

 Decorative 10-11

 Extension 60

 Slip-On 59

Do All Plumbers Wrench 284

Double Flange Extension

 ABS 330

 PVC 328

Double Flange Tailpiece Chrome Plated Brass 322

Double Offset Chrome Plated Brass 322

Double Offset Tailpiece PVC 328

Double Slip Fittings 71, 324, 328

 Chrome Plated 71, 324

 PVC 328

Drainable Cleanout Test Plug 230

Drain Cleaner 301

Drain Cock 164

Drain King 98

Drain Opener

 Drain King Mini Snake 301

 Liquid Lightning Pro 301, 426

Drains

 4-Way Area Drain 227

 Bell Trap 226

 Bell Trap with Hinged Lid 227

 Brass Inside Caulk Floor 259

 Bronze Shower 252

 Cast Iron Commercial Drains 250

 Caulk Cesspool with Recessed Grate, Cast Iron 270

 Commercial Components

 Coveralls 221

 Funnels 222

 Green Drain Waterless Trap Seal 222

 Heavy Duty Base 218

 Heavy Duty Base with Clamping Ring 218

 Hub Fit Base 218

 Inside Pipe Fit Base 217

 Metal Spud with Round Strainer 219-221

 Metal Spud with Square Strainer 220

 Pipe Fit Base 217

 Plastic Spud with 7" Square Top and Round Strainer 219-221

 Plastic Spud with Round Strainer 219-220

 Plastic Spud with Square Strainer 219-221

 Replacement Strainer for Metal Spud 221

 Rings 221

 Slab Drain Base 218

 Spud Extension 222

 Strainers 221

 Inside Pipe Fit 195, 196

 Over Pipe Fit 192, 193, 194

 Pipe Fit 191, 192

 Slab Drain with 8-1/2" Pan 205-211

 with 8-1/2" Pan 198-211

 with 10" Pan 212-216

 Components

 Gasket Connection Base, Cast Iron 256

 Heavy Duty Drain Base, Cast Iron 255

 IPS Drain Base, Code Blue 255

 No Caulk Mechanical Joint Drain Base, Code Blue 255

 No Caulk Mechanical Joint Slab Drain Base, Code Blue 256

 No Hub Base, Cast Iron 256

 No Hub Drain Base, Code Blue 255

 No Hub Slab Drain Base 256

 Push-On Drain Base, Code Blue 256

 Spud Extension, Cast Iron 256

 Spud with Round Strainer, Cast Iron 256

 Floor Drain with Trap 227

 General Purpose

Area Drain	227	Drop Ear Elbow	72
Area Drain, Cast Iron	258	Drop-In Concrete Anchor	129
Backwater Device	259	Dryer Repair	
Combination Drain Trap	259	Aluminum Ducting	
Des Moines Pattern Floor Drain	259	Flexible Aluminum	102
Floor Drain with Trap	259	Flexible Aluminum Foil	102
Gasket Connection Drain, Cast Iron	258	Proflex Aluminum Foil	102
Heavy Duty Traffic Floor Drain	224, 225	Aluminum Elbow and Pipe	102
Kentucky Drain, Cast Iron	258	Flexible Duct Connector Kit	102
Plastic Snap-In	225	Increaser/Decreaser	102
Snap-In	226	Vent	
Snap-In Strainer	226	Aluminum Hood	101
Socket Ring	226	Complete Dryer Vent Kit	102
St. Louis Drain, Cast Iron	259	Dryer Vent Hood	101
Urinal Drain Flange Kit	259	Dryer Vent Hose	102
with Long Body	223	Dryer Vent Kit w/Louvered Hood	102
Inside Caulk Floor/Shower, Heavy Duty	252, 253	Indoor Dryer Vent Kit	102
Inside Pipe Fit	228	Louvered Dryer Vent Hood	101
IPS Floor, Code Blue	253, 254	Metal Clamp for Dryer Vent	102
IPS Floor Drain, Code Blue	251	Dual Flush Toilet Kit	50
No Caulk Floor Drain, Code Blue	250	Ducting	
No Caulk Mechanical Joint Cesspool, Code Blue	270	Flexible Aluminum	102
No Caulk Mechanical Joint Floor, Code Blue	252, 254	Proflex Aluminum Foil	102
No Caulk Slab Mechanical Joint, Code Blue	250	Duct Straps	304
No Hub Floor, Code Blue	253, 254	Duo Basket Strainer	3-4, 74-75
No Hub Floor Drain, Code Blue	251	Deep Junior	4, 75, 337
No Hub Floor/Shower, Heavy Duty	252, 253	Junior	4, 75, 337
No Hub Slab, Code Blue	253, 254	Duracell® Alkaline Batteries	309
No Hub Slab Drain, Code Blue	251	Dust Mask	399
Non-Adjustable, Code Blue	248	E	
Push-On Floor, Code Blue	251, 254	Ear Plugs, Ready Fit Corded	399
Rainleader Cesspool, Cast Iron	270	Earthquake Strap	123
Replacement Strainer, Code Blue	248	Elbow	
Roman Tub, Code Blue	247	45° Flare Tube	138
Roman Tub Replacement Strainer, Code Blue	248	Banded, Black Malleable	353
Roof Drain, Code Blue	272	Black Plastic PEX	144
Roof Drains, Accessories for	242	Brass Compression	136
Roof Drain with Cast Iron Dome	242, 272	Brass Hose Barb	156
Roof Drain with Plastic Dome	242	Brass PEX	142
Round Slop Sink, Hydrant Cesspool, Cast Iron	270	Bronze	150
Square Cesspool Grate, Cast Iron	270	Cast DWV	376
Square Hydrant Cesspool, Cast Iron	270	Chrome Plated	152
Utility	226	Double, PVC DWV	343
Drain, Three Prong Protector	76	Drop Ear	72
Dresser Coupling	95, 96	Drop Ear, Brass PEX	143
Drill Bits		Flanged Sink, Forged Brass/Cast Pressure	373
Carbide Tipped Masonry	292	Forged Brass/Cast Pressure	373
Dual Auger Wood	293	Hi-Ear, Forged Brass/Cast Pressure	373
Flat "Paddle" Wood	293	Insert, Nylon	158
Masonry	292	Insert, Poly	159
Straight Shank	293	Insert, Red Brass	160
Wood Spade	293	Nylon	157
Drinking Fountain		PlumBite	145
Bubbler and Cartridge	86	Press Fitting	370
Bubbler With Face Guard	86	P-Trap, PVC DWV	346
Cross Handle Self Closing Valve	85	PVC DWV	341
Retrofit Bubbler Kit	86	Qwik	98
Self-Closing	86	Reducing, Banded Black Malleable	352
Drop Cloth	396	Space Heater Fitting	139
Drop Cord Light	308	Twist To Lock	146

Union, Twist To Lock	146	Acrylic Handle	32
White Plastic PEX	143	Commercial Style	31
Wrot, Copper	365	Hi-Arc	31
Wrot DWV	375	Pull-Out	31
Yellow Brass	140	Single Handle	31
Eljer Replacement Handles	78	Spring Neck	31
Enclosed Feed Tube Cutter	287	Teapot Style	31
End Outlet Tee	321, 326, 329	Teapot Style Pull-Out	31
End Outlet Waste	321, 329	Two Handle	31-32
ABS	329	Two-Handle Gooseneck	31, 32
Chrome Plated Brass	321	Laundry Tray	36, 85
PVC	326	Long Reach Bar Tap	73
Engineers Hammer	290	Replacement Handle	37, 77-79
Escutcheons		Seat Repair Kit	282
Plastic Shallow Flange	80	Seat Wrench	282
Poly Bagged	79	Seat Wrench For Recessed Seats	282
Sure Grip	79	Service Sink	86
Expansion Coupling, PVC	96	Shower	36
Expansion Joint	347	Specialty	
Expansion Tank	112	Laundry	36
Extension Cord	308, 405-406	Pull-Out Utility	36
Extension Hose	98	Stem and Seats	37, 79
Extension Piece		Tub and Shower	
Black Malleable	351	Acrylic Handle	34-36
Bronze	151	Heavy Pattern	35
Extension Tube	7, 323, 325, 328, 330	Single Handle	34
ABS	330, 331	Three Handle	34-35
Chrome Plated Brass	323	Two Handle	35
PVC	327, 328	Wall Mount Sink	85
Rough Brass	325	Faucet And Valve Grease, Plumber's	301
Extract-a-Drain Tub Drain Removal Tool	283	Faucet Handle Pullers	283
E-Z		E-ZEE Pull Deluxe	283
Light	305	Faucet Hole Cover	4, 5, 73
Reach	305	Faucet Seat	72
E-Z Anchor/Self-Drilling Wall Board	126	Faucet Seat Kit	72
E-Z Shear Inside Pipe Cutter	286	Faucet To Garden Hose Adapters	77
F		Female Copper Tube Brush	285
Face Bushing	59, 141	Female Flare Swivel	137
Face Plate Gasket	61	F.H.A. Strap	118, 119
Fan		Galvanized Steel	118
Cradle	403	F.H.A. Tub Hanger	123
Industrial Utility Blower	403	Files	296
Pedestal	403	Fill Valve	395
Faucet		Integral Float	49, 395
Adapters	77	Korky	49
Bar Tap	73	Fire Seal-136 Firestopping Caulk	299
Basin	85	Firestop 814+ Intumescent Firestopping Sealant	298
Basin, Self-Closing and Shower Valve	86	Fit-All	
Bathroom		Basket Strainer	74, 337
Acrylic Handle	33-34	Drain Hose	101
Handicap	34	Flapper	46
High-Spout	33	Kitchen Hose And Spray	73
Single Handle	33	Lift Wire	48
Teapot	33	Plug	266
Two Handle	33-34, 37, 78, 79	Radiator Valve Handle	168
Wide-Spread	33	Replacement Handles	77
Ceramic Cartridge	37, 79	Stopper	62
Gooseneck Bar	36	Tank to Bowl Gasket	55
Index Buttons	78	Toilet Tank Cover	51
Kitchen		Fitting Cleanout	376

Fitting Cleanout, Flush	376	Three-Quarters Top Grate for Floor Sinks	239
Fitting Plug	366	Flow Restrictor	58
Fitting Reducer	375	Flush Bushing, PVC DWV	341
Fittings, Double Slip	71, 324, 328	Flush Fitting Cleanout	376
Flange Cast Brass	378	Flush Valve	
Flange Connection Gasket	171	Douglas	49
Flanged Tailpiece		Dual Flush Kit	50
ABS	331	for American Standard	50
PVC	328	Mansfield #210	49
Rough Brass	325	Pipe Support	69
Flange Support	246	Repair Parts for Mansfield	50
Flapper		Shank Washer	48
2 Way, with Separate Trunion	46	Flux Paste	295
Blue Vinyl	46	Flux-Rite 90® Flux	295
Jumbo ToTo Style	46	Foundation and Roof Coating	124
Kohler	46	Freeze Fix Pipe Jackets	296
Korky	46, 47	Friction Ring	
Flare Elbow	138	Brass	71
Flare Tees	137	Closet Spud	48
Flare Union	137	Full Clamp	122
Flare x FIP Coupling	138	Funnels	257
Flare x MIP Branch Tee	137	Funnels, for Shower/Floor Drains	222
Flare x MIP Half Union	138	G	
Flaring Tools	292	Galvanized Insert Fittings	161
Swing Release	292	Insert Adapter	161
Flashlight	306-307, 406-407	Insert Coupling	161
Flat Duplex Strainer	75	Gapper Flange	184, 246
Flat Top Vent Cap	241	Garbage Disposal	
Flexible Discharge Hose	125	Cords	309
Flexible Drain Trap	99	Splash Guard	76
Flexible Floor And Ceiling Plates	23	Stopper	75
Flexible PVC Saddle Fitting	99	Wiring Kit	309
Flexible Transition Coupling	99	Wrench	281
Flexible Trap Drain Connector	99, 335	Garden Hose Fittings	
Flint Striker	294	Adpater	154
Three Flint Friction Lighter	294	Cap	155
Flip-It	62	Evaporation Cooler Drain	155
Flip-It Conversion Kit	14, 62	Filter Washer	155
Flip-It Tub Stopper	14, 62	Hose Barb	155
Float Ball	46	Shut Off	155
Floating Lantern & Battery	306	Swivel	155
Float Rod	49	Washer	155
Floor & Ceiling Plates		WYE	155
Flexible Plastic	80	Garden Hoses	400
Heavy 21 Gauge	80	Gas Ball Valve	165-166
Light 24 Gauge	80	Gas Burners	
Floor Drain	185-187, 227-250, 254	2-Way Combo Log Lighter Valve	277
with Trap	227	Log Lighter Burner Bar	276
Floor Flange, Black Malleable	353	Log Lighter Keys and Accessories	277
Floor Sink		Log Lighter Valves	276
Aluminum Bottom Dome For Cast Iron Sink	271	Log Lighter Valve with T-Burner	277
Aluminum Dome Strainers for Floor Sinks	239	Rectangular Burner	276
Complete PVC Floor Sink Kits	238	Round Burner	276
Complete PVC Floor Sink Kits-Pipe Fit	239	" T " Burner Bar	276
Flat Aluminum Bottom Strainer for Floor Sinks	239	Two Leg Burner	276
Full Top Grate for Floor Sinks	239	Gas Connectors	
Half Top Grate for Floor Sinks	239	Black Coated	92
Plumlock Porcelain	271	Yellow Coated	87-88, 90-92
Porcelain Coated	271	Uncoated	87-89
Round Slop Sink	238	Gas Heater Valves	165

Gasket

Asbestos- Free Full Face Gasket 171
 Asbestos- Free Ring Gasket 171
 Circulator Flange Gasket Pair 172
 Dual Tite 313
 Dual Tite Buna N "Nitrile" 313
 Face Plate 61
 Kit 171-172
 Materials 172
 Multi-Tite 313
 Radiant Seal Sponge Rubber Closet Gasket 55
 Red Rubber Full Face Gasket 171
 Red Rubber Ring Gasket 171
 Shoe 61
 Sponge Closet 48
 Tank to Bowl 55
 Wax 55

Gasket Kit 171-172

Gasket Material 172

Gas Line Marking Labels 305

Gas Range Fittings 139

Gas Shut-Off Valve 163

Gate Valve Key 291

Gear Clamps

"68" Series Stainless 170
 Full Size 170
 Micro Size 169
 Replacement Clamp For Flexible Coupling 169
 Stainless Steel 170

General Purpose Drain 223-227

Glasses, Safety 399

Hellraiser 399
 Nemesis 399
 Visio 399

Gloves

All Purpose Latex Palm/Mesh Back 303, 397
 Anti-Vibration Synthetic Leather 302
 Blue Nitrile 303, 397
 Brown Jersey 303, 398
 Disposable Blue Latex 303, 397
 Drivers' Style Leather 304, 398
 Economy Brown Jersey 303, 398
 Industrial Rubber 303, 398
 Leather Palm Work 303, 398
 Nitrile 303, 398
 Polyester Nitrile Dipped Palm 303, 398
 Vinyl 304, 397
 Vinyl Disposable 304, 397
 White Canvas Work 303, 398
 White Cotton with Grippers 303, 398

Goggles, Clear Safety 399

Gooseneck Bar Faucet 36

Grab Bar

Fastening System 67
 With Concealed Snap-On Flange 67
 With Exposed Flange 67

Grab-It Tool 306

Gradient Level, Top Grade 306

Green Drain Waterless Trap Seal 222, 395

Grid Drain

Commercial Lav 68, 333
 Handicap Style Lav 68, 333

Grid Strainer 336

Griplock Tongue & Groove Water Pump Pliers 296

H

Hacksaw 288

Close Quarters 288

Hair Strainer 75

Half Clamp 122

Handicap 299

Handi-Plug 298

Hand Torch 295

Hand Wipes 397

Hanger

Adjustable Lavatory 74
 Clevis 128
 Conduit 128
 Iron 123
 Lavatory 74
 Mop, for Service Sink 86
 Pipe 121, 128
 Sink 74
 Tape 123

Hat, Safety 399

Head-Lite, Sportsman L.E.D. 307, 407

Heater

Ceramic 403
 Forced Air Propane 402
 Shop 403

HEX Bushing 141, 151, 351

HEX Head Plug 140

HEX Nipple 141

Hex Nut 127

Hinged Split Ring 129

Hi-Temp Red Silicone Caulk 298

Hornet & Wasp Spray 304, 401

Hose

Dryer Vent 102
 Extension 98
 for Service Sink 126
 Garden 400
 High Pressure with Fitting 285

Hose and Spray

Decorative 4
 Kitchen (Fit All) 73
 Rinse-Quik 73

Hose Barb

Adapter 156
 Elbow 156
 Splicers 156
 Swivel 156
 Tee 156

Hose Barb Fittings 156

Hose Bibb 169

Hose Bracket for Service Sink 126

Hose Faucet Anchor 169

Hose Grip Clothes Washer Connector 99

Hose Nozzle 400

Hub Fit Adapter Drains 191

Hub Fit Commercial Drain 197

Hydrostatic Pressure Pump	284	Commercial	68
RP 30	285	Decorative	6
I		Handicap Style	68
Icemaker Boxes with Valves	100	Lav Supply Tubes	26
Icemaker Or Humidifier Kit	162	Lead Ingot	124
Inside Pipe Fit Cleanout	228	Lead Joint Runners	306
Inside Pipe Fit Commercial Drain	195-196	Lead Melting Pot	124
Inside Pipe Fit Drain	228	Lead Pouring Ladle	124
Instant Sealant	126	Lead Wool	124
Insulating/Suspension Clamp	122	Leak Alert Water Detector	309
Insulation Protective Coating	112	Leak Detector	301
Intergral Float Fill Valve	49	Leak Detector, Visu-Glow	301
J		Level	
J-Bend		Plastic Magnetic	306
ABS	330	Top Grade Gradient	306
Chrome Plated Brass	320	Torpedo	306, 404
Flexible	99	LevelBest Drainage and Cleanout System	189-190
PVC	327	Adapter	189
with Cleanout	321	Adapter with Spud and Cleanout	189
J-Hook	121-122	Adapter with Spud and Strainer	189
Drive	121	Complete Heavy Duty Drain System	190
For CTS Water System	121	Complete Heavy Duty Slab Drain System	190
For Drain Pipe System	122	Complete Hub Fit Cleanout System	190
Joint Compound		Complete Hub Fit Drain System	190
Slic-tite Heavy Duty Thread Sealing	301	Complete Pipe Fit Cleanout System	190
Spray Weld	300	Complete Pipe Fit Drain System	190
Whitlam "Blue Magic" Pipe	300	Drain Base with Adapter	189
Whitlam Seal Unyte	300	Lift Wire	
Whitlam "Select Unyte" Teflon Pipe	301	Brass	48
Joint Runner, Lead	306	Brass Guide	48
Jumbo Shower Bar Flange	56	Liquid Lightning Pro Drain Opener	301, 426
K		Lock	408
Key Safe	408	Locknut	
Kitchen Faucet	31-32	Ballcock Coupling Nut And	70
Ceramic Cartridge	37	Basin Cock	69
Replacement Handle	37	Basket Strainer, And Washers	70
Kitchen Hose and Spray	73	Black Malleable	353
Knee Pads	399	Bronze	150
Knives		Yellow Brass	141
Deluxe Autolock Snap	288	Long Flare Nut	137
Snap	288	Long Nipple	141
Utility	288, 402	Loop and Lock	408
Korky	46-47	Lotion And Soap Dispenser	4
L		Lubricant	
LACO		Cutting Oil	309
Cool Gel®	301	WD-40®	305, 405
Flux Paste	295	Lugs, Sink	73
Flux-Rite 90® Flux	295	M	
Marking Products	299	Magnetic	
Slic-tite® Heavy Duty Thread Sealing Compound	301	Plastic Level	306
Slic-tite® High Density Thread Sealants	103	Power Nut Setters	297
Visu-Glow Leak Detector	301	Torpedo Level	306, 404
Latex Caulk	298	Manhole Cover Lifter	290
Laundry Tray Faucet	36	Mansfield Style	
Lavatory		Ballcock	49
Adjustable Hanger	74	Ballcock and Flush Valve Repair Parts	50
Hangers	74	Ballcock With Float Rod	49
Legs	73	Flush Valve	49
Nut Removal Tool	282	MAPP Cylinders	294
Lav Drain		Markers	299

Marking Labels, Gas Line305
Marking Paint299
Marvel Adapter72, 335
Marvel Ring335
Mega Torque Wrench314
Merchant Couplings359
Metal Stud Insulator120
Metal Stud Pipe Insulator123
Meter Key291
Milwaukee Style Trap320
Mixer Hose101
Mixet Replacement Handles78
Moen
 Replacement Handles78
 Single Handle Replacement Buttons78
Mop Hanger for Service Sink126
Moss Bay Repair Flange246
Mushroom Vent Cap241
N
Nail Puller290
Nails
 Copper Clad Nail122
 Copper Coated J-Nails122
Needle Valve for Pressure Gauge116
Nipple
 Black356-357
 Chrome Plated152
 Galvanized356-357
 Red Brass148-149
 Yellow Brass141
Nipple Caddy
 Combo302
 Plastic302
 Steel Tray302
Nipple Extractor
 And Screw Extractors292
 Internal Pipe292
 Set292
No Hub Torque Wrench314
“No Pinch” Pipe Wrench Pliers296
Nut
 45° Flare Tube Fitting137
 Basin70
 Brass Compression135
 Carrier Nuts and Washer Set127
 Chrome Plated Brass Slip Joint70
 Chrome Plated Die Cast Zinc Slip Joint334
 Die Cast Zinc Slip Joint70
 Hex Nut127
 Lavatory Supply70
 Lock, Yellow Brass141
 Plastic Slip Joint70, 334
 Rod Coupling129
 Rough Brass Slip Joint70, 334
 Setters297
 Space Heater Fitting139
 Split70
 Stove Bolt with Nut126
Nut Driver297
Nut Setters, Magnetic Power297

Nylon Fittings
 Adapter157
 Elbow157
 Garden Hose Cap157
 Hose Barb Adapter157
 Insert Adapter158
 Insert Combination Elbow158
 Insert Coupling158
 Insert Elbow158
 Insert Tee158
 Splicer157
 Tee157
Nylon Garden Hose Fittings157
Nylon Hose Barb Fittings157
Nylon Insert Adapters158
Nylon Line Reel123, 294
O
Oakum124
Oetiker PEX Stainless Steel Clamp143
Offset Bath Supplies7, 59
Offset Tank to Bowl Bolts54
Oil, Cutting309
One-Hole Schedule 40 Half Kit15-16, 64-66
O-Ring
 Bore99
 Kit And Pick72
Outlet Tee
 ABS329
 Chrome Plated321
 PVC326
Overflow Plate12-13, 61
Overflow Tube49
Over Pipe Fit Commercial Drain192-195
P
Packing
 Candle Wick123
 Graphite124
Padlock408
Pads
 Copper Cleaning306
 Knee399
Paint
 5 in 1 Painters Tool300
 Marking, Industrial Choice Precision-Line Inverted299
 Spotter Hand-Help Wand299
Paint Holder299
Pantry Faucet73
Peerless
 Faucet Index Buttons78
 Replacement Handles78
Pencil Torch295
“Perfect Low Profile” Shower Drain187
Perforated Hanger Iron123
PEX Fittings
 Adapter142-144
 Ball Valve142
 Coupling142-144
 Crimp Ring143
 Elbow142-144
 Plug142-144

Tee	142-144	Pipe Taps	293
Phillips Bits	297	Pipe Wrap Tape	103
Pick Mattock	290	Pipe Wrench	
Pigtail Syphon	115	Aluminum	284
Pilot Line Breakaway Nut	136	Heavy Duty	284
Pipe		Plastic Access Panel	95
Lubricant	313	Plastic Drop Cloth	396
Readycut, Black Malleable	358	Plastic Flow Restrictor	58
Pipe Bracket		Plastic Hanger Tape	123
Carrier	119	Plastic Magnetic Level	306
Extruded Hole Copper Plated	120	Plastic Push On Fittings	147
Extruded Notches Copper Plated	120	Pliers	
Flat Copper Plated	119	Curved Jaw Tongue & Groove	297
For Water Closet-Copper Clad	120	Pipe Wrench, "No Pinch"	296
Galvanized	119	Slip Jaw	296
Galvanized L	120	Smooth Jaw	296
Galvanized Lockright	120	Smooth Jaw Tongue & Groove	297
Galvanized Lockright-CPVC	120	Tongue & Groove	296
Pipe Cutter		Water Pump	296
Heavy Duty PVC	286	Water Pump, Griplock Tongue & Groove	296
Inside	286	Plug	
Professional PVC	286	45° Flare Tube Fitting	137
PVC	286	Black Plastic PEX	144
PVC One-Handed	286	Brass Bar	75
Pipe Hanger		Brass PEX	142
Conduit Hanger	128	Bronze	151
Copper - Bell & Milford Types	128	Chrome Plated	153
Schedule 40	121	Fitting C.O. Adapter with Plug	341
Pipe Hook	121	Handi-	298
"Copper Boy"	121	Plastic Push On	147
Plastic Coated	121	Square Head, Black Malleable	355
Pipe Insulation		Sure Sweat Dissolvable Pipe Plug	296
Insulation Protective Coating	112	Tray	75, 335
Insulation Tape	112	White Plastic PEX	143
Poly		Wrot, Copper	366
Double Stick Pipe Insulation	111	Yellow Brass	140
Self-Sealing	111	Plug Drain, Brass P.O.	68
Semi-Slit Pipe Insulation	111	Plug, Fitting	366
Tees and Elbows	112	Plumb Aire Air Vent	69
Rubber		Plumb Bob, Brass	294
Double Stick Rubber Pipe Insulation	108	Plumber's	
Seamless Rubber Pipe Insulation	107	Cotton Handy Towels	396
Pipe Insulator	122	Epoxy Putty	301
Metal Stud	123	Faucet And Valve Grease	301
Pipe Jacket, Freeze Fix	296	Goop Adhesive	301
Pipe Joint Compound		Putty	301
Whitlam "Blue Magic"	300	Plumbing Connectors	
Whitlam "Select Unyte" Teflon	301	Braided Nylon	83
Pipe Lubricant	313	Flexible Stainless Steel	82-83
Pipe Nipple Black	356-357	PlumbBite Push On Fittings	145
Pipe Nipple Extractor	292	Plumbjet	98
Pipe Nipples		Plumb Kit	61
Black Malleable	356-357	Plunger	
Chrome Plated	152	Force Cup	98, 395
Galvanized Malleable	356-357	Professional Force Cup Display	98, 395
Red Brass	148-149	Plunge Right	67
Pipe Plugs, Sure Sweat Dissolvable	296	Pointing Trowel	290
Pipe Sleeving	104	Poly Fittings	
Pipe Strap	122	Combination Elbow	159
Pipe Support, Flush Valve	69	Insert Adapter	159

Insert Coupling	159	PVC with Solvent Weld Marvel	326
Insert Elbow	159	Rough Brass	325
Insert Reducer	159	Rough Brass P-Trap	325
Insert Tee	159	Suction Line	366
Poly Insert Fittings	159	U-Bend	346
Poly Sheeting	309	with ABS Adapter	320
P.O. Plug Lav Drain	333	With Cleanout	377
Pop-Up Assembly		with PVC Adapter	320
ABS	68, 333	with Solvent Weld Joint	346
Brass	68	with Sweat Connection	320
Chrome Plated ABS	68, 333	with Union	345
Chrome Plated Brass	333	Wrot Suction Line, Copper	366
Polished Brass	333	Pump	
Replacement Parts	68	Air	285
Portable Halogen Work Light	307	Economy Air	285
Press Fittings	370-372	Hydrostatic Pressure	284
Pressure Gauges		RP 30 Hydrostatic Test	285
Gas	114-115	Water	285
Gas Test Assembly	115-116	Push On Fittings	
Gas Test Gauge	115	Plastic	
Gas Testing Equipment	114	Angle Valve	147
Liquid Filled	114	Cap	147
Needle Valve	116	Connector	147
Pressure Gauge	115	Coupling	147
Sillcock/Water or Gas Test Gauge Assembly	115	Elbow	147
Test Gauge Assembly	115	Needle Valve	147
Tridicator	116	Plug	147
Vacuum Gauge	116	Straight Valve	147
Water Test Gauge	115	Tee	147
Pressure Snubber	116	Union	147
Primer for Pipe Wrap Tape	103	PlumBite	
Propane Cylinders	294	Adapter	145
Protective Blanket	295	Ball Valve	145
Protector, Three Prong Drain	76	Cap	145
Provent	69	Coupling	145
PTFE Thread Seal Tape	103	Elbow	145
P-Trap		Removal Tool	145
ABS	329	Supply Stop	145
ABS, Chrome Plated	331	Tee	145
ABS Plastic	329	Twist To Lock	
Boston Style	320	Connector	146
Brass Tubular	6	Coupling	146
Cast DWV	377	Elbow	146
Chrome Plated	320	Tube End Stop	146
Chrome Plated ABS	329, 331	Union	146
Chrome Plated Boston Style	320	Putty	
Chrome Plated Brass	319	Plumber's	301
Chrome Plated Milwaukee Style	320	Plumber's Epoxy	301
Chrome Plated PVC	69	Putty Knife	300
Chrome Plated Sink Trap with PVC Adapter	320	PVC Shower Pan Liner Cement	57
Chrome Plated Sink Trap with Sweat Connection	320	Q	
Commercial	69	Qwik Elbow	98
Commercial, with Cleanout	69	Qwik Tee	98
Elbow	346	R	
LA Pattern with Union	345	Radiant Seal Sponge Rubber Closet Gasket	55
Milwaukee Style	320	Radiator Accessories	167, 168
P-Trap w/Adapter	329	Radiator Angle Air Valve	168
PVC	326	Radiator Angle Valve	167
PVC, Chrome Plated	329	Radiator Coin Key Air Valve And Key	167
PVC DWV	345	Radiator Spud Wrench	281

Radiator Straight Air Valve	168	Valley	78
Radiator Valve Handle	168	Replacement Strainers	21, 248, 252
Rags, Box of	396	For Roman Tub Drains	21, 248
Ratchet Strap	305	Regular Strainers	21, 248
Tie Down	305	Restrictor	58
With Step Release J-Hooks	305	Rings, for Drain and Cleanout Spuds	221
Rayovac		Rinse-Quik Hose and Spray	73
Batteries	308, 407	Riser Clamp	129
Heavy Duty Industrial	308, 407	Rod	
Floating Lantern & Battery	306, 407	Probing	291
Industrial Flashlights	307, 407	Steel Probing	291
Readycut Pipe	358	Steel Probing, with Ball Point	291
Ready Fit Corded Ear Plugs	399	Rod Coupling Nut	129
Red Brass Insert Fittings		Roman Tub Drains	247
Insert Adapter	160	Roof Drains	
Insert Coupling	160	Accessories for Roof Drains	242
Insert Elbow	160	Roof Drains w/Cast Iron Dome	242
Insert Male Rope Adapter	160	Roof Drains w/Plastic Dome	242
Insert Reducer	160	Roof Flashing	
Insert Tee	160	All Neoprene	125
Insert x MIP 90° Elbow	160	Aluminum	125
Insert x Sweat Adapters	160	Galvanized	125
Red Brass Pipe Nipples	148-149	Lead	125
Red Rubber Sheet Packing/Gasket Material	172	Neo-poly	125
Reducer		Roofite	125
Bell, Yellow Brass	140	Roofite Hi-Heat Silicone	125
Bronze	151	Rosettes	69
Chrome Plated	152	Rough Brass Tubular	325
Insert, Poly	159	Rough-In Kit	66
Insert, Red Brass	160	Rubber Hose	400
Press Fitting, Copper	372	Rubbermaid® Commercial Products	403-404
Wrot DWV	375	Rubber Sheet	172
Wrot Fitting, Copper	367	Running Trap	275
Refill Tube	48	Run-Off Tube	114
Relief Valve, Cleanout and Sewer	81	S	
Removal Tool		Saddle Tees and Kits	231
Extract-a-Drain Tub Drain	283	Saddle Tee, Tapped	275
Lavatory Nut	282	Safety	
PlumBite	145	Carbon Monoxide Alarm	398
Repair Clamp Stainless Steel	95	Disposable Coverall	399
Repair Cover Plates	81	Dust Mask	399
Repair Fitting	241	Glasses	399
Repair Flange	246	Hellraiser	399
Repair Plate	275	Nemesis	399
Repair Plug	96	Visio	399
Repair Trap		Goggles	399
ABS	330	Goggles, Clear	399
Chrome Plated Brass	321	Hat	399
PVC	327	Hornet and Wasp Spray	304, 401
Replacement Clamp For Flexible Couplings	169	Knee Pads	399
Replacement Handles		Leak Alert Water Detector	309
Aqualine	78	Outlet	308
Delta	78	Protective Shoe Covers	398
Eljer	78	Ready Fit Corded Ear Plugs	399
Fit-All	77	Shubee Shoe Covers	398
Mixet	78	Safety Outlet	308
Moen	78	Sand Cloth	104
Peerless	78	Flexible Open Mesh	104
Sears	78	Open Mesh	104
Stanadyne	78	Waterproof Aluminum Oxide	104

Water Resistant 104

Sanitary Tee 344

Satin Brass Air Cock 164

Saws

 Cable 288

 Close Quarters Hacksaw 288

 Drywall 287

 Hardwood 250 Speed Handsaw 287

 PlumBest Plastic 287

 T-Handle Cable 288

Scraper 300

Screw and Nipple Extractors 292

Screwdrivers 297

 4 in 1 297

 6 in 1 297

Screw-On Wire Connector 309

Screws

 Anchor Bolt Kit 127

 Drill Point Tech Screw 127

 E-Z Anchor/Self-Drilling Wall Board 126

 Flat Phillips Head Brass Wood Screw 126

 Hex Head Lag Screw 126

 Hex Head Tapping Screw 127

 Hollow Wall Anchor Kit 127

 Phillips Head Wood Screw 126

Screws, Solid Brass Bibb Assortment Kit 72

Sealant

 100% Silicone Tub and Tile 297

 Firestop 814+ Intumescent Firestopping 298

 Instant 126

 Silicone Tub And Tile 297

 Slic-tite High Density Thread 103

Sears Replacement Handles 78

Seat Disc 45

Seat Disc and Tank Ball for American Standard 46

Service Sink

 Faucet 271

 Hose and Bracket 271

 Mop Hanger 271

 Mop Service Basin 271

 Trap Standard 271

Service Sink Repair

 Hose and Hose Bracket 126

 Mop Hanger 126

Sewage Ejector/Sump Pump Check Valve 124

Sewer Popper 80

Sewer Relief Plugs 231

Sewer Relief Valve and Cleanout 81

Sewer Stopper/Backflow Preventer 81

Sheeting, Poly 309

Sheet Packing 172

Shims

 Closet Wedge 51, 184

 Flexible 51, 184

 Rigid 51, 184

Shoe Covers

 Protective 398

 Shubee 398

Shoe Gasket 61

Short Flare Nut 137

Shovel

 Economy 289, 401

 Fiberglass Handle 289, 401

 Long Handle Round Point Fiberglass 289

 Premium Grade Wood Handle 289

 Snow 289, 401

 Specialty 289

Shower, Add-A-

 Accessories 58

 Code Pattern 58

 Complete Unit 58

 Diverter Spout & Riser 58

 D-Style 58

 Less Oval Shower Rod 58

Shower Arm

 And Kits 57

 Decorative 8-9

 Flange 57

 Heavy Adjustable 57

 Plastic 57

 with Flange and Set Screw 57

Shower Arm Flange, Decorative 10

Shower Curtain Pin 57

Shower Diverter Valve 7, 59

Shower Elbow, Brass For Fiberglass Shower Stall 59

Shower Head

 Adjustable Massage 57

 Adjustable Plastic 57

 Brass 56

 Brass Aerating Water Saver 57

 Decorative 7-8

 Deluxe 56

 Die Cast 56

 Octagonal 57

 Plastic 56

 Vandal Proof 57

Shower Pan Liner 57

Shower Pan Liner Cement 57

Shower Rod

 Adjustable Aluminum 56

 Aluminum 56

 Aluminum, with Holders 56

 Contoured 56

 Decorative 10

Shower Rod Flange 7, 56

Shower, Utility 59

Shower Valve 86

Shut-Off Valve, Gas 163

Shut-Off Valves 163

Silicone

 Caulk 297, 405

 Tub And Tile Sealant 297

Siliconized Acrylic Caulk 298

Sillcock Key 281

Sink

 Basin Faucet 85

 Connection Washer 70

 Crumb Cups 76

 Hangers 74

 Kitchen Stopper 75

Laundry Tray Faucet85	Splicer, Nylon	157
Lugs73	Split Nut70
Self-Closing Basin Faucet86	Sponge396
Service86	Sponge Closet Gaskets48
Hose & Hose Bracket86	Sponges, Commercial396
Mop Hanger86	Sportsman L.E.D. Head-Lite307, 407
Single Sink Bibb85	Spray	
Undermount Installation Kit73	Delta Style Assembly73
Wall Mount Faucet85	Kitchen (Fit All)73
Sink Tailpiece, Chrome Plated Brass322	Rinse-Quik73
Sink Trap		Spray Assembly73
L.A. Pattern321	Spray Bottle397
L.A. Pattern Sink Trap321	Spray Paint299
Sink Trap w/ABS Adapter320	Spray Weld300
Sink Trap w/Sweat Connection320	Spreader401
Slab Drain250, 251, 253, 254	Spring Tubing Bender305
Sledgehammer290	Spud Extension, for Drains and Cleanouts222
Sleeve, Brass Compression135	Square Head Plug140, 355
Slip Jaw Pliers296	Stanadyne	
Slip Joint		Replacement Handles78
Cone, Washer71	Single Handle Replacement Buttons78
Nut70	Standard Waste and Overflow	
Nut And Washer71	1-Hole Full Kit62
Rough Brass, Nut70	1-Hole Half Kit61
Tee72	2-Hole Half Kit61
Washer71	Decorative	16-17
Slip Joint Nut334	Steam Vent168
Slip Joint Nut & Washer334	Steel Wool306
Slip Nut334	Stopper	
Slip-On Plastic Cap97	Basin And Tub62
Smooth Jaw Pliers296	Fit-All62
Tongue & Groove297	Flip-It Tub62
Snake, Drain King Mini301	Garbage Disposal75
Snap-Ease Access Panel95	Kitchen Sink75
Snap-in Drain225-226	Pop-Up Basin62
Snap-in Strainers21	Stove Bolt with Nut126
Snow Brush289, 400	Straight Air Valve167
Snow Pusher/Shovel289, 401	Straight Needle Valve, Plastic Push On147
Snow Scraper290, 400	Straight Steam Vent168
Snow Shovel289, 401	Strainer	
Soap And Lotion Dispenser, Chrome Plated73	ABS Body And Post Basket75
Soap Dish40	Adjustable, and Spud283
Soap Stones And Holders294	Beehive Urinal, Cast Brass75
Socket Ring226	Chrome Plated Brass Duo Basket75
Socket Savers285	Deep Cup Basket74
Solder		Deep Junior Duo Basket75
Phos-Copper Brazing Rod295	Duo Basket74
Shield Protective Blanket295	Duo, CP Brass74
Silver295	Economy Replacement Basket74
Solder Extension Tube, Chrome Plated Brass323	Fit-All Basket74
Solid Square Head Plug151	Flat Duplex75
Space Heater Fittings139	Flat Top Grid74
Spacer		Flexible Hair75
Air Gap69	Junior Duo Basket75
Closet Bend55	Plumb Easy Sink Wrench284
Foam55	Quick Fit Stainless Steel Basket74
Styrofoam Closet Flange55	Shallow Cup Duo Basket74
Spanner/Strainer Wrench283	Stainless Steel Deep Cup Basket75
Specialty Faucet36	Stainless Steel Duo Basket75
Splash Guard, Garbage Disposal76	Twist And Lock Basket74

Wrench283

S-Trap

ABS329

Chrome Plated Brass320

PVC327

Straps

Cam305

Camouflage, with Hooks305

Duct304

Heavy Duty Utility305

Ratchet Tie Down305

Ratchet, with Step Release J-Hooks305

Strap Wrench284

Stretch Wrap, Film and Dispenser104

Striking Tools290

Stud Guard

2 Hole118

6 Hole118

20-holes118

Interlocking118

Self Nailing118

Stud Protectors and Plate118

Stud Shoe118

Super Shims184

Supply Stop

Easy Connect Tee84

Multi-Turn24, 84

PlumBite145

Quarter Turn24, 84

Repair Stop Valve84

Supply Tubes

Closet26

Flexible Basin84

Flexible with Rubber Nose84

Lavatory26

PEX84

PEX With Ferrule84

Sure Grip Escutcheon338

Sure Sweat Dissolvable Pipe Plugs296

Surge Protector406

Sweat Male Adapter72

Sweat Male Adapter/Marvel Rings72

Swimming Pool Valves168

Swivel Drum Trap346

Swivel-Lite306, 407

4 D/6 Volt307, 407

Industrial Flashlights306, 407

Swivel Ring128

T

Tailpiece322

ABS331

Brass Direct Connect Dishwasher324

Brass Double Flange322

Brass Sink322

Slip Joint324

Slip Joint w/1/2" Sweat Branch325

Threaded Connection Dishwasher324

Trap Primer68

Trap Primer334

Tailpiece Extension186

Tamping Bar290

Tamping/Digging Bar290

Tank Ball45

Tank to Bowl

Bolt Kit for American Standard54

Bolt Kit for Gerber54

Bolt Kit for Mansfield54

Bolt Set54

Components55

Gasket55

Offset Bolts54

Offset Tank to Bowl Bolts54

Set54

Tri-Bolt Tank to Bowl Bolt Set54

Tri-Tank to Bowl Bolt Kit for American Standard54

Tank Trip Lever26, 27, 28, 44, 45

Eljer Touch Flush Assembly45

Fit-All44

for American Standard27, 44

for Crane44

for Eljer27, 44

for Kohler27, 45

for Mansfield45

for ToTo28, 45

for Universal Rundle/Sears28, 45

for Western Pottery45

Ultrafit26, 45

Universal28

Tape

Box Sealing103, 405

Duct103, 405

Electrical103

Gas Line Marking Labels305

Insulation112

Pipe Wrap

Domestic Pipe Wrap Tape103

Imported Pipe Wrap Tape103

Primer for Pipe Wrap Tape103

Thread Seal

Jar Display103

PTFE Thread Seal Tape103

PTFE Yellow Gas Line Thread Seal Tape103

Slic-tite® High Density Thread Sealants103

Tape, Caution400

Tape Measure294

Locking293, 294, 405

Long294

Neon Precision294

PlumbRule294

T-Cone Cleanout Repair Plugs96

Tee

45° Flare Tube Fitting137

Banded354

Banded, Black Malleable354

Baseboard374

Black Plastic PEX144

Brass Compression135

Brass Hose Barb156

Brass PEX142

Bronze150

Bronze Compression96	Cast DWV377
Cast DWV376	Cast Iron275
Chrome Plated152	with Plug231, 275
Double377	Test Tee, Cast Iron275
Double, Cast DWV377	Test Tee with Plug231, 275
Double Long Turn T-Y377	Test Tee w/Plug231
Double Sanitary, PVC DWV345	Texas Pattern Gas Ball Valve165
Drop373	The Green Drain Waterless Trap Seal222
Forged Brass/Cast Pressure373	Thermometer	
Insert, Nylon158	Bi-Metal Dial117
Insert, Poly159	Dial116
Insert, Red Brass160	Hot Water/Refrigerant Line116
Nylon157	Pocket Test117
Plastic Push On147	Weksler Industrial Multi-Angle116
PlumBite145	Threaded Extension Tube, Chrome Plated Brass323
Press Fitting372	Threaded Steel Rod129
PVC Compression96	Thread Sealants, Slic-tite® High Density103
PVC DWV344	Thread Sealing Compound, Slic-tite® Heavy Duty301
Qwik98	Thread Seal Tape	
Reducing, Banded Black Malleable354	PTFE103
Sanitary, PVC DWV344	PTFE Yellow Gas Line103
Slip Joint72	Tissue Roller69
Space Heater Fitting139	Toggle Bolt126
Street, Banded Black Malleable353	Toilet Paper Holder40
Test377	Toilet Seat	
Tubular, Chrome Plated324	Adult/Juvenile Residential Plastic385
White Plastic PEX143	Builder Grade Residential Plastic386
Wrot, Copper368, 369	Commercial Baby Bowl Plastic388
Wrot DWV375	Decorative Natural Finish, Solid Oak383
Yellow Brass140	Decorative Piano Finish, Solid Bamboo383
Tee Plug, Inflatable98	Decorative Piano Finish, Solid Oak383
Test Cap		Deluxe Commercial Plastic387
Flexible PVC97	Deluxe Molded Wood381
Knockout97	Deluxe Residential Plastic384
PVC Dual Fit97	Designer Acrylic390
PVC Test Cap97	Extra Heavy Duty Commercial Plastic386
Slip-On Plastic97	Heavy Duty Commercial Plastic386
Techno Test Plug97	Light Duty Commercial Plastic389
Wrot DWV375	Premium Commercial/Institutional Plastic388
Test Gauge		Premium Heavy Duty Commercial Plastic389
5 Pound Gas115	Premium Molded Wood381
Assembly115	Premium Residential Plastic384
Gas115	Replacement Hardware390
Gas Test Gauge Assembly115, 116	Specialty Plastic389
Gas Testing Equipment114	Standard and Deluxe Soft Seats390
Liquid Filled Pressure Gauge114	Standard Commercial Plastic388
Pressure Gauge115	Standard Molded Wood382
Sillcock/Water or Gas Test Gauge Assembly115	Standard Residential Plastic385
Tridicator116	Utility Grade Residential Plastic386
Water115	Utility Molded Wood383
Test Plug		Tongue & Groove Pliers296
Cast Iron97	Toothbrush Holder39
Combination96	Top Grade Gradient Level306
Economy96	Top Hat Washer48
"Plum-Tite" Mechanical96	Torpedo Level306, 404
Pneumatic97	Torque Wrench314
Pneumatic-Hydraulic98	Totes	
T-Cone96	2CanCaddy302
Two Stage Long98	20 Compartment Parts Box302
Test Tee		Bucket Caddies302

Combo Nipple Caddy 302
 Fitting Tote Tray 302
 Fitting Tray 302
 Plastic Nipple Caddy 302
 Steel Nipple Caddy Tray 302
 Tool 302
 Utility Tote Tray 302
 Utility Tray 302
Towel Bar 38
Towel Hook 39
Towel Ring 39
Towels
 Cotton Plumbers Handy 396
 Wypall Teri 396
Traffic Floor Drain 224-225
Transition Coupling, Flexible 99
Trap Adapter 346
Trap Adapters 71
Trap Bushing 59
Trap Cover 124
 Drum 124
Trap Primer Tailpiece 68, 334
Trash Bags 396
Tray Plug 75, 335
Tridicator 116
Trip Lever
 Trim 66
 with Spring 61
Trouble Light 308
Trowel 290
Tub and Shower Faucet 35-36
 Ceramic Cartridge 37
Tub And Shower Valve Wrench Set 281
Tubing
 Clear Vinyl 117
 Natural Polyethylene 117
 Soft Aluminum 117
Tubing Benders
 3-N-1 305
 Spring 305
Tubing Cutter
 Copper 287
 Economy 287
 Mini 287
 Quick Release 287
 Ratcheting Handle Copper 287
 Telescoping 286
 Vinyl 286
Tub Spout
 Chrome Plated 60
 Decorative 10-11
 Solid Brass 61
 Telescoping 60
Tubular Bath Waste Full Kit 18
Turnout Bend Support for PEX 120
Twine
 10 lb. Tying Twine with Dispenser Box 123
 Binder Sisal 123, 401
 Mason's Nylon 123
Twin Elbow Bushing 59

Twist Light 307
Twist-Off Strap Tool 284
Twist To Lock Plastic Fittings 146
U
U-Bend, PVC DWV 346
Union
 45° Flare Tube 138
 45° Flare Tube Fitting 137
 Black Malleable 355
 Brass Compression 135
 Bronze 150
 Chrome Plated 153
 Copper 367
 Forged Brass/Cast Pressure 374
 Plastic Push On 147
 Space Heater Fitting 139
 Stack Tube Tee, Twist To Lock 146
 Twist To Lock 146
Union, Brass to Iron Seat 355
Universal Beam Clamp 127
Universal Copper Thermocouple 112
Universal Drain Wrench 282
Urinal
 Flange 183
 Flange Kits 183
 Screen 396
 Spud 47
 Strainer 75
 Strainer, Cast Brass Beehive 75
Utility Drain 226
Utility Knife 402
Utility Light 307
Utility Pry Bar 290
Utility Shower 59
Utility Sink 85
Utility Strap 305
V
Vacuum Gauge 116
Valley, Replacement Handles 78
Valve Grease 301
Valve Key 291
Valve Seal
 Korky 49
 Korky for Champion 4 49
Vent Cap 241
Vent Elbow 342
Vinyl Gloves 304, 397
W
Wall Bend 322
Washer
 Aqua Seal 48
 Assorted Kit 72
 Basket Strainer 70
 Beveled Ballcock Shank 48
 Beveled Bibb 48
 Beveled Slip Joint Washer 335
 Carrier Nuts and Washer Set 127
 Cone Slip Joint 71
 Fender 127
 Flanged Poly Tailpiece 71, 335

Flanged Poly Tailpiece Washer	335	Irrigation Box	131
Flat	127	Round Valve Box	131
Flat Bibb	48	Water Meter Box	130
LDP Blue Slip Joint	335	Water Meter Box Keys and Covers	130
Materials	172	Water Meter Coupling Complete	130
Poly Beveled Slip Joint	335	Water Pump Pliers	296
Rubber Slip Joint Washer	335	Water Supply Tubes	25
Sink Connection	70	Water Tank	112
Slip Joint	71	Water Volume Control	58
Square Cut Rubber Slip Joint	335	Water Volume Restrictor	58
Top Hat	48	Wax Gaskets	55
Washing Machine Repair		Waxless Gasket	183
Boxes		WD-40® Lubricant	305, 405
with Hammer Arrestor	100	Wet-R-Dri Roofing Cement	124
with Valves	99	Whitlam	
Hoses		“Blue Magic” Pipe Joint Compound	300
Drain	101	Seal Unyte	300
Fit-All Drain	101	“Select Unyte” Teflon Pipe Joint Compound	301
Mixer	101	Wire Brush	299, 300
Washing Machine	101	Wire Connectors, Screw-On	309
Pan	101	Wood Bits	
Wasp and Hornet Spray	304, 401	Dual Auger	293
Waste and Overflow		Flat “Paddle”	293
Aluminum Bar	66	Wool, Steel	306
Test Kits	66	Work Light	307, 406
Waste Arm		Wrecking Bar	290
ABS	330	Wrench	
Chrome Plated Brass	322	4-Way Countersunk Plug	282
PVC	327	4-Way Plug	282
Rough Brass	325	4-Way P.O. Plug	282
Waste Connector	71, 335	6-Way Countersunk Plug	282
Waste w/Dishwasher Connection	331	Adjustable	284
Water Detector	309	Adjustable Strainer And Spud	283
Water Detector, Leak Alert	309	Aluminum Pipe	284
Water Hammer Arresters	173	Angle Compression Stop	282
Water Heater Repair		Box	284
Connector		Curb Box	284
Braided Stainless Steel	113	Do All Plumbers	284
Corrugated Copper	113	Dual Kwik Tie	282
Corrugated Stainless Steel	113	Element	281
Dielectric Nipple	113	Faucet Seat	282
Dielectric Union	112	Garbage Disposal	281
Gasket and Insert for Dielectric Union	113	Heavy Duty Pipe	284
Pan		Mega Torque	281
Adapter	114	Moen Stem And Cartridge	283
Galvanized	114	No Hub Torque	281
Safety	114	Plumb Easy Sink Strainer	284
Water Heater	114	Quick Drain	283
Run-Off Tube	114	Radiator Spud	281
Stand		Seat, for Recessed Seats	282
Stand-rite	114	Set	281
Water Heater Stand	114	14 Piece Folding Hex Key Wrench	281
Thermal Expansion Tank	112	Tub And Shower Valve Wrench	281
Universal Copper Thermocouple	112	Sink Drain	283
Waterless Trap Seal	222	Spanner/Strainer	283
Water Meter Keys	291	Spud	283
Combo	291	Spud With Hinged Arm	283
Gate Valve Key	291	Strainer	283
Water Meter Repair		Strap	284
Gasket Only for Water Meter Couplings	130	Universal Drain	282

Wye

Cast DWV377
Double.....377
Double, Cast DWV.....377
PVC DWV343

Wypall

Teri Towels.....396
Waterless Hand Wipes.....397

Y

Yellow Brass Pipe Fittings

Bell Reducer140
Bushing.....141
Coupling.....140
Elbow.....140
Lock Nut.....141
Nipple.....141
Plug.....140, 141
Tee.....140

Z

Zinc Plated Clevis Hanger128
Zip Ties.....304

<u>PART NO.</u>	<u>PG #</u>	<u>PART NO.</u>	<u>PG #</u>	<u>PART NO.</u>	<u>PG #</u>	<u>PART NO.</u>	<u>PG #</u>
1550010	32	161650295	375	300B0360	358	30180	356
1550110	32	161650303	375	300B0372	358	301G0218	358
1550200	33	161650390	375	300B0518	358	301G0224	358
1550203	33	161650398	375	300B0524	358	301G0230	358
1550205	33	161650399	375	300B0530	358	301G0236	358
1550210	33	161650650	375	300B0536	358	301G0248	358
1550220	34	161650663	375	300B0542	358	301G0260	358
1550221	34	161720215	375	300B0548	358	301G0318	358
1550222	34	161720295	375	300B0560	358	301G0324	358
1550223	37, 79	161720390	375	300B0572	358	301G0336	358
1550250	34	161720650	375	300B0718	358	301G0348	358
1550300	34	162350215	375	300B0724	358	301G0360	358
1550301	34	162350295	375	300B0730	358	301G0518	358
1550350	34	162350390	375	300B0736	358	301G0524	358
1550400	32	162420295	375	300B0742	358	301G0530	358
1550450	32	162540215	375	300B0748	358	301G0536	358
1550500	32	162540295	375	300B0754	358	301G0542	358
1550505	32	162540390	375	300B0760	358	301G0548	358
1550600	34	162900215	375	300B0772	358	301G0560	358
1550601	34	162900295	375	300B1018	358	301G0572	358
1554001	33	162900390	375	300B1024	358	301G0718	358
1554002	33	162900650	375	300B1030	358	301G0724	358
1554010	33	162950215	375	300B1036	358	301G0730	358
1554011	33	162950295	375	300B1048	358	301G0736	358
1554030	33	162950390	375	300B1060	358	301G0742	358
1554031	33	164100303	375	300B1066	358	301G0748	358
1554032	33	164100398	375	300B1072	358	301G0754	358
1554040	33	164100399	375	300B1218	358	301G0760	358
1554041	33	164100663	375	300B1224	358	301G0772	358
1554042	33	164100664	375	300B1230	358	301G1018	358
1554050	33	164600390	375	300B1236	358	301G1024	358
1554051	33	164600398	375	300B1248	358	301G1030	358
1558001	32	1812101	32	300B1260	358	301G1036	358
1558002	32	1812103	32	300B1272	358	301G1042	358
1558003	32	1820070	34	300B1518	358	301G1048	358
1558004	32	1822020	36	300B1524	358	301G1060	358
1558010	31	1822025	36	300B1530	358	301G1072	358
1558011	31	1822026	36	300B1536	358	301G1218	358
1558012	31	1828010	36	300B1548	358	301G1220	358
1558013	31	1836010	36	300B1560	358	301G1224	358
1558015	32	1836015	36	300B1572	358	301G1230	358
1558020	31	1836050	36	300B2018	358	301G1236	358
1558021	31	1850022	35	300B2024	358	301G1242	358
1558030	31	1854010	35	300B2030	358	301G1248	358
1558031	31	1854015	35	300B2036	358	301G1260	358
1558032	31	1854020	35	300B2042	358	301G1518	358
1558033	31	1854025	36	300B2048	358	301G1524	358
1558040	31	1854030	35	300B2060	358	301G1530	358
1558050	32	1854035	36	300B2072	358	301G1536	358
1558052	32	1855050	34	300B2530	358	301G1548	358
1558060	31	1855051	35	300B3024	358	301G1560	358
1558061	31	1855052	35	300B3036	358	301G2018	358
1558070	31	1855055	35	300B4018	358	301G2024	358
1558071	31	24452633W	389	300B4060	358	301G2030	358
1558072	31	24452634W	389	30100	356	301G2036	358
161010295	375	24456461W	389	30110	356	301G2048	358
161010390	375	300B0218	358	30112	356	301G2060	358
161050215	375	300B0224	358	30115	356	301G3018	358
161050295	375	300B0230	358	30120	356	301G3024	358
161050390	375	300B0236	358	30125	356	301G4018	358
161570050	375	300B0248	358	30130	356	301G4048	358
161570100	375	300B0260	358	30135	356	30200	356
161570150	375	300B0272	358	30140	356	30210	356
161570215	375	300B0318	358	30145	356	30211	356
161570295	375	300B0324	358	30150	356	30212	356
161570390	375	300B0330	358	30155	356	30215	356
161570650	375	300B0336	358	30160	356	30220	356
161650215	375	300B0348	358	30170	356	30225	356

<u>PART NO.</u>	<u>PG #</u>	<u>PART NO.</u>	<u>PG #</u>	<u>PART NO.</u>	<u>PG #</u>	<u>PART NO.</u>	<u>PG #</u>
30230	356	31000	356	32055	357	36080	357
30235	356	31010	356	32060	357	36090	357
30240	356	31011	356	32065	357	36206	40
30245	356	31012	356	32070	357	36208	40
30250	356	31014	356	32075	357	36214	40
30255	356	31020	356	32080	357	4116	38
30260	356	31025	356	32090	357	4117	38
30270	356	31030	356	32500	357	4118	38
30280	356	31035	356	32510	357	4130	38
30290	356	31040	356	32511	357	4131	38
30300	356	31045	356	32512	357	4131SN	38
30310	356	31050	356	32518	358	4140	38
30311	356	31055	356	32520	358	4141	38
30312	356	31060	356	32530	357	4141SN	38
30315	356	31065	356	32535	357	4143	38
30320	356	31070	356	32540	357	50100	356
30325	356	31075	356	32545	357	50110	356
3033	38	31080	356	32550	357	50111	356
30330	356	31090	356	32555	357	50112	356
30335	356	31200	356	32560	357	50115	356
30340	356	31210	356	32570	357	50120	356
30345	356	31210TOE	357	32580	357	50125	356
30350	356	31211	356	32590	357	50130	356
30355	356	31212	356	33000	357	50135	356
3036	38	31212TOE	357	33010	357	50140	356
30360	356	31213	356	33011	357	50145	356
30370	356	31214	356	33012	357	50150	356
3038	38	31220	356	33018	358	50155	356
30380	356	31225	356	33030	357	50160	356
3040	38	31230	356	33035	357	50170	356
30500	356	31235	356	33040	357	50180	356
3051	38	31240	356	33045	357	50190	356
30510	356	31245	356	33050	357	50200	356
30511	356	31250	356	33055	357	50210	356
30512	356	31255	356	33060	357	50211	356
30515	356	31260	356	33070	357	50212	356
30520	356	31270	356	33080	357	50215	356
30525	356	31280	356	33090	357	50220	356
30530	356	31285	356	33500	357	50225	356
30535	356	31290	356	33540	357	50230	356
30540	356	31500	356	33550	357	50235	356
30545	356	31510	356	34000	357	50240	356
30550	356	31511	356	34010	357	50245	356
30555	356	31512	356	34011	357	50250	356
30560	356	31514	356	34012	357	50255	356
30570	356	31520	356	34024	358	50260	356
30575	356	31525	356	34035	357	50270	356
30580	356	31530	356	34040	357	50280	356
30590	356	31535	356	34045	357	50290	356
30700	356	31540	356	34050	357	50300	356
30710	356	31545	356	34055	357	50310	356
30711	356	31550	356	34060	357	50312	356
30712	356	31555	356	34070	357	50315	356
30715	356	31560	356	34080	357	50320	356
30720	356	31570	357	34090	357	50325	356
30725	356	31580	357	35045	357	50330	356
30730	356	31590	357	35050	357	50335	356
30735	356	32000	357	35055	357	50340	356
30740	356	32010	357	35060	357	50345	356
30745	356	32011	357	35070	357	50350	356
30750	356	32012	357	35080	357	50355	356
30755	356	32013	357	36000	357	50360	356
30760	356	32025	357	36010	357	50370	356
30765	356	32030	357	36011	357	50380	356
30770	356	32035	357	36012	357	50500	356
30775	356	32040	357	36045	357	50510	356
30780	356	32045	357	36060	357	50511	356
30790	356	32050	357	36070	357	50512	356

<u>PART NO.</u>	<u>PG #</u>	<u>PART NO.</u>	<u>PG #</u>	<u>PART NO.</u>	<u>PG #</u>	<u>PART NO.</u>	<u>PG #</u>
50515	356	51520	356	54080	357	97894	39
50520	356	51525	356	54090	357	97896	39
50525	356	51530	356	56000	357	97897	39
50530	356	51535	356	56010	357	A01001	76
50535	356	51540	356	56011	357	A01002	76
50540	356	51545	356	56012	357	A01003	76
50545	356	51550	356	56045	357	A01004	76
50550	356	51555	356	56050	357	A01005	76
50555	356	51560	356	56055	357	A01006	76
50560	356	51570	357	56060	357	A01007	76
50570	356	51580	357	56070	357	A01008	76
50580	356	51590	357	56080	357	A01010	76
50590	356	52000	357	56090	357	A01011	76
50700	356	52010	357	605B	357	A01012	76
50710	356	52011	357	605G	357	A01013	76
50711	356	52012	357	607B	357	A01014	77
50712	356	52025	357	607G	357	A01015	76
50715	356	52030	357	610B	357	A01016	76
50720	356	52035	357	610G	357	A01017	76
50725	356	52040	357	62062	39	A01018	76
50730	356	52045	357	62070	39	A01019	23
50735	356	52050	357	660001	37,78	A01020	76
50740	356	52055	357	660011	37,78	A01021	76
50745	356	52060	357	660041	37,78	A01022	76
50750	356	52070	357	660042	37,78	A01023	76
50755	356	52080	357	660071	37,78	A01024	77
50760	356	52090	357	660081	37,78	A01026	77
50770	356	52500	357	660143	37,78	A01027	77
50775	356	52510	357	97170	38	A01029	77
50780	356	52511	357	97172	38	A01030	77
50790	356	52512	357	97173	38	A01031	77
51000	356	52524	358	97174	38	A01032	77
51010	356	52530	357	97177	38	A01033	77
51011	356	52535	357	97180	38	A01034	77
51012	356	52540	357	97181	40	A01035	77
51014	356	52545	357	97182	40	A01036	77
51020	356	52550	357	97183	38	A01037	76
51025	356	52555	357	97184	38	A01040	77
51030	356	52560	357	97185	40	A01041	77
51035	356	52570	357	97186	40	A01050	76
51040	356	52580	357	97187	40	A01051	76
51045	356	52590	357	97188	40	A01060	76
51050	356	53000	357	97189	40	A01061	76
51055	356	53010	357	97192	40	A01062	76
51060	356	53011	357	97193	40	A01900	77
51070	356	53012	357	97194	39	A01901	77
51080	356	53030	357	97195	39	A04006	95
51090	356	53035	357	97196	39	A04012	95
51200	356	53040	357	97203U	39	A05008	95
51210	356	53045	357	97300	40	A05014	95
51211	356	53050	357	97301	40	A05027	95
51212	356	53055	357	97302	40	A06008	95
51220	356	53060	357	97303	40	A06014	95
51225	356	53070	357	97304	39	A10001	5
51230	356	53080	357	97305	39	A10001	69
51235	356	53550	357	97306	39	A10002	5
51240	356	54000	357	97307	39	A10004	5
51245	356	54010	357	97308	38	A10010	5
51250	356	54011	357	97309	38	A10011	5
51255	356	54012	357	97310	38	A10015	5
51260	356	54024	358	97311	38	A10017	5
51270	356	54035	357	97886	38	A10018	5
51280	356	54040	357	97887	38	A10019	5
51290	356	54045	357	97888	40	A10100	69
51500	356	54050	357	97889	40	A10150	69
51510	356	54055	357	97890	39	A10200	69
51511	356	54060	357	97891	39	A10901	69
51512	356	54070	357	97892	39	A11001	164

PART NO.	PG #	PART NO.	PG #	PART NO.	PG #	PART NO.	PG #
A11002	164	B02052	75, 337	B04600	240	B05859	100
A11003	164	B02060	75	B05001	396, 415, 416	B05860	100
A11004	164	B02100	4	B05002	397	B05900	99
A11005	164	B02101	4	B05003	396, 415, 416	B05901	99
A11006	164	B02102	4, 75, 337	B05004	396	B05910LF	100
A11007	164	B02103	75, 337	B05007	397	B05911LF	100
A11008	164	B02301	3	B05008	397	B05913LF	100
A11011	164	B02303	3	B05010	398	B05914LF	100
A11016	164	B02304	3	B05011	398, 413	B05925LF	100
A11017	164	B02305	3	B05012	397	B05926LF	100
A33001	127	B02400	3	B05015	398, 413, 416	B05931LF	100
A33002	127	B02401	3	B05020	399	B05932LF	100
A33005	127	B02404	3	B05021	399, 413	B05940	100
A33006	127, 395	B02405	3	B05025	396	B05941	100
A33010	126	B02406	3	B05026	396, 415	B05942	100
A40001	263	B02407	3	B05030	426	B05943	100
A40002	263	B02408	3	B05050	397, 415, 416, 426	B05944	100
A40003	263	B0240BN	3	B05051	397	B05946	100
A97001	173	B0240BS	3	B05090	399, 413	B05947	100
A97002	173	B0240PN	3	B05100	396	B05948	100
A97004	173	B0240PS	3	B05101	396	B05949	100
A97007	173	B0240RB	3	B05150	240	B05950	100
A97009	173	B0240WB	3	B05150K	240	B06001	227, 259
A97011	173	B0250BN	4	B05200	240	B06010	227
AB05	357	B0250RB	4	B05200K	240	B06100	227
AB07	357	B0250WB	4	B05300	240	B07001	64
AG05	357	B03001	3	B05300K	240	B07002	64
AG07	357	B03001B	3	B05400	240	B07003	64
AG10	357	B03003	3	B05400K	240	B07004	64
B00001	119	B03003B	3	B05600	240	B07005	64
B00002	120	B03004	3	B05740	100	B07006	64
B00003	119	B03004B	3	B05741	100	B07007	64
B00004	119	B03005	3	B05742	100	B07008	64
B00005	119	B03005B	3	B05743	100	B07010	15, 65
B00006	120	B03010	74, 337	B05744	100	B07011	15, 65
B00007	120	B03015	74, 337	B05746	100	B07012	16, 65
B00008	120	B03050	3	B05747	100	B07013	16, 65
B00009	120	B03400	3	B05748	100	B07014	15, 65
B00013	120	B03401	3	B05749	100	B07015	15, 65
B00014	120	B03405	3	B05750	100	B07016	16, 65
B00016	120	B03406	3	B05751	100	B07017	65
B00017	120	B03407	3	B05752	100	B07020	64
B00018	120	B03408	3	B05753	100	B07021	64
B00019	120	B0350BN	3	B05754	100	B07022	64
B00020	120	B0350RB	3	B05755	100	B07023	64
B00021	119	B0350WB	3	B05756	100	B07024	64
B00022	119	B04006	240	B05757	100	B07025	64
B00024	119	B04007	240	B05758	100	B07027	64
B00025	119	B04008	240	B05759	100	B07030	15, 65
B01002	274	B04150	240	B05760	100	B07031	15, 65
B01003	274	B04150K	240	B05840	100	B07032	16, 65
B01004	274	B04151K	240	B05841	100	B07033	16, 65
B01006	274	B04200	240	B05842	100	B07034	15, 65
B01013	274	B04200K	240	B05843	100	B07035	15, 65
B01014	274	B04201	240	B05844	100	B07036	16, 65
B01016	274	B04201K	240	B05845	100	B07037	16, 65
B01017	274	B04300	240	B05847	100	B07038	64
B01018	274	B04300K	240	B05848	100	B07039	64
B01019	274	B04301	240	B05849	100	B07040	64
B01020	274	B04301K	240	B05850	100	B07041	64
B02001	3	B04303	240	B05851	100	B07042	64
B02003	3	B04304	240	B05852	100	B07043	64
B02004	3	B04400	240	B05853	100	B07044	64
B02005	3	B04400K	240	B05854	100	B07045	64
B02008	3	B04401	240	B05855	100	B07046	64
B02049	75, 337	B04401K	240	B05856	100	B07047	64
B02050	4, 75, 337	B04403	240	B05857	100	B07048	64
B02051	75, 335	B04404	240	B05858	100	B07049	64

PART NO.	PG #	PART NO.	PG #	PART NO.	PG #	PART NO.	PG #
B07050	65	B07139	64	B0717BS	17	B0811WB	16
B07051	65	B0713AB	16	B0717PN	17	B0813AB	16
B07052	15, 65	B0713AL	16	B0717PS	17	B0813AL	16
B07053	15, 65	B0713AN	16	B0717PW	17	B0813AN	16
B07054	15, 65	B0713BI	16	B0717RB	17	B0813BI	16
B07055	15, 65	B0713BL	16	B0717WB	17	B0813BL	16
B07056	65	B0713BN	16	B0718AB	17	B0813BN	16
B07057	65	B0713BS	16	B0718AL	17	B0813PN	16
B07058	15, 65	B0713PN	16	B0718AN	17	B0813PS	16
B07059	15, 65	B0713PS	16	B0718BI	17	B0813PW	16
B07060	15, 65	B0713PW	16	B0718BL	17	B0813RB	16
B07061	15, 65	B0713RB	16	B0718BN	17	B0813WB	16
B07070	66	B0713WB	16	B0718BS	17	B0815AB	17
B07071	66	B07140	64	B0718PN	17	B0815AL	17
B07072	66	B07141	64	B0718PS	17	B0815AN	17
B07073	66	B07142	64	B0718PW	17	B0815BI	17
B07074	66	B07143	64	B0718RB	17	B0815BL	17
B07075	66	B07144	64	B0718WB	17	B0815BN	17
B07076	66	B07146	64	B07200	66	B0815PN	17
B07077	66	B07147	64	B07201	66	B0815PS	17
B07101	64	B07148	64	B07202	66	B0815PW	17
B07102	64	B07149	64	B07203	66	B0815RB	17
B07103	64	B07150	65	B07210	66	B0815WB	17
B07104	64	B07151	65	B07219	62	B0816AB	17
B07105	64	B07152	17, 65	B07220T	61	B0816AL	17
B07106	64	B07153	17, 65	B07221T	61	B0816AN	17
B07107	64	B07154	17, 65	B07310	325	B0816BI	17
B07108	64	B07155	17, 65	B07311	325	B0816BL	17
B07110	16	B07156	65	B07312	325	B0816BN	17
B07110	65	B07157	65	B07374	66	B0816BS	17
B07111	16, 65	B07158	17, 65	B07375	66	B0816PN	17
B07111S	61	B07159	17, 65	B07376	66	B0816PS	17
B07112	17, 65	B0715AB	17	B07377	66	B0816PW	17
B07113	17, 65	B0715AL	17	B07470	66	B0816RB	17
B07114	16, 65	B0715AN	17	B07472	66	B0816WB	17
B07114S	61	B0715BI	17	B07476	66	B0817AB	17
B07115	16, 65	B0715BL	17	B07477	66	B0817AL	17
B07116	17, 65	B0715BN	17	B0750BN	15	B0817BI	17
B07117	17, 65	B0715BS	17	B0750RB	15	B0817BL	17
B0711AB	16	B0715PN	17	B0750WB	15	B0817BN	17
B0711AL	16	B0715PS	17	B0751BN	15	B0817BS	17
B0711AN	16	B0715PW	17	B0751RB	15	B0817PN	17
B0711BI	16	B0715RB	17	B0751WB	15	B0817PS	17
B0711BL	16	B0715WB	17	B0752BN	15	B0817PW	17
B0711BN	16	B07160	17, 65	B0752RB	15	B0817RB	17
B0711BS	16	B07161	17, 65	B0752WB	15	B0817WB	17
B0711PN	16	B0716AB	17	B0753BN	15	B0818AB	17
B0711PS	16	B0716AL	17	B0753RB	15	B0818AL	17
B0711PW	16	B0716AN	17	B0753WB	15	B0818AN	17
B0711RB	16	B0716BI	17	B0754BN	16	B0818BI	17
B0711WB	16	B0716BL	17	B0754RB	16	B0818BL	17
B07120	64	B0716BN	17	B0754WB	16	B0818BN	17
B07121	64	B0716BS	17	B0755BN	16	B0818PN	17
B07122	64	B0716PN	17	B0755NP	16	B0818PS	17
B07123	64	B0716PS	17	B0755RB	16	B0818PW	17
B07124	64	B0716PW	17	B0755WB	16	B0818RB	17
B07125	64	B0716RB	17	B08071	66	B0818WB	17
B07126	64	B0716WB	17	B0811AB	16	B0850BN	15
B07127	64	B07170	66	B0811AL	16	B0850RB	15
B07130	16, 65	B07171	66	B0811AN	16	B0850WB	15
B07131	16, 65	B07172	66	B0811BI	16	B0851BN	15
B07132	17, 65	B07173	66	B0811BL	16	B0851RB	15
B07133	17, 65	B0717AB	17	B0811BN	16	B0851WB	15
B07134	16, 65	B0717AL	17	B0811BS	16	B0852BN	15
B07135	16, 65	B0717AN	17	B0811PN	16	B0852RB	15
B07136	17, 65	B0717BI	17	B0811PS	16	B0852WB	15
B07137	17, 65	B0717BL	17	B0811PW	16	B0853BN	15
B07138	64	B0717BN	17	B0811RB	16	B0853RB	15

<u>PART NO.</u>	<u>PG #</u>	<u>PART NO.</u>	<u>PG #</u>	<u>PART NO.</u>	<u>PG #</u>	<u>PART NO.</u>	<u>PG #</u>
B0853WB	15	B144-0307	351	B165-0304	352	B21125	293
B0854BN	16	B144-0308	351	B165-0305	352	B21150	293
B0854RB	16	B144-0398	351	B165-0306	352	B21625	293
B0854WB	16	B144-0399	351	B165-0307	352	B235-0001	352
B0855BN	16	B144-0400	351	B165-0390	351	B235-0002	352
B0855RB	16	B144-0401	351	B165-0398	352	B235-0007	352
B0855WB	16	B144-0402	351	B165-0399	352	B235-0025	352
B10004	285	B144-0403	351	B165-0400	352	B235-0032	352
B10080	69	B144-0531	351	B165-0401	352	B235-0050	352
B10081	69	B144-0532	351	B165-0402	352	B235-0058	352
B10090	70	B144-0533	351	B165-0520	351	B235-0059	352
B10091	70	B144-0534	351	B165-0531	352	B235-0060	352
B10092	70	B144-0535	351	B165-0532	352	B235-0100	352
B10093	70	B144-0536	351	B165-0533	352	B235-0107	352
B10094	70	B144-0662	351	B165-0534	352	B235-0108	352
B10100	70	B144-0663	351	B165-0535	352	B235-0150	352
B10102	70	B144-0664	351	B165-0650	351	B235-0159	352
B10103	70	B144-0665	351	B165-0662	352	B235-0160	352
B10104	70	B144-0666	351	B165-0663	352	B235-0215	352
B10105	70	B144-0667	351	B165-0664	352	B235-0222	352
B10110	69	B144-0790	351	B165-0665	352	B235-0223	352
B10111	69	B144-0870	351	B165-0666	352	B235-0224	352
B10195	69	B144-0871	351	B165-0860	351	B235-0295	352
B10200	73	B144-0872	351	B165-0870	352	B235-0303	352
B10201	73	B144-0873	351	B165-0871	352	B235-0304	352
B10202	73	B144-0875	351	B165-0872	352	B235-0305	352
B1020AB	4	B144-1109	351	B165-0873	352	B235-0306	352
B1020AL	4	B144-1111	351	B165-1100	351	B235-0390	352
B1020AN	4	B155-0001	351	B195-0002	353	B235-0398	352
B1020BI	4	B155-0002	351	B195-0025	353	B235-0399	352
B1020BL	4	B155-0025	351	B195-0050	353	B235-0400	352
B1020BN	4	B155-0050	351	B195-0100	353	B235-0401	352
B1020PN	4	B155-0100	351	B195-0150	353	B235-0402	352
B1020PS	4	B155-0150	351	B195-0215	353	B235-0520	352
B1020PW	4	B155-0215	351	B195-0295	353	B235-0531	352
B1020RB	4	B155-0295	351	B20062	293	B235-0532	352
B1020WB	4	B155-0390	351	B20078	293	B235-0533	352
B11010	281, 423	B155-0520	351	B20094	293	B235-0650	352
B11011	281	B155-0650	351	B20109	293	B235-0662	352
B11012	281	B155-0860	351	B20125	293	B235-0663	352
B11013	281	B155-0975	351	B20141	293	B235-0860	352
B12210	99	B155-1100	351	B20156	293	B235-0975	352
B12320	99	B165-0001	351	B20172	293	B235-1100	352
B12430	99	B165-0002	351	B20188	293	B24050	293
B12640	99	B165-0007	352	B20203	293	B24056	293
B144-0007	351	B165-0025	351	B20219	293	B24063	293
B144-0032	351	B165-0032	352	B20234	293	B24075	293
B144-0033	351	B165-0033	352	B20250	293	B24081	293
B144-0058	351	B165-0050	351	B20266	293	B24088	293
B144-0059	351	B165-0058	352	B20281	293	B24100	293
B144-0060	351	B165-0059	352	B20297	293	B24113	293
B144-0107	351	B165-0060	352	B20313	293	B24125	293
B144-0108	351	B165-0100	351	B20328	293	B24150	293
B144-0109	351	B165-0107	352	B20344	293	B24175	293, 404
B144-0110	351	B165-0108	352	B20359	293	B24175	419
B144-0159	351	B165-0109	352	B20375	293	B24188	293, 404
B144-0160	351	B165-0110	352	B20391	293	B24188	419
B144-0161	351	B165-0150	351	B20406	293	B24200	293, 404
B144-0162	351	B165-0159	352	B20422	293	B24200	419
B144-0222	351	B165-0160	352	B20438	293	B24213	293, 404
B144-0223	351	B165-0161	352	B20453	293	B24213	419
B144-0224	351	B165-0162	352	B20469	293	B24225	293, 404
B144-0225	351	B165-0215	351	B20484	293	B24225	419
B144-0226	351	B165-0222	352	B20500	293	B24250	293, 404
B144-0303	351	B165-0223	352	B21075	293	B24250	419
B144-0304	351	B165-0224	352	B21087	293	B24251	293, 404
B144-0305	351	B165-0295	351	B21100	293	B24251	419
B144-0306	351	B165-0303	352	B21112	293	B24263	293, 404

PART NO.	PG #	PART NO.	PG #	PART NO.	PG #	PART NO.	PG #
B24263	419	B29702	299	B40025	72	B460-0306	354
B24375	293	B29801	299	B40026	72	B460-0315	354
B25001	397, 415	B29802	299	B40027	72	B460-0316	354
B254-0001	353	B29805	299, 402	B40028	72	B460-0317	354
B254-0002	353	B29805	421	B40030	72	B460-0318	354
B254-0025	353	B29806	299, 402	B40032	72	B460-0319	354
B254-0050	353	B29806	421	B40033	72	B460-0328	354
B254-0100	353	B29807	299, 402	B40034	72	B460-0329	354
B254-0150	353	B29807	421	B40035	72	B460-0330	354
B254-0215	353	B29808	299, 402	B40036	72	B460-0331	354
B254-0295	353	B29808	421	B45010	4, 73	B460-0339	354
B254-0390	353	B29850	395	B45014	73	B460-0340	354
B254-0520	353	B29851	395	B45200	86	B460-0342	354
B254-0650	353	B29875	285	B45215	86	B460-0350	354
B254-0860	353	B29900	300	B45216	86	B460-0390	354
B28025	285	B29901	299, 402	B45217	86	B460-0398	354
B28050	285	B29901	421	B45218	86	B460-0399	354
B28051	285	B29902	300, 402	B45220	86	B460-0400	354
B28075	285	B29902	421	B460-0001	354	B460-0401	354
B28076	285	B29999	285	B460-0002	354	B460-0402	354
B28100	285	B335-0050	351	B460-0025	354	B460-0413	354
B28125	285	B335-0100	351	B460-0032	354	B460-0414	354
B28150	285	B335-0150	351	B460-0050	354	B460-0415	354
B28200	285	B335-0215	351	B460-0056	354	B460-0416	354
B28375	285	B335-0390	351	B460-0057	354	B460-0417	354
B290-0001	353	B355-0025	353	B460-0058	354	B460-0429	354
B290-0002	353	B355-0050	353	B460-0059	354	B460-0430	354
B290-0025	353	B355-0100	353	B460-0100	354	B460-0431	354
B290-0050	353	B355-0150	353	B460-0106	354	B460-0444	354
B290-0100	353	B355-0215	353	B460-0107	354	B460-0447	354
B290-0150	353	B355-0295	353	B460-0108	354	B460-0457	354
B290-0215	353	B355-0390	353	B460-0109	354	B460-0470	354
B290-0295	353	B396-0001	355	B460-0116	354	B460-0520	354
B290-0390	353	B396-0002	355	B460-0117	354	B460-0531	354
B290-0520	353	B396-0025	355	B460-0118	354	B460-0532	354
B290-0650	353	B396-0050	355	B460-0150	354	B460-0533	354
B290-0860	353	B396-0100	355	B460-0158	354	B460-0534	354
B29025	285	B396-0150	355	B460-0159	354	B460-0535	354
B29050	285	B396-0215	355	B460-0160	354	B460-0536	354
B29051	285	B396-0295	355	B460-0162	354	B460-0650	354
B29075	285	B396-0390	355	B460-0169	354	B460-0662	354
B29076	285	B396-0520	355	B460-0170	354	B460-0663	354
B29100	285	B396-0650	355	B460-0171	354	B460-0664	354
B29125	285	B396-0860	355	B460-0180	354	B460-0665	354
B29150	285	B396-1100	355	B460-0181	354	B460-0666	354
B29200	285	B40000	72	B460-0182	354	B460-0667	354
B29300	306	B40001	72	B460-0215	354	B460-0668	354
B29310	306	B40002	72	B460-0221	354	B460-0860	354
B29375	285	B40003	72	B460-0222	354	B460-0870	354
B29400	306	B40004	72	B460-0223	354	B460-0871	354
B295-0001	353	B40005	72	B460-0224	354	B460-0872	354
B295-0002	353	B40006	72	B460-0234	354	B460-0873	354
B295-0025	353	B40007	72	B460-0235	354	B460-1100	354
B295-0050	353	B40008	72	B460-0236	354	B486-0050	353
B295-0100	353	B40009	72	B460-0237	354	B486-0100	353
B295-0150	353	B40010	72	B460-0245	354	B486-0150	353
B295-0215	353	B40011	72	B460-0246	354	B49001	59
B295-0295	353	B40012	72	B460-0247	354	B49002	59
B295-0390	353	B40013	72	B460-0248	354	B49010	59
B295-0520	353	B40014	72	B460-0256	354	B49011	59
B295-0650	353	B40015	72	B460-0257	354	B49012	59
B295-0860	353	B40017	72	B460-0258	354	B49013	59
B29500	290, 404	B40018	72	B460-0259	354	B49020	7, 59
B29501	290	B40019	72	B460-0295	354	B49021	7, 59
B29625	285	B40020	72	B460-0302	354	B49022	7, 59
B29699	299	B40021	72	B460-0303	354	B50001LF	152
B29700	299	B40023	72	B460-0304	354	B50002LF	152
B29701	299	B40024	72	B460-0305	354	B50003LF	152

PART NO.	PG #	PART NO.	PG #	PART NO.	PG #	PART NO.	PG #
B50004LF	152	B5155WBB	12	B657-0150	355	B74001LF	150
B50011LF	152	B5156AP	12	B657-0215	355	B74002LF	150
B50012LF	152	B5156BB	12	B657-0295	355	B74003LF	150
B50031LF	152	B5156BN	12	B657-0390	355	B74004LF	150
B50032LF	152	B5156PS	12	B657-0520	355	B74005LF	150
B50033LF	152	B5156RB	12	B657-0650	355	B74006LF	150
B50041LF	152	B5156WB	12	B657-0860	355	B74007LF	150
B50042LF	152	B5160AP	12	B66050	165	B74008LF	150
B50043LF	152	B5160BB	12	B66075	165	B74009LF	150
B50044LF	152	B5160BN	12	B66375	165	B74021LF	150
B50051LF	152	B5160BS	12	B67050	165	B74022LF	150
B50052LF	152	B5160PN	12	B67100	166	B74023LF	150
B50072LF	153	B5160PS	12	B67101	166	B74024LF	150
B50073LF	153	B5160RB	12	B67102	166	B74025LF	150
B50081LF	153	B5160WB	12	B67103	166	B74026LF	150
B50082LF	153	B5161AP	12	B67104	166	B74027LF	150
B50083LF	153	B5161BB	12	B67105	166	B74028LF	150
B50092LF	153	B5161BN	12	B67106	166	B74029LF	150
B50094LF	152	B5161PS	12	B67200	166	B74042LF	150
B50096LF	153	B5161RB	12	B67201	166	B74044LF	150
B50097LF	153	B5161WB	12	B67202	166	B74045LF	150
B50098LF	152	B55001	72	B67203	166	B74046LF	150
B50099LF	153	B55002	72	B67204	166	B74066LF	150
B50100LF	153	B55003	72	B67205	166	B74067LF	150
B50103LF	152	B55004	72, 335	B67206	166	B74081LF	150
B51003	12	B55005	72, 335	B67208	166	B74082LF	150
B51004	12	B55006	72, 335	B67209	166	B74083LF	150
B51005	12, 66	B55007	72, 335	B67210	166	B74084LF	150
B51006	66	B55008	72	B67211	166	B74085LF	150
B51007	12, 66	B55009	72	B67212	166	B74086LF	150
B51008	66	B55050	72	B67213	166	B74087LF	150
B51009	66	B55100LF	72	B67214	166	B74088LF	150
B51010	12, 66	B55101LF	72	B67215	166	B74089LF	150
B51011	66	B55103LF	72	B67216	166	B74090LF	150
B51014	13, 66	B55150	59	B67217	166	B74104LF	151
B51015	13, 66	B59000	169	B67218	166	B74105LF	151
B51019	12, 66	B59001LF	168	B67219	166	B74107LF	151
B51020	12, 66	B59002LF	168	B67312	166	B74108LF	151
B5112AP	13	B59050	169	B67313	166	B74121LF	151
B5112BB	13	B59075	169	B67315	166	B74122LF	151
B5112BI	13	B59100	169	B67316	166	B74123LF	151
B5112BN	13	B60001	58	B67317	166	B74124LF	151
B5112BS	13	B60002	58	B67320	166	B74125LF	151
B5112PW	13	B60099	269	B67321	166	B74126LF	151
B5112RB	13	B60950	169	B67322	166	B74127LF	151
B5112WB	13	B60975	169	B67323	166	B74128LF	151
B5114AP	13	B60994	269	B67375	165	B74129LF	151
B5114BB	13	B63050LF	142	B67937	165	B74132LF	151
B5114BN	13	B63075LF	142	B67975	165	B74140LF	151
B5114PB	13	B63100LF	142	B68001	165	B74142LF	151
B5114PN	13	B64050	165	B68050	165	B74144LF	151
B5114PS	13	B64075	165	B68058	165	B74145LF	151
B5114RB	13	B64100	165	B68375	165	B74148LF	151
B5114WB	13	B64125	165	B69050	165	B74150LF	151
B5155AB	12	B64150	165	B69121	165	B74152LF	151
B5155AL	12	B64200	165	B70001	4	B74153LF	151
B5155AN	12	B64375	165	B70003	4	B74154LF	151
B5155AP	12	B64450	165	B70004	4	B74155LF	151
B5155BB	12	B64475	165	B70006	4	B74156LF	151
B5155BI	12	B65050	165	B70007	4	B74157LF	151
B5155BL	12	B65075	165	B70008	4	B74160LF	151
B5155BN	12	B65100	165	B70009	4	B74161LF	151
B5155BNB	12	B65375	165	B70030	4	B74181LF	150
B5155BS	12	B657-0001	355	B70031	4	B74182LF	150
B5155PS	12	B657-0002	355	B70032	4	B74183LF	150
B5155PW	12	B657-0025	355	B70033	4	B74184LF	150
B5155RB	12	B657-0050	355	B70045	4	B74185LF	150
B5155WB	12	B657-0100	355	B70499	227, 259	B74186LF	150

PART NO.	PG #	PART NO.	PG #	PART NO.	PG #	PART NO.	PG #
B74187LF	150	B90075	167	C014WDO00	382	C02302	54
B74188LF	150	B90100	167	C014WDS00	382	C02303	54
B74189LF	150	B90125	167	C02000	52	C02310	54
B74200LF	151	B90150	167	C02000B	52	C02311	54
B74201LF	151	B90200	167	C02001	52	C023WD00	381
B74202LF	151	B90250	167	C02001B	52	C023WD01	381
B74203LF	151	B90300	167	C02002	52	C023WD02	381
B74204LF	151	B90400	167	C02002B	52	C023WD04	381
B74205LF	151	B91050	167	C02003	52	C02401	51
B74206LF	151	B91075	167	C02003B	52	C02402	51
B74207LF	151	B91100	167	C02004	52	C02403	51
B74208LF	151	B91125	167	C02004B	52	C02404	51
B74209LF	151	B91150	167	C02005	52	C02405	51
B74210LF	151	B91200	167	C02005B	52	C02421	51
B74212LF	151	B91250	167	C02010	52	C02422	51
B74213LF	151	B91300	167	C02010B	52	C02423	51
B74216LF	151	B91400	167	C02011	52	C02424	51
B74217LF	151	B92050	167	C02011B	52	C024WD00	381
B74218LF	151	B92075	167	C02012	52	C024WD01	381
B74220LF	151	B95150	168	C02012B	52	C024WD02	381
B74222LF	151	B95200	168	C02013	52	C024WD04	381
B74223LF	151	BI05	357	C02014	52	C02800	53
B74224LF	151	BI07	357	C02014B	52	C02801	53
B74228LF	151	BI10	357	C02015	52	C02802	53
B74229LF	151	BI12	357	C02015B	52	C02803	53
B74230LF	151	BI15	357	C02020	52	C02804	53
B74231LF	151	BI20	357	C02020B	52	C02805	53
B74232LF	151	BIN004	131	C02021	52	C02806	53
B74235LF	151	BIN005	131	C02021B	52	C02807	53
B74262LF	150	BIN008	131	C02022	52	C02808	53
B74263LF	150	BIN012	131	C02022B	52	C02809	53
B74264LF	150	BOX006	131	C02023	52	C02810	53
B74265LF	150	BOX008	131	C02023B	52	C02811	53
B74266LF	150	BOX011	131	C02024	52	C02812	53
B74267LF	150	BWV200	240	C02024B	52	C02813	53
B74268LF	150	BWV300	240	C02025	52	C02814	53
B74269LF	150	BWV400	240	C02025B	52	C02815	53
B74284LF	151	C001WD00	382	C02029	52	C02820	53
B74285LF	151	C001WD01	382	C02029B	52	C02821	53
B74286LF	151	C002WD00	382	C02030	52	C02822	53
B74287LF	151	C002WD01	382	C02030B	52	C02823	53
B74288LF	151	C01001	246	C02031	52	C02824	53
B74289LF	151	C01002	246	C02031B	52	C02825	53
B74301LF	151	C013WD00	381	C02032	52	C02830	53
B74302LF	151	C013WD00CH	382	C02032B	52	C02832	53
B74303LF	151	C013WD00INT	382	C02033	52	C02850	53
B74304LF	151	C013WD01	381	C02033B	52	C02851	53
B74305LF	151	C013WD02	381	C02034	52	C02852	53, 55
B74306LF	151	C013WD03	381	C02034B	52	C02860	53
B74331LF	151	C013WD04	381	C02040	53	C02861	53
B74343LF	150	C013WDO00	382	C02041	53	C02862	53
B74344LF	150	C013WDS00	382	C02045	53	C02863	53
B74345LF	150	C014WD00	381	C02046	53	C02864	53
B74347LF	150	C014WD00BN	382	C02050	51	C02865	53
B74354LF	150	C014WD00CH	382	C02075	54	C02900	53
B74358LF	150	C014WD01	381	C02100	53	C02901	53
B74359LF	150	C014WD02	381	C02103	53	C02987	53
B74365LF	150	C014WD03	381	C02104	53	C02989	53
B74367LF	150	C014WD04	381	C02105	53	C02990	51
B74368LF	150	C014WD20	381	C02106	53	C02992	53
B74369LF	150	C014WD30	381	C02200	54	C02993	53
B74370LF	151	C014WD40	381	C02201	54	C02994	53
B74380LF	150	C014WD45	381	C02202	54	C02995	53
B74381	150	C014WD50	381	C02203	54	C02996	53
B74382	150	C014WD53	381	C02210	54	C02997	53
B74384	150	C014WD58	381	C02211	54	C02998	53
B74396LF	150	C014WD80	381	C02300	54	C02999	53
B90050	167	C014WD90	381	C02301	54	C03200	54

PART NO.	PG #	PART NO.	PG #	PART NO.	PG #	PART NO.	PG #
C03201	54	C05046	48	C106SSCAM90	387	C1756C	37,79
C03202	54	C05047	48	C106SSCAMFRO	387	C1756H	37,79
C03203	54	C05048	48	C108C00	386	C1757CH	37,79
C03210	54	C05049	48	C108SSC00	386	C1759D	37,79
C03211	54	C05051	48	C108SSCAM00	386	C1807A	37,79
C03212	54	C05052	49	C11050	95	C1809A	37,79
C03213	54	C05053	49	C11075	95	C19050	96
C03240	54	C05054	49	C110C00	386	C19051	96
C03250	54	C05056	48	C11100	95	C19075	96
C03251	54	C05057	48	C11125	95	C200HEX	390
C03252	54	C05070	49	C11150	95	C200HPSS	390
C03253	54	C05071	49	C11200	95	C220000	384
C03260	54	C05080	70	C11250	95	C2200HPSS00	388
C03265	54	C05081	70	C11300	95	C2200HPSS90	388
C03270	54	C05082	70	C11400	95	C2200HPSSAMF	388
C03271	54	C05085	49	C12050	95	C2200O00	388
C03272	54	C05086	49	C12075	95	C2200OS00	389
C03280	54	C050WD00	382	C12100	95	C2200OS00HPSSAM	389
C03300	55	C05200	49	C1210S00	384	C2200S00	384
C03301	55	C06001	5	C1210S01	384	C2200S01	384
C03302	55	C06002	5	C1210S02	384	C2200S02	384
C03303	55	C06004	5	C1211S00	384	C2200S03	384
C03304	55	C06006	5	C1211S01	384	C2200S04	384
C03305	55	C06007	5	C1211S02	384	C2200S30	384
C03306	55	C06008	5	C12125	95	C2200S40	384
C03800	55	C06011	5	C12150	95	C2200S45	384
C03801	55	C06013	5	C12200	95	C2200S58	384
C03803	55	C06014	5	C12250	95	C2200S90	384
C03804	55	C06016	5	C12300	95	C25000	104
C03805	55	C06018	5	C12400	95	C25001	104
C03807	55	C06020	5	C12600	95	C25002	104
C03810	55	C06021	5	C13050	96	C25003	104
C04000	46	C06024	5	C13075	96	C25010	104
C04001	46	C09000	124	C14205	95	C25011	104
C04002	46	C09001	124	C14206	95	C25012	104
C04004	46	C09002	124	C14207	95	C25013	104
C04004	418	C09003	124	C15300	95	C25020	104
C04005	46	C1007S00	385	C15301	95	C25021	104
C04006	46	C100BBSSCAM0	388	C15302	95	C25022	104
C04007	46	C101000	386	C15303	95	C27125	47
C04008	46	C101001	386	C15304	95	C27126	47
C04010	46	C101002	386	C15305	95	C27127	47
C04011	46	C1010TK00	386	C15306	95	C27134	47
C04013	47	C101100	386	C15307	95	C27150	47
C04014	46	C101101	386	C160600	384	C27150A	47
C04015	47	C101102	386	C1606HPSS00	388	C27200	47
C04016	46	C1011TK00	386	C1606OS00	389	C27201	47
C04017	47	C102C00	389	C1606S00	384	C27202	47
C04019	45	C104100	384	C1606S01	384	C27301	47
C04020	45	C104101	384	C1606S02	384	C27302	47
C04021	45	C104102	384	C1606S03	384	C27303	47
C04024	46	C104200	384	C1606S04	384	C27304	47
C04025	46	C104201	384	C1606S30	384	C27305	47
C04027	47	C104202	384	C1606S40	384	C27308	47
C04028	46	C1042O00	384	C1606S45	384	C27309	47
C04029	46	C105000	385	C1606S58	384	C27310	47
C04030	45	C1050S00	385	C1606S90	384	C27321	48
C04031	45	C1050S01	385	C17050	96	C27322	48
C04032	47	C105SSC00	387	C17075	96	C27323	48
C04033	47	C105SSC90	387	C17100	96	C27324	48
C04034	47	C106C00	387	C17125	96	C27325	48
C04038	47	C106C90	387	C17150	96	C27328	48
C04039	47	C106CEZ00	387	C17200	96	C29123	125
C049WD00	382	C106CHPM00	388	C1740CH	37,79	C29124	125
C05040	46	C106SSC00	387	C1742C	37,79	C29126	124
C05041	46	C106SSC01	387	C1742H	37,79	C29150	124
C05042	49	C106SSC90	387	C1744D	37,79	C29200	124
C05045	48	C106SSCAM00	387	C1754CH	37,79	C2B1E16BN	383

PART NO.	PG #	PART NO.	PG #	PART NO.	PG #	PART NO.	PG #
C2B1E16BR	383	C33322	262	C38204	261	C3B5E200CH	390
C2B1E16CH	383	C33323	262	C38205	261	C3B5E201	390
C2B1E17BN	383	C33331	262	C38206	261	C3B5R200	390
C2B1E17BR	383	C33332	262	C38214	261	C3B5R200CH	390
C2B1E17CH	383	C33333	262	C384	37, 77	C3B5R201	390
C2B1E18BN	383	C33344	262	C38402	260	C3B5R221	390
C2B1E18CH	383	C33345	262	C38403	260	C3B5R242	390
C2B1E19BN	383	C33346	262	C38404	260	C3B5R260	390
C2B1E19CH	383	C33444	262	C38502	260	C3B5R270	390
C2B1ES19CH	383	C33445	262	C38503	260	C40002	261
C2B1R16BN	383	C33446	262	C38504	260	C40003	261
C2B1R16BR	383	C33544	262	C39002	261	C40004	261
C2B1R16CH	383	C33545	262	C39003	261	C40006	261
C2B1R17BN	383	C33546	262	C39004	261	C40102	260
C2B1R17BR	383	C35090	298, 405	C39005	261	C40103	260
C2B1R17CH	383	C35090	421	C39006	261	C40104	260
C2B1R18BN	383	C35091	298	C39014	261	C40320	245
C2B1R18CH	383	C35092	298, 405	C39102	261	C40420	245
C2B1R19BN	383	C35092	421	C39103	261	C40425	245
C2B1R19CH	383	C36003	260	C39104	261	C40430	245
C2B1RS19CH	383	C36004	260	C39114	261	C40440	245
C2B6R9AQCH	390	C36006	260	C39202	261	C40500	245
C2B6R9SHCH	390	C36013	260	C39203	261	C40503	245
C30050	168	C36014	260	C39204	261	C406	37, 77
C30075	168	C36016	260	C39205	261	C40640	246
C30100	168	C36024	260	C39206	261	C406A	37, 77
C30125	168	C36034	260	C39214	261	C406SSCHPSS00	390
C30150	168	C36104	260	C39402	260	C41410	245
C30200	168	C36106	260	C39403	260	C41411	245
C306CHPSS00	390	C36114	260	C39404	260	C41420	245
C31050	168	C36116	260	C39502	260	C41421	245
C31075	168	C36124	260	C39503	260	C41430	245
C31100	168	C36134	260	C39504	260	C41440	245
C31125	168	C37002	264	C3B2E115BN	383	C41460	245
C31150	168	C37003	264	C3B2E117BN	383	C42421	245
C31200	168	C37004	264	C3B2E117BR	383	C42440	245
C33001	263	C37005	264	C3B2E118BN	383	C42460	245
C33002	263	C37006	264	C3B2E118CH	383	C43440	246
C33003	263	C37014	264	C3B2E220BN	383	C43441	246
C33004	263	C37102	264	C3B2R117BN	383	C44420	246
C33005	263	C37103	264	C3B2R117BR	383	C44440	246
C33006	263	C37104	264	C3B2R117CH	383	C45433	245
C33021	262	C37302	264	C3B2R118BN	383	C46331	245
C33022	262	C37303	264	C3B2R118CH	383	C46351	245
C33023	262	C37304	264	C3B2R220BN	383	C46431	245
C33031	262	C37314	264	C3B3E200	385	C46451	245
C33032	262	C37800	236, 265	C3B3EJS00	385	C47320	245
C33033	262	C37801	236, 265	C3B3ESL00	384	C4733A	181
C33044	262	C37803	236, 265	C3B3R200	385	C4733P	181
C33045	262	C37805	237, 265	C3B3RSL00	384	C47340	245
C33046	262	C37806	237, 265	C3B4E290CH	382	C47420	245
C33088	263	C37807	237, 265	C3B4E2S00	381	C47430	245
C33121	262	C37808	237, 265	C3B4E300AMBN	381	C4743A	181
C33122	262	C37810	237, 265	C3B4R201BN	382	C4743P	181
C33123	262	C37811	237, 265	C3B4R220	381	C47440	245
C33144	262	C38002	261	C3B4R230	381	C47460	245
C33145	262	C38003	261	C3B4R240	381	C49421	246
C33146	262	C38004	261	C3B4R245	381	C49440	246
C33221	262	C38005	261	C3B4R250	381	C49441	246
C33222	262	C38006	261	C3B4R253	381	C49442	246
C33223	262	C38014	261	C3B4R258	381	C50300	180
C33231	262	C38102	261	C3B4R280	381	C50301	180
C33232	262	C38103	261	C3B4R290	381	C50302	181
C33233	262	C38104	261	C3B4R290CH	382	C50303	181
C33244	262	C38114	261	C3B4R300AMAB	381	C50304	181
C33245	262	C382	37, 77	C3B4R300AMBN	381	C50305	181
C33246	262	C38202	261	C3B4R400CH	382	C50306	181
C33321	262	C38203	261	C3B5E200	390	C50307	181

PART NO.	PG #	PART NO.	PG #	PART NO.	PG #	PART NO.	PG #
C50308	181	C58045	181	C59103	235	C60051	233
C50309	181	C58134	180	C59200	232	C60052	233
C50340	180	C58140	180	C59201	232	C60053	233
C50341	180	C58234	180	C59202	232	C60054	234
C50345	180	C58236	180	C59203	232	C60055	234
C50346	180	C58334	180	C59204	232	C60056	234
C50400	180	C58434	182	C59205	232	C60057	234
C51150	182	C59001	232	C59206	232	C60060	231
C51300	180	C59002	232	C59207	232	C60061	231
C51301	180	C59003	232	C59208	233	C60062	231
C51302	183	C59004	232	C59209	233	C60063	231
C51303	183	C59005	232	C59210	233	C60064	231
C51340	180	C59006	232	C59211	233	C60065	231
C51341	180	C59007	232	C59212	233	C60066	231
C51350	181	C59008	232	C59213	233	C60067	231
C51351	181	C59010	233	C59214	233	C60070	234
C51400	180	C59011	233	C59215	233	C60071	234
C51401	180	C59012	233	C59216	233	C60072	234
C51402	183	C59013	233	C59217	233	C60073	234
C51403	183	C59014	233	C59218	233	C60075	234
C51450	181	C59015	233	C59219	233	C60076	234
C51451	181	C59016	233	C59220	233	C60077	234
C52150	182	C59017	233	C59221	233	C60078	234
C52340	180	C59020	235	C59222	233	C60079	234
C52341	180	C59021	235	C59223	233	C60080	234
C52342	182	C59022	235	C59240	190	C60081	234
C52343	182	C59023	235	C59241	190	C60082	234
C52345	180	C59024	235	C59242	190	C60083	234
C52346	180	C59025	235	C59244	190	C60084	234
C52400	180	C59026	235	C59245	190	C60085	234
C52401	180	C59027	235	C59250	190	C60086	234
C52402	182	C59028	235	C59251	190	C60087	234
C52403	182	C59029	235	C59252	190	C60088	234
C53340	180	C59030	235	C60001	233	C60089	234
C53341	180	C59031	235	C60003	233	C60092	234
C53342	182	C59050	232	C60007	229	C60094	234
C53343	182	C59051	232	C60008	229	C60095	234
C53400	180	C59052	232	C60009	229	C60096	234
C53401	180	C59053	232	C60010	229	C60097	234
C53402	182	C59054	233	C60011	229	C60106	229
C53403	182	C59055	233	C60012	229	C60107	229
C53600	181	C59056	233	C60013	231	C60108	229
C53601	181	C59057	233	C60014	231	C60112	229
C53700	181	C59060	232	C60015	231	C60116	229
C53701	181	C59061	232	C60016	231	C60117	229
C54150	181	C59062	232	C60020	233	C60118	229
C54340	182	C59063	232	C60021	233	C60140	230
C54341	182	C59064	233	C60022	233	C60141	230
C54342	182	C59065	233	C60023	233	C60142	230
C54343	182	C59066	233	C60024	233	C60143	230
C54400	182	C59067	233	C60025	233	C60144	230
C54401	182	C59068	233	C60026	234	C60145	230
C54402	182	C59069	233	C60027	234	C60146	230
C54403	182	C59070	233	C60028	234	C60147	230
C55043	182	C59071	233	C60029	234	C60160	230
C55143	182	C59090	235	C60030	234	C60161	230
C56100	127	C59091	235	C60031	234	C60162	230
C57034	180	C59092	235	C60032	234	C60163	230
C57040	180	C59093	235	C60033	234	C60164	230
C57045	181	C59094	235	C60040	231	C60165	230
C57134	180	C59095	235	C60041	231	C60166	230
C57140	180	C59096	235	C60042	231	C60167	230
C57234	180	C59097	235	C60043	231	C60170	228
C57236	180	C59098	235	C60044	231	C60171	228
C57334	180	C59099	235	C60045	231	C60172	228
C57434	182	C59100	235	C60046	231	C60207	229
C58034	180	C59101	235	C60047	231	C60211	229
C58040	180	C59102	235	C60050	233	C60500	237

PART NO.	PG #	PART NO.	PG #	PART NO.	PG #	PART NO.	PG #
C60501	237	C72002	259	C74067LF	136	C75023	365
C60502	237	C72003	259	C74068LF	136	C75024	365
C60503	237	C72004	259	C74069LF	136	C75025	365
C60504	237	C72093	259	C74070LF	136	C75026	365
C60505	237	C73003	258	C74071LF	136	C75027	365
C60800	221	C73004	258	C74072LF	136	C75028	365
C60801	221	C73093	258	C74073LF	136	C75029	365
C60802	221	C73094	258	C74078LF	136	C75030	365
C60803	21, 221	C73192	258	C74081LF	136	C75031	365
C60804	21, 221	C73193	258	C74082LF	136	C75033	365
C60805	221	C74001LF	135	C74085LF	136	C75034	365
C60806	21, 221	C74002LF	135	C74086LF	136	C75035	365
C60807	21, 221	C74003	135	C74087LF	136	C75036	365
C60808	221	C74004	135	C74088LF	136	C75037	365
C60809	221	C74005	135	C74089LF	136	C75038	365
C60810	21, 221	C74006	135	C74090LF	136	C75039	366
C60811	221	C74007	135	C74091LF	135	C75040	366
C60812	221	C74008	135	C74093LF	135	C75041	366
C60813	21, 221	C74009	135	C74095	136	C75042	366
C60814	21, 221	C74010	135	C74096	135	C75043	366
C60817	221	C74011	135	C74097	135	C75044	366
C60818	221	C74012	135	C74098	135	C75045	366
C60819	221	C74013	135	C74099	135	C75046	366
C60820	221	C74014	135	C74100LF	135	C75047	366
C60821	221	C74015	135	C74101LF	135	C75048	366
C60822	221	C74016	135	C74102LF	135	C75049	366
C60823	221	C74017	135	C74103LF	135	C75050	366
C60824	221	C74018	135	C74105	72, 324	C75051	366
C60825	221	C74019	135	C74112LF	136	C75052	366
C6083BN	21	C74020	135	C74113LF	135	C75053	366
C6083RB	21	C74021LF	135	C74114LF	135	C75055	365
C6083WB	21	C74022LF	135	C74118LF	135	C75056	365
C6084BN	21	C74023LF	135	C74121LF	136	C75057	365
C6084RB	21	C74025LF	135	C74123LF	136	C75058	365
C6084WB	21	C74026LF	135	C74131LF	136	C75059	365
C6087BN	21	C74027LF	135	C74135LF	136	C75060	365
C6087RB	21	C74029LF	135	C74136LF	136	C75061	365
C6087WB	21	C74030LF	135	C74146LF	136	C75062	365
C60888	21, 221	C74031LF	135	C74147LF	135	C75063	365
C6088BN	21	C74032LF	135	C74149LF	136	C75064	365
C6088RB	21	C74033LF	135	C74152	135	C75065	365
C6088WB	21	C74034LF	135	C74155LF	135	C75066	365
C6089AB	21	C74036LF	135	C74158LF	136	C75067	365
C6089AL	21	C74037LF	135	C74250LF	84	C75068	365
C6089AN	21	C74038LF	135	C74251LF	84	C75069	364
C6089BI	21	C74039LF	135	C75000	364	C75070	364
C6089BL	21	C74040LF	136	C75001	364	C75071	364
C6089BN	21	C74041LF	136	C75002	364	C75073	364
C6089PN	21	C74042LF	136	C75003	364	C75074	364
C6089PS	21	C74043LF	136	C75004	364	C75075	364
C6089PW	21	C74044LF	136	C75005	364	C75076	364
C6089RB	21	C74045LF	135	C75006	364	C75077	364
C6089WB	21	C74046LF	135	C75007	364	C75078	364
C61009	230	C74048LF	135	C75008	364	C75079	364
C61023	230	C74049LF	135	C75009	364	C75080	364
C61034	230	C74050LF	135	C75010	364	C75081	364
C61123	230	C74051LF	135	C75011	364	C75082	364
C61134	230	C74052LF	135	C75012	364	C75083	364
C61223	230	C74053LF	135	C75013	364	C75084	364
C61234	230	C74054LF	135	C75014	365	C75085	364
C61432	230	C74055LF	135	C75015	365	C75086	364
C61434	230	C74058LF	136	C75016	365	C75087	364
C67230	241	C74059LF	136	C75017	365	C75088	364
C67340	241	C74060LF	136	C75018	365	C75089	364
C67440	241	C74063LF	136	C75019	365	C75090	364
C67445	241	C74064LF	136	C75020	365	C75091	364
C67450	231	C74065LF	136	C75021	365	C75092	364
C67451	231	C74066LF	136	C75022	365	C75093	364

<u>PART NO.</u>	<u>PG #</u>	<u>PART NO.</u>	<u>PG #</u>	<u>PART NO.</u>	<u>PG #</u>	<u>PART NO.</u>	<u>PG #</u>
C75094	364	C75163	368	C75238	368	C75312	363
C75095	364	C75166	368	C75239	368	C75313	363
C75096	364	C75167	368	C75240	368	C75314	363
C75097	364	C75168	368	C75242	368	C75315	363
C75098	364	C75169	368	C75243	368	C75316	363
C75099	364	C75170	368	C75244	368	C75317	363
C75100	364	C75171	368	C75245	368	C75318	363
C75101	364	C75173	368	C75246	368	C75319	363
C75102	364	C75174	368	C75247	368	C75320	363
C75103	364	C75175	368	C75248	368	C75321	363
C75104	364	C75176	368	C75249	368	C75322	363
C75105	364	C75177	368	C75250	368	C75323	363
C75106	364	C75178	368	C75251	368	C75324	363
C75107	364	C75181	368	C75252	368	C75325	363
C75108	364	C75182	368	C75253	368	C75326	363
C75109	364	C75183	368	C75254	368	C75327	363
C75110	364	C75184	368	C75255	368	C75328	363
C75111	363	C75185	368	C75256	368	C75329	363
C75112	363	C75186	368	C75257	368	C75330	363
C75113	363	C75188	368	C75258	368	C75331	363
C75114	363	C75189	368	C75259	368	C75332	363
C75115	363	C75190	368	C75260	368	C75334	363
C75116	363	C75191	368	C75261	369	C75335	363
C75117	363	C75192	368	C75262	369	C75336	363
C75118	363	C75193	368	C75263	369	C75337	363
C75119	363	C75194	368	C75264	369	C75338	363
C75120	363	C75195	368	C75265	369	C75339	363
C75121	363	C75196	368	C75266	369	C75340	363
C75122	363	C75197	368	C75267	369	C75341	363
C75123	363	C75198	368	C75268	369	C75342	363
C75124	363	C75199	368	C75269	369	C75343	363
C75125	363	C75200	368	C75270	369	C75345	363
C75126	363	C75202	368	C75271	369	C75346	363
C75127	363	C75203	368	C75272	369	C75347	363
C75128	363	C75204	368	C75273	369	C75348	363
C75129	363	C75205	368	C75274	369	C75349	363
C75130	363	C75206	368	C75275	369	C75350	363
C75131	363	C75207	368	C75276	369	C75352	363
C75132	363	C75208	368	C75277	369	C75353	363
C75133	363	C75209	368	C75281	369	C75354	363
C75134	363	C75210	368	C75282	369	C75355	363
C75135	363	C75211	368	C75283	369	C75356	363
C75136	363	C75212	368	C75285	369	C75357	363
C75137	363	C75213	368	C75286	369	C75358	363
C75138	363	C75214	368	C75288	369	C75359	363
C75139	363	C75215	368	C75289	369	C75360	366
C75140	363	C75216	368	C75290	369	C75361	366
C75141	363	C75217	368	C75291	369	C75362	366
C75142	363	C75218	368	C75292	369	C75363	366
C75143	368	C75219	368	C75293	369	C75366	366
C75144	368	C75220	368	C75294	369	C75367	366
C75145	368	C75221	368	C75295	369	C75368	366
C75146	368	C75222	368	C75296	369	C75370	366
C75147	368	C75223	368	C75297	369	C75371	366
C75148	368	C75224	368	C75298	369	C75372	366
C75149	368	C75225	368	C75299	369	C75373	366
C75150	368	C75226	368	C75300	369	C75374	366
C75151	368	C75227	368	C75301	369	C75375	363
C75152	368	C75228	368	C75302	369	C75377	365
C75153	368	C75229	368	C75303	369	C75378	365
C75154	369	C75230	368	C75304	369	C75379	365
C75155	369	C75231	368	C75305	369	C75380	365
C75156	369	C75232	368	C75306	369	C75381	365
C75157	369	C75233	368	C75307	369	C75382	365
C75158	369	C75234	368	C75308	369	C75383	365
C75160	368	C75235	368	C75309	369	C75384	365
C75161	368	C75236	368	C75310	369	C75385	365
C75162	368	C75237	368	C75311	363	C75386	365

<u>PART NO.</u>	<u>PG #</u>	<u>PART NO.</u>	<u>PG #</u>	<u>PART NO.</u>	<u>PG #</u>	<u>PART NO.</u>	<u>PG #</u>
C75387	365	C75462	367	C75574	369	C76506LF	145
C75388	365	C75463	366	C75576	369	C76507LF	145
C75392	363	C75464	366	C75577	369	C76508LF	145
C75394	363	C75465	366	C75578	369	C76509LF	145
C75395	363	C75466	366	C75579	369	C76510LF	145
C75396	363	C75467	366	C75580	364	C76511LF	145
C75397	363	C75468	366	C75581	364	C76512LF	145
C75398	363	C75469	366	C75582	364	C76513LF	145
C75399	363	C75470	366	C75583	364	C76514LF	145
C75400	363	C75471	366	C75586	364	C76515LF	145
C75401	363	C75472	366	C76001LF	142	C76516LF	145
C75403	366	C75473	366	C76002LF	142	C76520	145
C75404	366	C75474	366	C76003LF	142	C76521	145
C75405	366	C75477	364	C76004LF	142	C76522	145
C75406	366	C75478	364	C76005LF	142	C76530LF	145
C75407	366	C75479	366	C76008LF	142	C76531LF	145
C75408	366	C75481	365	C76009LF	142	C76532LF	145
C75409	366	C75482	365	C76010LF	142	C76553LF	145
C75410	366	C75483	365	C76013LF	142	C76561LF	145
C75411	366	C75484	365	C76014LF	142	C76562LF	145
C75412	364	C75485	365	C76015LF	142	C76570LF	145
C75413	364	C75486	365	C76016LF	142	C76571LF	145
C75414	364	C75487	365	C76017LF	142	C76605LF	113, 145
C75415	364	C75488	365	C76018LF	142	C76606LF	113, 145
C75416	364	C75489	365	C76019LF	142	C76607LF	113, 145
C75417	364	C75490	365	C76020LF	142	C76608LF	113, 145
C75418	364	C75491	365	C76021LF	142	C76612LF	113, 145
C75419	364	C75492	365	C76022LF	142	C76613LF	113, 145
C75420	364	C75494	363	C76023LF	142	C76614LF	113, 145
C75421	364	C75502	367	C76027LF	142	C76615LF	113, 145
C75422	364	C75503	367	C76028LF	142	C76616LF	113, 145
C75423	364	C75504	367	C76029LF	142	C76617LF	113, 145
C75424	364	C75505	367	C76030LF	142	C76700	143
C75425	367	C75506	367	C76034LF	142	C76701	143
C75427	367	C75507	367	C76035LF	142	C76702	143
C75428	367	C75508	367	C76036LF	142	C76703	143
C75429	367	C75509	367	C76037LF	142	C76704	143
C75430	367	C75516	364	C76038LF	142	C76705	143
C75431	367	C75517	364	C76041LF	142	C76706	143
C75432	367	C75519	364	C76042LF	142	C76707	143
C75433	367	C75522	365	C76043LF	142	C76708	143
C75434	367	C75523	365	C76044LF	142	C76709	143
C75435	367	C75525	366	C76047LF	142	C76710	143
C75437	367	C75527	366	C76048LF	142	C76711	143
C75438	367	C75535	365	C76049LF	142	C76712	143
C75439	367	C75536	365	C76050LF	142	C76720	143
C75440	367	C75540	365	C76051LF	142	C76722	143
C75441	367	C75544	365	C76060LF	142	C76723	143
C75442	367	C75546	366	C76065LF	142	C76727	143
C75443	367	C75548	364	C76066LF	142	C76740	143
C75444	367	C75550	364	C76067LF	142	C76741	143
C75445	367	C75551	364	C76070	143	C76751	144
C75446	367	C75553	364	C76071	143	C76752	144
C75447	367	C75554	364	C76072	143	C76753	144
C75448	367	C75555	364	C76073	143	C76754	144
C75449	367	C75556	364	C76074	143	C76755	144
C75450	367	C75557	364	C76075	143	C76756	144
C75451	367	C75558	364	C76076	143	C76757	144
C75452	367	C75559	364	C76077	143	C76758	144
C75453	367	C75562	367	C76079LF	143	C76759	144
C75454	367	C75563	367	C76080LF	143	C76760	144
C75455	367	C75564	364	C76081LF	143	C76761	144
C75456	367	C75565	364	C76500LF	145	C76762	144
C75457	367	C75566	364	C76501LF	145	C76763	144
C75458	367	C75568	366	C76502LF	145	C76764	144
C75459	367	C75571	368	C76503LF	145	C76765	144
C75460	367	C75572	368	C76504LF	145	C76766	144
C75461	367	C75573	369	C76505LF	145	C76767	144

<u>PART NO.</u>	<u>PG #</u>	<u>PART NO.</u>	<u>PG #</u>	<u>PART NO.</u>	<u>PG #</u>	<u>PART NO.</u>	<u>PG #</u>
C76768	144	C76859	147	C77054	370	C77138	372
C76769	144	C76860	147	C77055	370	C77139	372
C76770	144	C76861	147	C77056	370	C77140	372
C76771	144	C76862	147	C77057	370	C77141	372
C76772	144	C76863	147	C77058	370	C77142	372
C76773	144	C76864	147	C77059	370	C77143	372
C76774	144	C76865	147	C77060	370	C77144	372
C76775	144	C76866	147	C77061	370	C77145	372
C76776	144	C76867	147	C77062	370	C77146	372
C76800	146	C76868	147	C77063	370	C77149	371
C76801	146	C76869	147	C77064	370	C77150	371
C76802	146	C76870	147	C77065	370	C77151	371
C76803	146	C76871	147	C77066	370	C77152	371
C76804	146	C76872	147	C77067	370	C77153	371
C76805	146	C76873	147	C77068	370	C77154	371
C76806	146	C76874	147	C77069	370	C77155	371
C76807	146	C76875	147	C77070	370	C77159	371
C76808	146	C76876	147	C77071	371	C77162	371
C76809	146	C76877	147	C77072	371	C77165	371
C76810	146	C76878	147	C77073	371	C77166	371
C76811	146	C76879	147	C77074	371	C77167	371
C76812	146	C76880	147	C77075	371	C77168	371
C76813	146	C76881	147	C77076	371	C77169	371
C76814	146	C76882	147	C77077	371	C77170	371
C76815	146	C76883	147	C77078	371	C77173	371
C76816	146	C76884	147	C77079	371	C77174	371
C76817	146	C76885	147	C77080	372	C77175	371
C76818	146	C76886	147	C77081	372	C77176	371
C76819	146	C76887	147	C77082	372	C77177	371
C76820	146	C76888	147	C77083	372	C77178	371
C76821	146	C76889	147	C77084	372	C77179	371
C76822	146	C76890	147	C77085	372	C77180	371
C76823	146	C76891	147	C77086	372	C77181	371
C76824	146	C76892	147	C77087	372	C77182	371
C76825	146	C76893	147	C77088	372	C77183	371
C76826	146	C77001	370	C77091	372	C77185	371
C76827	146	C77002	370	C77092	372	C77186	371
C76828	146	C77003	370	C77093	372	C77187	371
C76829	146	C77004	370	C77094	372	C77188	371
C76830	146	C77005	370	C77095	372	C77189	371
C76831	146	C77006	370	C77096	372	C77190	371
C76832	146	C77007	370	C77097	372	C77191	371
C76833	146	C77008	370	C77098	372	C77192	371
C76834	146	C77009	370	C77099	372	C77193	371
C76835	146	C77010	370	C77100	372	C77194	371
C76836	146	C77011	370	C77101	372	C77195	371
C76837	146	C77012	370	C77102	372	C77196	371
C76838	146	C77013	370	C77103	372	C77199	371
C76839	146	C77014	370	C77104	372	C77218	371
C76840	147	C77015	370	C77105	372	C77219	371
C76841	147	C77016	370	C77106	372	C77220	371
C76842	147	C77017	370	C77107	372	C77221	371
C76843	147	C77018	370	C77108	372	C77222	371
C76844	147	C77019	370	C77109	372	C77223	371
C76845	147	C77020	370	C77110	372	C77224	371
C76846	147	C77021	370	C77113	372	C77225	371
C76847	147	C77022	370	C77114	372	C77226	371
C76848	147	C77023	370	C77115	372	C801800	389
C76849	147	C77044	370	C77116	372	C8019S00	387
C76850	147	C77045	370	C77117	372	C803200	385
C76851	147	C77046	370	C77118	372	C803201	385
C76852	147	C77047	370	C77131	372	C8032O00	389
C76853	147	C77048	370	C77132	372	C803300	385
C76854	147	C77049	370	C77133	372	C803301	385
C76855	147	C77050	370	C77134	372	C8033O00	389
C76856	147	C77051	370	C77135	372	C85000	246
C76857	147	C77052	370	C77136	372	C85000	183
C76858	147	C77053	370	C77137	372	C85000	418

PART NO.	PG #	PART NO.	PG #	PART NO.	PG #	PART NO.	PG #
C85500	246	C93500	267	D01016	11, 60	D04053	102
C87100	246	C94004	268	D01017	11, 60	D04054	102
C87100	184, 418	C94005	268	D01018	11, 60	D04055	102
C88001	183	C94007	268	D01020	11, 60	D04056	102
C88002	183	C94009	268	D01021	11, 60	D04057	102
C88050	184	C95004	268	D01022	60	D04058	102
C88500	183	C95005	268	D01023	60	D04059	102
C88500C	184	C95007	268	D01024	11, 59	D04060	102
C88501	183	C95009	268	D01025	11, 59	D04062	102
C88502	183	C96004	268	D01026	11, 60	D06005	112
C88600	183	C96005	268	D01027	11, 60	D06050	112
C90002	268	C96007	268	D01028	60	D06075	112
C90004	268	C96009	268	D01029	60	D06100	112
C90006	268	C97004	268	D01030	11, 60	D06125	112
C90013	268	C97005	268	D01031	11, 60	D06150	112
C90014	268	C97007	268	D01032	11, 59	D06200	112
C90015	268	C97009	268	D01040	59	D06250	112
C90016	268	C98001	124, 268	D01041	59	D06300	112
C90017	268	C98002	124, 268	D01042	59	D06350	112
C90018	268	C98014	268	D0104BN	11	D06400	112
C90019	268	C98016	268	D0104RB	11	D06450	113
C90300	268	C98018	268	D0104WB	11	D06500	113
C90400	268	CB05	357	D01050	11	D06510	113
C90500	268	CB07	357	D01050BN	11	D06525	113
C90600	268	CB10	357	D01050RB	11	D06550	113
C90700	268	CB12	357	D01050WB	11	D06600	113
C90800	268	CB15	357	D02001	124	D06650	113
C90999	268	CB2001	51	D02002	70, 124	D06700	113
C91013	268	CB2002	51	D03001	10	D06750	112
C91014	268	CB2003	51	D03002	10	D06753	113
C91015	268	CB2004	51	D03004	10	D06755	112
C91016	268	CB2005	51	D03010	10	D06800	113
C91017	268	CB2011	51	D03011	10	D06801	113
C91018	268	CB2012	51	D03015	10	D06802	113
C91019	268	CB2013	51	D03016	10	D06803	113
C91300	268	CB2014	51	D03020	10	D06804	113
C91400	268	CB2015	51	D04001	102	D06805	113
C91500	268	CB2021	51	D04002	102	D06850	113
C91600	268	CB2022	51	D04003	102	D06875	113
C91700	268	CB2023	51	D04004	102	D06900	113
C91800	268	CB2024	51	D04005	102	D06901	113
C91999	268	CB2025	51	D04008	102	D06902	113
C92150	267	CB2030	51	D04009	102	D06903	113
C92151	267	CB2031	51	D04010	102	D08001	99
C92200	267	CB2032	51	D04012	101	D10001	101
C92202	267	CB2033	51	D04013	102	D10625	101
C92250	267	CB2034	51	D04014	102	D10875	101
C92252	267	CB2040	53	D04015	102	D10900	101
C92300	267	CB2041	53	D04016	102	D18000	98, 395
C92301	267	CB2045	53	D04017	102	D18001	98, 395
C92303	267	CB2046	53	D04018	102	D18002	98, 395
C92350	267	CG05	357	D04020	102	D18020	98, 395
C92351	267	CG07	357	D04021	102	D18021	98, 395
C92353	267	CG10	357	D04022	102	D18022	98, 395
C92400	267	CJ1002	103	D04023	101	D18034	98
C92404	267	CJ1003	51	D04024	101	D18050	301
C92500	267	CZPP100	402	D04025	101	D18051	301
C92600	267	CZPP200	402	D04026	101	D18052	301
C92601	267	D01001	60	D04027	102	D18060	98
C92800	267	D01002	60	D04028	102	D18062	76
C93150	267	D01003	60	D04031	102	D18063	76
C93200	267	D01004	60	D04032	102	D18186	98
C93250	267	D01005	61	D04033	102	D18190	301
C93300	267	D01008	60	D04034	102	D18340	98
C93301	267	D01009	60	D04035	102	D18400	98
C93350	267	D01010	11, 60	D04036	102	D18401	98
C93351	267	D01011	11, 60	D04050	102	D18501	98
C93400	267	D01015	11, 60	D04051	102	D18750	98

<u>PART NO.</u>	<u>PG #</u>
D18850	98
D28003	274
D28004	274
D40000	62, 248
D40001	62, 248
D40002	62, 248
D40003	21, 188
D40004	21, 188
D40005	21, 188
D40006	188
D40007	188
D40008	188
D40009	188
D40010	21, 188
D40020	226
D40021	226
D40023	226
D4005BN	21
D4005RB	21
D4005WB	21
D40101	188
D40102	259
D40103	259
D40104	259
D4010BN	20
D4010RB	20
D4010WB	20
D40140	188
D40151	188
D40200	259
D40201	188
D40202	259
D40203	259
D40204	259
D40240	188
D40401	188
D40440	188
D40600	227
D40601	227
D40602	227
D40700	227
D40701	227
D41001	188
D41002	188
D41003	188
D41004	188
D41007	188
D41008	188
D41009	188
D41101	22, 188
D41102	22, 188
D41103	188
D41104	188
D41105	188
D41107	22, 188
D4110BN	22
D4110PN	22
D4110RB	22
D4110WB	22
D41301	188
D41302	188
D41303	188
D41307	188
D41600	188
D41601	188
D42002	225
D42003	225
D42004	225

<u>PART NO.</u>	<u>PG #</u>
D42006	226
D42006H	227
D42007	226
D42007H	227
D42008	226
D42008H	227
D42009	226
D42009H	227
D42010	226
D42010H	227
D42011	226
D42012	226
D42013	226
D42014	226
D42015	226
D42019	226
D42022	225
D42023	225
D42024	225
D42029	226
D45000	75
D45001	75
D45002	259
D49001	198
D49002	198
D49003	198
D49004	198
D49005	198
D49006	198
D49007	198
D49008	198
D49009	198
D49010	198
D49011	198
D49012	198
D49013	198
D49014	198
D49019	198
D49020	198
D49021	198
D49022	198
D49023	199
D49024	199
D49025	199
D49026	199
D49027	199
D49028	199
D49029	199
D49030	199
D49031	199
D49032	199
D49033	199
D49034	199
D49035	199
D49036	199
D49037	199
D49038	199
D49039	199
D49040	199
D49041	199
D49042	199
D49043	199
D49044	199
D49045	199
D49046	199
D49047	199
D49048	199
D49049	199

<u>PART NO.</u>	<u>PG #</u>
D49050	199
D49051	199
D49052	199
D49053	199
D49054	199
D49055	20, 199
D49056	199
D49057	20, 199
D49058	199
D49059	20, 199
D49060	199
D49061	199
D49062	199
D49063	199
D49064	199
D49065	199
D49066	199
D49077	200
D49078	200
D49079	200
D49080	200
D49081	200
D49082	200
D49083	200
D49084	200
D49085	200
D49086	200
D49087	200
D49088	200
D49089	200
D49090	200
D49095	200
D49096	200
D49097	200
D49098	200
D49101	200
D49102	200
D49103	200
D49104	200
D49105	200
D49106	200
D49107	200
D49108	200
D49109	200
D49110	200
D49111	200
D49112	200
D49113	200
D49114	200
D49119	200
D49120	200
D49121	200
D49122	200
D49123	201
D49124	201
D49125	201
D49126	201
D49127	201
D49128	201
D49129	201
D4912BN	20
D4912RB	20
D4912WB	20
D49130	201
D49131	201
D49132	201
D49133	201
D49134	201

<u>PART NO.</u>	<u>PG #</u>
D49135	201
D49136	201
D49137	201
D49138	201
D49139	201
D49140	201
D49141	201
D49142	201
D49143	201
D49144	201
D49145	201
D49146	201
D49147	201
D49148	201
D49149	201
D49150	201
D49151	201
D49152	201
D49153	201
D49154	201
D49155	20, 201
D49156	201
D49157	20, 201
D49158	201
D49159	20, 201
D49160	201
D49161	201
D49162	201
D49163	201
D49164	201
D49165	201
D49166	201
D49177	202
D49178	202
D49179	202
D49180	202
D49181	202
D49182	202
D49183	202
D49184	202
D49185	202
D49186	202
D49187	202
D49188	202
D49189	202
D49190	202
D49195	202
D49196	202
D49197	202
D49198	202
D49201	202
D49202	202
D49203	202
D49204	202
D49205	202
D49206	202
D49207	202
D49208	202
D49209	202
D49210	202
D49211	202
D49212	202
D49213	202
D49214	202
D49219	202
D49220	202
D49221	202
D49222	202

<u>PART NO.</u>	<u>PG #</u>	<u>PART NO.</u>	<u>PG #</u>	<u>PART NO.</u>	<u>PG #</u>	<u>PART NO.</u>	<u>PG #</u>
D49223	203	D49307	205	D49390	207	D49469	208
D49224	203	D49308	205	D49395	207	D49470	208
D49225	203	D49309	205	D49396	207	D49473	208
D49226	203	D49310	205	D49397	207	D49474	208
D49227	203	D49311	205	D49398	207	D49475	208
D49228	203	D49312	205	D49401	207	D49476	208
D49229	203	D49313	205	D49402	207	D49477	209
D49230	203	D49314	205	D49403	207	D49478	209
D49231	203	D49319	205	D49404	207	D49479	209
D49232	203	D49320	205	D49405	207	D49480	209
D49233	203	D49321	205	D49406	207	D49481	209
D49234	203	D49322	205	D49407	207	D49482	209
D49235	203	D49323	206	D49408	207	D49483	209
D49236	203	D49324	206	D49410	207	D49484	209
D49237	203	D49325	206	D49411	207	D49485	209
D49238	203	D49326	206	D49412	207	D49486	209
D49239	203	D49327	206	D49413	207	D49487	209
D49240	203	D49328	206	D49414	207	D49488	209
D49241	203	D49329	206	D49419	207	D49489	209
D49242	203	D49330	206	D49420	207	D49490	209
D49243	203	D49331	206	D49421	207	D49495	209
D49244	203	D49332	206	D49422	207	D49496	209
D49245	203	D49333	206	D49423	208	D49497	209
D49246	203	D49334	206	D49424	208	D49498	209
D49247	203	D49335	206	D49425	208	D49501	209
D49248	203	D49336	206	D49426	208	D49502	209
D49249	203	D49337	206	D49427	208	D49503	209
D49250	203	D49338	206	D49428	208	D49504	209
D49251	203	D49339	206	D49429	208	D49505	209
D49252	203	D49340	206	D49430	208	D49506	209
D49253	203	D49341	206	D49431	208	D49507	209
D49254	203	D49342	206	D49432	208	D49508	209
D49255	203	D49343	206	D49433	208	D49509	209
D49256	203	D49344	206	D49434	208	D49510	209
D49257	203	D49345	206	D49435	208	D49511	209
D49258	203	D49346	206	D49436	208	D49512	209
D49259	203	D49348	206	D49437	208	D49513	209
D49260	203	D49349	206	D49438	208	D49514	209
D49261	203	D49350	206	D49439	208	D49519	209
D49262	203	D49351	206	D49440	208	D49520	209
D49263	203	D49352	206	D49441	208	D49521	209
D49264	203	D49353	206	D49442	208	D49522	209
D49265	203	D49354	206	D49443	208	D49523	210
D49266	203	D49355	206	D49444	208	D49524	210
D49277	204	D49356	206	D49445	208	D49525	210
D49278	204	D49357	206	D49446	208	D49526	210
D49279	204	D49358	206	D49447	208	D49527	210
D49280	204	D49359	206	D49448	208	D49528	210
D49281	204	D49360	206	D49449	208	D49529	210
D49282	204	D49361	206	D49450	208	D49530	210
D49283	204	D49362	206	D49451	208	D49531	210
D49284	204	D49363	206	D49452	208	D49532	210
D49285	204	D49364	206	D49453	208	D49533	210
D49286	204	D49365	206	D49454	208	D49534	210
D49287	204	D49366	206	D49455	208	D49535	210
D49288	204	D49377	207	D49456	208	D49536	210
D49289	204	D49378	207	D49457	208	D49537	210
D49290	204	D49379	207	D49458	208	D49538	210
D49295	204	D49380	207	D49459	208	D49539	210
D49296	204	D49381	207	D49460	208	D49540	210
D49297	204	D49382	207	D49461	208	D49541	210
D49298	204	D49383	207	D49462	208	D49542	210
D49301	205	D49384	207	D49463	208	D49543	210
D49302	205	D49385	207	D49464	208	D49544	210
D49303	205	D49386	207	D49465	208	D49545	210
D49304	205	D49387	207	D49466	208	D49546	210
D49305	205	D49388	207	D49467	208	D49547	210
D49306	205	D49389	207	D49468	208	D49548	210

<u>PART NO.</u>	<u>PG #</u>	<u>PART NO.</u>	<u>PG #</u>	<u>PART NO.</u>	<u>PG #</u>	<u>PART NO.</u>	<u>PG #</u>
D49549	210	D49808	218	D50027	213	D50182	225
D49550	210	D49810	218	D50028	213	D50183	225
D49551	210	D49811	218	D50037	212	D50184	225
D49552	210	D49812	218	D50038	214	D50185	225
D49553	210	D49813	218	D50039	215	D50186	225
D49554	210	D49814	218	D50041	214	D50187	225
D49555	210	D49815	218	D50044	212	D50188	225
D49556	210	D49816	218	D50045	214	D50200	227
D49557	210	D49817	218	D50046	215	D50201	227
D49558	210	D49818	218	D50047	212	D50202	227
D49559	210	D49820	224	D50048	214	D50204	227
D49560	210	D49821	224	D50049	215	D50205	227
D49561	210	D49822	224	D50050	212	D50206	227
D49562	210	D49823	224	D50051	214	D50207	227
D49563	210	D49824	224	D50052	215	D50208	227
D49564	210	D49825	224	D50053	212	D50213	227
D49565	210	D49826	224	D50054	214	D50220	227
D49566	210	D49827	224	D50060	213	D50221	227
D49577	211	D49828	224	D50061	214	D50278	212
D49578	211	D49829	224	D50062	216	D50279	214
D49579	211	D49830	224	D50063	213	D50280	215
D49580	211	D49831	224	D50064	214	D50301	185
D49581	211	D4984BN	20	D50065	216	D50302	185
D49582	211	D4984RB	20	D50066	213	D50310	185
D49583	211	D4984WB	20	D50067	214	D50311	185
D49584	211	D49850	218	D50068	216	D50330	185
D49585	211	D49851	218	D50069	213	D50331	185
D49586	211	D49852	218	D50070	214	D50332	185
D49587	211	D49853	218	D50071	216	D50333	185
D49588	211	D49854	218	D50072	213	D50334	185
D49589	211	D49855	218	D50073	214	D50335	185
D49590	211	D49856	218	D50074	216	D50340	213
D49595	211	D49857	218	D50075	213	D50341	213
D49596	211	D49858	218	D50076	214	D50342	213
D49597	211	D49860	218	D50077	216	D50343	213
D49598	211	D49861	218	D50089	225	D50345	213
D49640	190	D49862	218	D50090	225	D50346	213
D49641	190	D49863	218	D50091	225	D50349	213
D49642	190	D49864	218	D50092	225	D50350	213
D49643	190	D49865	218	D50093	225	D50351	215
D49644	190	D49866	218	D50094	225	D50352	215
D49645	190	D49867	218	D50095	225, 270	D50353	215
D49646	190	D49868	218	D50101	186	D50354	215
D49647	190	D4991BN	20	D50102	186	D50360	215
D49648	190	D4991RB	20	D50111	20, 186	D50361	215
D49649	190	D4991WB	20	D50120	185	D50362	216
D49650	190	D49924	224	D50121	185	D50363	216
D49651	190	D4996BN	20	D50122	185	D50364	216
D49652	190	D4996RB	20	D50123	185	D50365	216
D49653	190	D4996WB	20	D50124	185	D50366	216
D49654	190	D50000	396, 415	D50125	187	D50367	216
D49655	190	D50001	185	D50126	187	D50368	216
D49656	190	D50002	185	D50130	185	D50371	216
D49657	190	D50005	214	D50131	185	D50372	216
D49658	190	D50008	216	D50132	185	D50377	225
D49659	190	D50010	185	D50133	185	D50378	225
D49660	190	D50011	185	D50134	185	D50379	225
D49661	190	D50012	214	D50135	185	D50380	225
D49662	190	D50013	214	D50141	186	D50381	225
D49663	190	D50014	214	D50152	186	D50382	225
D49800	218	D50015	216	D50153	186	D50383	225
D49801	218	D50016	216	D50161	186	D50384	225
D49802	218	D5001BN	20, 186	D50162	186	D50385	225
D49803	218	D5001NP	186	D50177	225	D50386	225
D49804	218	D5001RB	20, 186	D50178	225	D50387	225
D49805	218	D5001WB	20, 186	D50179	225	D50388	225
D49806	218	D50022	213	D50180	225	D50389	225
D49807	218	D50023	213	D50181	225	D50390	225

<u>PART NO.</u>	<u>PG #</u>	<u>PART NO.</u>	<u>PG #</u>	<u>PART NO.</u>	<u>PG #</u>	<u>PART NO.</u>	<u>PG #</u>
D50391	225	D50723	187	D51052	215	D52204	218
D50392	225	D50724	187	D51053	212	D52205	218
D50393	225	D50725	187	D51054	214	D52207	218
D50394	225	D50726	187	D51055	215	D52216	218
D50401	186	D50727	187	D51060	213	D52217	218
D50402	186	D50800	186	D51061	214	D52302	218
D50411	186	D50802	186	D51062	216	D52303	218
D50440	189	D50830	186	D51063	213	D52304	218
D50448	189	D50832	186	D51064	214	D52305	218
D50449	189	D5087BN	19	D51065	216	D52306	218
D50450	189	D5087RB	19	D51066	213	D52307	218
D50451	189	D5087WB	19	D51067	214	D52316	218
D50452	189	D50887	19	D51068	216	D52317	218
D50453	189	D50888	20, 186	D51069	213	D52400	217
D50454	189	D5088BN	20, 186	D51070	214	D52450	217
D50460	190	D5088RB	20, 186	D51071	216	D52451	217
D50461	190	D5088WB	20, 186	D51072	213	D52452	217
D50462	190	D50904	225	D51073	214	D52453	217
D50463	190	D50905	225	D51074	216	D52460	217
D50464	190	D50906	225	D51075	213	D52461	217
D50465	190	D50907	225	D51076	214	D52462	217
D50469	190	D50908	225	D51077	216	D52463	217
D50470	190	D50909	225	D51278	212	D52500	217
D50471	190	D50910	225	D51279	214	D53001	197
D50472	190	D50911	225	D51280	215	D53002	197
D50473	190	D50942	19	D51340	213	D53003	197
D50474	190	D5094BN	19	D51341	213	D53004	197
D50477	190	D5094RB	19	D51342	213	D53005	197
D50479	190	D5094WB	19	D51343	213	D53006	197
D50480	190	D50980	219	D51344	213	D53008	197
D50481	190	D50982	219	D51345	213	D53009	197
D50482	190	D50983	219	D51346	213	D53011	197
D50486	190	D50984	219	D51349	213	D53012	197
D50500	187	D50985	219	D51350	213	D53014	197
D50501	187	D50986	219	D51351	215	D53015	197
D50502	187	D50987	219	D51352	215	D53017	197
D50510	187	D50988	219	D51353	215	D53018	197
D50511	187	D50989	219	D51354	215	D53020	191
D50520	189	D50990	219	D51355	215	D53021	191
D50521	189	D50998	186	D51356	215	D53022	191
D50522	189	D50PLP	187	D51357	215	D53023	191
D50523	189	D51004	214	D51360	215	D53024	191
D50524	189	D51005	214	D51361	215	D53025	191
D50525	189	D51007	216	D51362	216	D53026	192
D50526	189	D51008	216	D51363	216	D53027	192
D50600	227	D51012	214	D51364	216	D53028	192
D50601	227	D51013	214	D51365	216	D53029	192
D50682	225	D51014	214	D51366	216	D53031	192
D50683	225	D51015	216	D51367	216	D53032	192
D50700	187	D51016	216	D51368	216	D53033	192
D50701	187	D51022	213	D51371	216	D53034	192
D50702	187	D51023	213	D51372	216	D53035	192
D50703	187	D51027	213	D52003	218	D53037	192
D50704	187	D51028	213	D52004	217	D53040	194
D50705	187	D51037	212	D52005	217	D53041	194
D50706	187	D51038	214	D52012	217	D53043	194
D50707	187	D51039	215	D52014	217	D53044	194
D50708	187	D51040	212	D52016	217	D53045	194
D50709	187	D51041	214	D52017	217	D53046	194
D50710	187	D51042	215	D52023	217	D53047	194
D50711	187	D51044	212	D52103	218	D53048	194
D50712	187	D51045	214	D52104	217	D53049	194
D50713	187	D51046	215	D52105	217	D53051	194
D50714	187	D51047	212	D52112	217	D53052	194
D50715	187	D51048	214	D52120	217	D53053	194
D50720	187	D51049	215	D52123	217	D53054	194
D50721	187	D51050	212	D52202	218	D53055	194
D50722	187	D51051	214	D52203	218	D53057	194

<u>PART NO.</u>	<u>PG #</u>	<u>PART NO.</u>	<u>PG #</u>	<u>PART NO.</u>	<u>PG #</u>	<u>PART NO.</u>	<u>PG #</u>
D53058	197	D53134	194	D53234	196	D53404	197
D53059	197	D53135	194	D53235	196	D53405	197
D53060	197	D53136	194	D53236	196	D53406	197
D53061	197	D53137	194	D53237	196	D53407	197
D53062	197	D53138	192	D53238	196	D53408	197
D53063	197	D53139	192	D53239	196	D53409	197
D53064	197	D53140	192	D53240	196	D53410	197
D53065	197	D53141	192	D53241	196	D53411	197
D53066	197	D53142	192	D53249	191	D53412	197
D53067	197	D53143	192	D53252	194	D53413	197
D53068	197	D53144	214	D53253	194	D53414	194
D53069	197	D53145	214	D53260	193	D53415	194
D53070	197	D53146	214	D53261	193	D53416	194
D53071	197	D53147	214	D53262	195	D53417	194
D53072	191	D53148	214	D53263	195	D53418	194
D53073	191	D53149	214	D53264	195	D53419	194
D53074	191	D53150	195	D53265	195	D53420	194
D53075	191	D53151	195	D53266	195	D53421	194
D53076	191	D53152	195	D53268	195	D53422	194
D53077	191	D53153	195	D53269	195	D53423	194
D53078	192	D53154	195	D53272	195	D53424	194
D53079	192	D53155	195	D53273	195	D53425	194
D53080	192	D53156	195	D53274	195	D53426	194
D53081	192	D53157	195	D53275	195	D53427	194
D53082	192	D53158	195	D53276	195	D53428	191
D53083	192	D53159	195	D53278	195	D53429	191
D53084	192	D53160	195	D53279	195	D53430	191
D53085	192	D53161	195	D53280	197	D53431	191
D53086	194	D53162	195	D53281	197	D53432	191
D53087	194	D53163	195	D53282	194	D53433	191
D53088	194	D53180	196	D53283	194	D53434	191
D53089	194	D53181	196	D53284	191	D53435	191
D53090	194	D53182	196	D53285	191	D53436	191
D53091	194	D53183	196	D53286	195	D53437	191
D53092	194	D53184	196	D53287	195	D53438	191
D53093	194	D53185	196	D53288	193	D53439	191
D53094	194	D53186	196	D53289	193	D53440	191
D53095	194	D53187	196	D53290	192	D53441	191
D53096	194	D53188	196	D53291	192	D53442	212
D53097	194	D53189	196	D53292	196	D53443	212
D53098	194	D53190	192	D53293	196	D53444	212
D53099	194	D53191	192	D53294	195	D53445	212
D53100	193	D53192	192	D53295	195	D53446	212
D53101	193	D53193	192	D53296	192	D53447	212
D53102	193	D53194	192	D53297	192	D53448	212
D53103	193	D53195	192	D53298	192	D53449	212
D53104	193	D53196	192	D53299	192	D53450	212
D53105	193	D53197	192	D53300	195	D53451	212
D53106	193	D53198	192	D53301	195	D53452	212
D53107	193	D53199	192	D53302	195	D53453	212
D53108	193	D53200	192	D53303	195	D53454	212
D53109	193	D53201	192	D53304	195	D53455	212
D53110	193	D53202	192	D53305	195	D53457	214
D53111	193	D53203	192	D53306	193	D53458	214
D53120	197	D53204	193	D53307	193	D53459	214
D53121	197	D53205	193	D53308	195	D53460	214
D53122	197	D53206	193	D53309	195	D53461	214
D53123	197	D53207	193	D53310	196	D53462	214
D53124	192	D53208	193	D53311	196	D53463	214
D53125	192	D53209	193	D53312	193	D53464	214
D53126	192	D53216	193	D53313	193	D53465	214
D53127	192	D53217	193	D53314	196	D53466	214
D53128	194	D53218	193	D53315	196	D53467	214
D53129	194	D53219	193	D53325	192	D53468	214
D53130	194	D53230	196	D53400	197	D53469	214
D53131	194	D53231	196	D53401	197	D53470	215
D53132	194	D53232	196	D53402	197	D53471	215
D53133	194	D53233	196	D53403	197	D53472	215

<u>PART NO.</u>	<u>PG #</u>	<u>PART NO.</u>	<u>PG #</u>	<u>PART NO.</u>	<u>PG #</u>	<u>PART NO.</u>	<u>PG #</u>
D53473	215	D54332	224	D57902	237	D59915	237, 265
D53474	215	D54334	224	D57904	236	D59916	237, 265
D53475	215	D54336	224	D57905	236	D59917	237, 265
D53476	215	D54337	224	D57906	237	D59918	237, 265
D53477	215	D54400	224	D57907	237	D59919	237, 265
D53478	215	D54401	224	D57908	236	D59920	236
D53479	215	D56105	219	D57909	236	D59921	236
D53480	215	D56106	220	D57910	237	D59922	236
D53481	215	D56107	220	D57911	237	D59923	236
D53482	215	D56205	219	D57912	236	D59924	236
D53483	215	D56206	220	D57913	236	D59925	236
D54001	223	D56207	220	D57914	237	D59926	236
D54001L	223	D56208	220	D57915	237	D59927	236
D54002	223	D56209	220	D57916	237	D59940	265
D54002L	223	D56210	219	D57917	237	D59941	265
D54003	226	D56211	22, 220	D57918	237	D59942	265
D54004	226	D56212	22, 220	D57919	237	D59943	237, 265
D54005	226	D56213	220	D57980	219	D59944	237, 265
D54006	226	D56214	22, 220	D57982	219	D59945	237, 265
D54008	221	D56215	220	D57983	219	D59946	237, 265
D54010	22, 221	D56216	22, 220	D57984	219	D59947	237
D54011	223	D56217	220	D57985	219	D59948	237
D54012	223	D56304	219	D57986	219	D59949	237
D54013	223	D56305	219	D57987	219	D59950	237
D54013L	223	D56306	220	D57988	219	D60100	248
D54014	223	D56307	220	D57989	219	D60101	248, 259
D54014L	223	D56308	220	D57990	219	D60102	248
D54015	223	D56309	220	D59001	226	D60103	248
D54016	224	D56404	219	D59002	226	D60130	228
D54022	223	D56405	219	D59003	226	D60131	228
D54100	224	D56406	220	D59100	221	D60140	228
D54101	224	D56407	220	D59101	273	D60141	228
D54102	224	D56408	220	D59102	273	D60201	248
D54104	224	D56409	220	D59103	273	D60202	248
D54105	224	D56501	219, 256	D59104	273	D60203	248
D54107	224	D56503	220, 256	D59106	273	D60204	248
D54108	221	D56505	221, 256	D59112	273	D60205	248
D54111	224	D57105	219	D59113	273	D60206	248
D54112	224	D57106	220	D59114	273	D60207	248
D54113	224	D57107	220	D59124	273	D60208	248
D54114	224	D57205	219	D59126	273	D60209	248
D54126	224	D57206	220	D59128	273	D60210	248
D54130	224	D57207	220	D59130	273	D60211	248
D54131	224	D57208	220	D59132	273	D60212	248
D54132	224	D57209	220	D59156	270	D60400	248
D54134	224	D57210	219	D59158	270	D60402	248
D54136	224	D57211	220	D59160	270	D60403	248
D54137	224	D57212	220	D59162	270	D60410	248
D54301	223	D57213	220	D59202	274	D60412	248
D54302	223	D57214	220	D59203	274	D60413	248
D54304	224	D57215	220	D59204	274	D60498	248
D54305	224	D57216	220	D59302	274	D60499	248
D54306	224	D57217	220	D59303	274	D60780	221
D54307	224	D57304	219	D59304	274	D60781	221
D54311	223	D57305	219	D59900	191	D60782	221
D54312	223	D57306	220	D59901	237, 265	D60790	221
D54313	223	D57307	220	D59902	237, 265	D60791	221
D54314	223	D57308	220	D59904	236, 265	D60792	221
D54315	223	D57309	220	D59905	236, 265	D60793	221
D54316	224	D57404	219	D59906	237, 265	D60795	221
D54319	223	D57405	219	D59907	237, 265	D6084BN	22
D54321	224	D57406	220	D59908	236, 265	D6084RB	22
D54322	224	D57407	220	D59909	236, 265	D6084WB	22
D54323	224	D57408	220	D59910	237, 265	D60900	249
D54324	224	D57409	220	D59911	237, 265	D60901	249
D54326	224	D57501	219	D59912	236, 265	D60902	249
D54330	224	D57505	221	D59913	236, 265	D6091BN	22
D54331	224	D57901	237	D59914	237, 265	D6091RB	22

PART NO.	PG #
D6091WB	22
D60940	221
D60942	19
D60945	219
D6094BN	19
D6094PB	19
D6094RB	19
D6094WB	19
D60954	19, 220, 257
D60955	219, 257
D60956	219, 257
D60958	221, 257
D60959	221, 257
D60960	19, 220, 257
D60961	220, 257
D60962	19, 220, 257
D60963	220, 257
D60966	221, 257
D60967	221, 257
D60968	221
D60969	221
D6096BN	19
D6096RB	19
D6096WB	19
D60970	219, 257
D60975	219, 257
D60978	186
D60979	222, 256
D60980	19, 219, 257
D60981	19, 219, 257
D60982	19, 219, 257
D60986	220, 257
D60987	220, 257
D60989	220, 257
D6098BN	19
D6098RB	19
D6098WB	19
D60990	22, 220, 257
D60991	22, 220, 257
D60992	220, 257
D60993	220, 257
D60995	220, 257
D60996	22, 220, 257
D60997	220, 257
D60998	220, 257
D60999	220, 257
D61101	249
D61102	249
D61103	249
D61201	249
D61202	249
D61203	249
D61301	249
D61302	249
D61303	249
D61800	249
D61801	249
D61802	249
D61850	249
D62130	256
D62131	256
D62132	256
D62135	256
D62136	256
D62137	256
D62140	256
D62141	256
D62142	256

PART NO.	PG #
D62230	265
D62231	265
D62232	265
D62235	265
D62236	265
D62237	265
D62240	265
D62241	265
D62242	265
D62300	256, 265
D62330	261
D62333	261
D62334	261
D62335	261
D62349	256, 265
D62350	256, 265
D62400	256, 265
D62433	261
D62434	261
D62443	261
D62444	261
D62601	261
D62602	261
D62950	258
D62951	258
D62952	258
D62960	258
D62961	258
D62962	258
D63300	256, 264
D63330	262
D63333	262
D63334	262
D63335	262
D63349	256, 264
D63350	256, 264
D63400	256, 264
D63433	262
D63434	262
D64000	21, 248
D64001	21, 248
D64002	247
D6400BN	21, 248
D6400RB	21, 248
D6400WB	21, 248
D64010	248
D64011	248
D64012	247
D64022	247
D64150	247
D64202	247
D64302	247
D64401	21, 248
D64502	247
D64800	247
D64801	247
D64802	247
D64803	247
D64804	247
D64805	247
D64806	247
D64807	247
D64808	247
D64809	247
D64810	247
D64811	247
D65002	255
D65003	255

PART NO.	PG #
D65102	255
D65103	255
D65104	255
D65202	255
D65203	255
D65500	250
D65501	250
D65502	250
D65503	250
D65504	250
D65505	250
D65509	250
D65510	250
D65511	250
D65512	250
D65520	252
D65521	252
D65522	252
D65523	252
D65524	252
D65525	252
D65560	251
D65561	251
D65562	251
D65563	251
D65564	251
D65565	251
D65569	251
D65570	251
D65571	251
D65572	251
D65580	253
D65581	253
D65582	253
D65583	253
D65584	253
D65585	253
D65600	254
D65601	254
D65602	254
D65603	254
D65604	254
D65605	254
D65620	251
D65621	251
D65622	251
D65623	251
D65624	251
D65625	251
D65640	253
D65641	253
D65642	253
D65643	253
D65644	253
D65645	253
D65655	251
D65656	251
D65657	253
D65658	253
D65659	254
D65660	254
D65661	250
D65662	250
D65663	252
D65664	252
D65665	251
D65667	253
D65668	253

PART NO.	PG #
D66002	255
D66003	255
D66004	255
D66102	255
D66103	255
D66104	255
D66200	256
D66202	255
D66203	255
D66204	255
D66400	256
D66500	250
D66501	250
D66502	250
D66503	250
D66504	250
D66505	250
D66509	250
D66510	250
D66511	250
D66512	250
D66520	252
D66521	252
D66522	252
D66523	252
D66524	252
D66525	252
D66540	254
D66541	254
D66542	254
D66543	254
D66544	254
D66545	254
D66560	251
D66561	251
D66562	251
D66563	251
D66564	251
D66565	251
D66569	251
D66570	251
D66571	251
D66572	251
D66580	253
D66581	253
D66582	253
D66583	253
D66584	253
D66585	253
D66600	254
D66601	254
D66602	254
D66603	254
D66604	254
D66605	254
D66620	251
D66621	251
D66622	251
D66623	251
D66624	251
D66625	251
D66640	253
D66641	253
D66642	253
D66643	253
D66644	253
D66645	253
D66660	254

PART NO.	PG #	PART NO.	PG #	PART NO.	PG #	PART NO.	PG #
D66661	254	D67040	253	D76202	269	D80217	252
D66662	254	D67042	253	D76203	269	D80218	253
D66663	254	D67043	253	D76204	269	D80219	253
D66664	254	D67044	253	D76205L	269	D80220	253
D66665	254	D67045	253	D76207L	269	D80221	253
D66675	251	D67046	253	D76209L	269	D80222	253
D66676	251	D67047	253	D76252	269	D80223	253
D66677	253	D67048	254	D76256	269	E01049	79
D66678	253	D67049	254	D76259	269	E01050	79
D66679	254	D67050	254	D76302	269	E0105BN	22
D66680	254	D67051	254	D76303	269	E0105RB	22
D66681	250	D67052	254	D76304	269	E0105WB	22
D66682	250	D67053	254	D76402	269	E01074	79
D66683	252	D67054	254	D76403	269	E01075	79
D66684	252	D67055	254	D76404	269	E01100	79
D66685	254	D67200	256	D76412	269	E01125	79
D66686	254	D67201	256	D76413	269	E01150	79
D66687	251	D67300	256	D76414	269	E01375	79
D66688	251	D67400	256	D76504	270	E02050	79
D66689	253	D68507	252	D76519	270	E0205BN	22
D66690	253	D68508	252	D76601	259	E0205RB	22
D66691	254	D68510	252	D76702	270	E0205WB	22
D66692	254	D68511	252	D76703	270	E02075	79
D66700	251	D68512	252	D76704	270	E02100	79
D66701	251	D68513	252	D76705	270	E02125	79
D66702	251	D68710	252	D76707	270	E02150	79
D66703	251	D68711	252	D77002	258	E02152	79
D66704	251	D68712	252	D77003	258	E02200	79
D66705	251	D68713	252	D77004	258	E02375	79
D66706	251	D70001	259	D79703	270	E03125	79, 338
D66707	251	D70011	259	D79704	270	E03150	79, 338
D66732	254	D70020	259	D79705	270	E03200	79, 338
D66733	254	D70021	259	D79706	270	E03225	80
D66734	254	D70022	259	D79803	270	E03250	80
D66735	254	D70098	259	D79804	270	E04125	79, 338
D66736	254	D70100	333	D79805	270	E0412BN	22
D66737	254	D70100	68	D79806	270	E0412RB	22
D66738	254	D70101	68, 333	D80090	255	E0412WB	22
D66739	254	D70102	68, 333	D80091	255	E04150	79, 338
D67001	250	D70103	68, 333	D80096	255	E0415BN	22
D67002	250	D70104	68	D80097	255	E0415RB	22
D67003	250	D70105	6, 68	D80098	255	E0415WB	22
D67004	250	D7010BN	6	D80099	255	E04200	79, 338
D67005	250	D7010PB	6	D80100	252	E05125	79
D67006	250	D7010RB	6	D80101	252	E05150	79
D67007	250	D7010WB	6	D80102	252	E06050	79
D67008	250	D70205	6	D80103	252	E0605BN	22
D67016	251	D7020BN	6	D80106	253	E0605PB	22
D67017	251	D7020RB	6	D80107	253	E0605RB	22
D67018	251	D7020WB	6	D80108	253	E0605WB	22
D67019	251	D70210	6	D80109	253	E06075	79
D67020	251	D7021BN	6	D80112	252	E06100	79
D67021	251	D7021RB	6	D80113	252	E06125	79
D67022	251	D7021WB	6	D80118	253	E06150	79
D67023	251	D70500	259	D80119	253	E06375	79
D67027	251	D71003	259	D80200	252	E07025	79
D67028	251	D71004	259	D80201	252	E07050	79
D67029	251	D71103	259	D80202	252	E0705BN	22
D67030	251	D76002	258	D80203	252	E0705PB	22
D67031	253	D76003	258	D80206	253	E0705RB	22
D67032	253	D76004	258	D80207	253	E0705WB	22
D67033	253	D76005	263	D80209	253	E07375	79
D67034	253	D76012	258	D80211	253	E08125	79
D67035	253	D76013	258	D80212	252	E0812BN	22
D67036	253	D76014	258	D80213	252	E0812PB	22
D67037	253	D76092	258	D80214	252	E0812RB	22
D67038	253	D76093	258	D80215	252	E0812WB	22
D67039	253	D76094	258	D80216	252	E08138	79

PART NO.	PG #
E08150	79
E0815BN	22
E0815PB	22
E0815RB	22
E0815WB	22
E09050	96
E09075	96
E09100	96
E09125	96
E09150	96
E09200	96
E09250	96
E09300	96
E09400	96
E10150	98
E10200	98
E10300	98
E10400	98
E15050	80
E15052	80
E15075	80
E15375	80
E16050	80
E16075	80
E16150	80
E16151	80
E16200	80
E16375	80
E25000	308, 405, 414
E25001	308, 405, 414
E25002	308, 405, 414
E25004	308, 405, 414
E25005	308, 405, 416
E25006	308, 405, 416
E25007	308, 405
E25010	308, 405
E25015	309
E25016	309
E25017	309
E25018	309
E25021	308, 406, 414, 416
E25040	308, 405
E25041	308, 405
E25042	308, 405
E25045	308, 405, 414
E25046	308, 405, 414
E25115	309
E25116	309
E25117	309
E25118	309
E25125	309
E25126	309
E25127	309
E25128	309
E25129	309
E25200	308
E25201	308
E25202	308
E25203	308
E25204	308
E25250	307, 406, 413, 414, 416
E25251	308, 406
E25300	406
E25301	406
E25302	406
E25320	406
E26001	308

PART NO.	PG #
E26002	308
E26003	308
E26004	308
E80050	23
E80075	23
E81050	23
E81375	23
E82125	23
E82150	23
E85000	399, 413
F01050	80
F01075	80
F01100	80
F01125	80
F01150	80
F01375	80
F02050	80
F02075	80
F02100	80
F02125	80
F02150	80
F02200	80
F02375	80
F03050	80
F03075	80
F03100	80
F03125	80
F03150	80
F03200	80
F03250	80
F03300	80
F03375	80
F04050	80
F04075	80
F04100	80
F04125	80
F04150	80
F04200	80
F04250	80
F04300	80
F04350	80
F04375	80
F04400	80
F04500	80
F04600	80
F04800	80
F04999	80
F05001	3
F06050	80
F06075	80
F06099	80
F06100	80
F06124	80
F06125	80
F06150	80
F06200	80
F06201	80
F06250	80
F06251	80
F06300	80
F06301	80
F06351	80
F06375	80
F06400	80
F06401	80
F06500	80
F06600	80
F06800	80

PART NO.	PG #
F07050	80
F07075	80
F07099	80
F07100	80
F07124	80
F07125	80
F07150	80
F07200	80
F07201	80
F07300	80
F07375	80
F08050	23
F08124	23
F08150	23
F08375	23
F10001	183
F10002	183
F10003	183
F10004	183
F10005	259
F11001	183
F11002	183
F11003	183
F11004	183
F12009	118
F12012	118
F12018	118
F12024	118
F14012	119
F160063	119
F160093	119
F160094	119
F16012	119
F160123	119
F160126	119
F16016	119
F160183	119
F160184	119
F160186	119
F160243	119
F160246	119
F160363	119
F160393	119
F163186	119
F163246	119
F165181	119
F165186	119
F180032	119
F18009	118
F18012	118
F18018	118
F18024	118
F18309	118
F18312	118
F18318	118
F18324	118
F20001	307, 407
F20001	421
F20002	307, 407
F20003	306, 407, 414
F20003	421
F20004	306, 407, 414
F20005	306, 407
F20006	308, 407
F20007	308, 407
F20008	308, 407, 414
F20009	308, 407
F20010	308, 407

PART NO.	PG #
F20011	308, 407
F20012	308, 407, 414
F20017	306, 407
F20017	421
F20018	307, 407
F20019	307, 407, 414
F20019	421
F20020	309, 407
F20021	309, 407
F20022	309, 407
F20023	309, 407
F20024	309, 407
F20025	309, 407
F20026	309, 407
F20050	307, 406
F20051	307, 407, 414
F20052	307, 406
F20052	421
F20053	307, 406, 414
F20053	421
F20054	307, 406
F20054	421
F20055	307, 407
F20055	421
F33009	126
F33010	126
F33011	126
F33012	126
F33013	126
F33014	126
F33030	126
F33031	126
F33032	126
F33033	126
F33034	126
F33035	126
F33036	126
F33037	126
F33038	126
F33039	126
F33040	126
F33041	126
F33060	126
F33061	126
F33062	126
F33063	126
F33064	126
F33065	126
F33066	126
F33067	126
F33068	126
F33069	126
F33080	127
F33081	127
F33082	127
F33083	127
F33094	127
F33095	127
F33096	127
F33097	127
F33098	127
F33101	127
F33102	127
F33103	127
F33104	127
F33105	127
F33106	127
F33107	127

PART NO.	PG #	PART NO.	PG #	PART NO.	PG #	PART NO.	PG #
F33108	127	F40031	137	F40103	138	G08024	169
F33109	127	F40032	137	F40104	138	G09004	169
F33110	127	F40033	137	F40105	138	G09006	169
F33111	127	F40034	137	F40106	138	G09008	169
F33112	127	F40035	137	F40107	138	G09012	169
F33113	127	F40036	137	F40108	138	G09016	169
F33114	127	F40037	137	F40109	138	G09020	169
F33115	127	F40038	137	F40110	138	G09024	169
F33116	127	F40039	137	F40111	138	G10006	170
F33120	127	F40040	137	F40112	138	G10008	170
F33121	127	F40041	137	F40113	138	G10010	170
F33122	127	F40042	138	F40114	138	G10012	170
F33123	127	F40043	138	F40115	138	G10016	170
F33124	127	F40044	138	F40116	138	G10020	170
F33125	127	F40045	138	F40117	138	G10024	170
F33126	127	F40047	138	F40118	138	G10032	170
F33127	127	F40048	138	F40119	137	G10036	170
F33128	127	F40049	138	F40120	137	G10040	170
F33129	127	F40050	138	F40121	138	G10052	170
F33130	127	F40051	138	F40122	138	G10072	170
F33131	127	F40052	138	F40125	137	G10080	170
F33132	127	F40053	138	F40126	137	G10104	170
F33140	126	F40054	138	F40127	137	G11006	170
F33141	126	F40055	138	F40128	138	G11008	170
F33142	126	F40056	138	F40131	137	G11010	170
F33143	126	F40057	138	F40132	137	G11012	170
F33144	126	F40058	138	F40133	137	G11016	170
F33300	126	F40059	138	F40135	138	G11020	170
F33301	126	F40060	138	F401516	139	G11024	170
F33302	126	F40061	138	F41002	139	G11028	170
F33303	126	F40063	138	F41003	139	G11032	170
F39001	85	F40064	138	F41004	139	G11036	170
F39002	85	F40065	138	F41005	139	G11040	170
F39004	85	F40066	138	F41006	139	G11044	170
F39005	85	F40067	138	F41007	139	G11048	170
F39010	86	F40068	138	F41008	139	G11052	170
F39700	69	F40069	138	F41009	139	G11056	170
F39800	69	F40070	138	F41011	139	G11064	170
F40001	137	F40071	138	F41012	139	G11072	170
F40002	137	F40072	138	F41013	139	G11080	170
F40003	137	F40073	138	F411516	139	G11088	170
F40004	137	F40074	138	F46108	139	G11096	170
F40005	137	F40075	138	F481012	139	G11104	170
F40006	137	F40076	138	F48108	139	G12012	67
F40007	137	F40077	138	F65400	222, 257	G12016	67
F40008	137	F40078	138	F65600	222, 257	G12018	67
F40009	137	F40079	138	G01850	45	G12024	67
F40010	137	F40080	138	G02010	396, 415, 416	G12030	67
F40011	137	F40081	138	G02011	396, 415, 416	G12032	67
F40012	137	F40082	138	G02042	396, 415, 416	G12036	67
F40013	137	F40083	138	G02050	396, 415	G12042	67
F40014	137	F40084	138	G04000	400	G12048	67
F40015	137	F40085	138	G04001	400, 416	G12112	67
F40016	137	F40086	138	G04002	400, 415	G12116	67
F40017	137	F40087	138	G04003LF	169	G12118	67
F40018	137	F40088	138	G04004	169	G12124	67
F40019	137	F40089	138	G04005	400	G12130	67
F40020	137	F40091	138	G04006	400	G12132	67
F40021	137	F40092	138	G04025	400	G12136	67
F40022	137	F40093	138	G04026	400, 415	G12142	67
F40023	137	F40094	138	G04030	400, 415	G12148	67
F40024	137	F40095	137	G04031	400, 415	G12212	67
F40025	137	F40096	137	G08004	169	G12216	67
F40026	137	F40097	137	G08006	169	G12218	67
F40027	137	F40098	137	G08008	169	G12224	67
F40028	137	F40100	137	G08012	169	G12230	67
F40029	137	F40101	138	G08016	169	G12232	67
F40030	137	F40102	138	G08020	169	G12236	67

PART NO.	PG #	PART NO.	PG #	PART NO.	PG #	PART NO.	PG #
G12242	67	G14032	170	G155-0100	351	G165-0532	352
G12248	67	G14036	170	G155-0150	351	G165-0533	352
G12312	67	G14040	170	G155-0215	351	G165-0534	352
G12316	67	G14044	170	G155-0295	351	G165-0650	351
G12318	67	G14048	170	G155-0390	351	G165-0662	352
G12324	67	G14052	170	G155-0520	351	G165-0663	352
G12330	67	G14056	170	G155-0650	351	G165-0664	352
G12332	67	G14064	170	G155-0860	351	G165-0665	352
G12336	67	G14072	170	G155-0975	351	G165-0666	352
G12342	67	G14080	170	G155-1100	351	G165-0860	351
G12348	67	G14088	170	G16006	170	G165-0870	352
G12999	67	G14096	170	G16008	170	G165-0871	352
G13001	55	G14104	170	G16010	170	G165-0872	352
G13002	55	G144-0007	351	G16012	170	G165-1100	351
G13003	55	G144-0032	351	G16016	170	G165-1109	352
G13004	55	G144-0033	351	G16020	170	G17025	163
G13005	55	G144-0058	351	G16024	170	G17037	163
G13012	67	G144-0059	351	G16028	170	G17050	163
G13016	67	G144-0060	351	G16032	170	G17075	163
G13018	67	G144-0107	351	G16036	170	G17100	163
G13024	67	G144-0108	351	G16040	170	G17125	163
G13030	67	G144-0109	351	G16044	170	G17150	163
G13032	67	G144-0110	351	G16048	170	G17200	163
G13036	67	G144-0159	351	G16052	170	G18025	163
G13042	67	G144-0160	351	G16056	170	G18037	163
G13048	67	G144-0161	351	G16064	170	G18050	163
G13112	67	G144-0162	351	G16072	170	G18075	163
G13116	67	G144-0222	351	G16080	170	G18100	163
G13118	67	G144-0223	351	G16088	170	G18125	163
G13124	67	G144-0224	351	G16096	170	G18150	163
G13130	67	G144-0225	351	G16104	170	G18200	163
G13132	67	G144-0226	351	G165-0001	351	G19025	163
G13136	67	G144-0303	351	G165-0002	351	G19037	163
G13142	67	G144-0304	351	G165-0007	352	G19050	163
G13148	67	G144-0305	351	G165-0025	351	G19075	163
G13212	67	G144-0306	351	G165-0032	352	G19100	163
G13216	67	G144-0307	351	G165-0033	352	G19125	163
G13218	67	G144-0308	351	G165-0050	351	G19150	163
G13224	67	G144-0398	351	G165-0058	352	G19200	163
G13230	67	G144-0399	351	G165-0059	352	G195-0002	353
G13232	67	G144-0400	351	G165-0060	352	G195-0025	353
G13236	67	G144-0401	351	G165-0100	351	G195-0050	353
G13242	67	G144-0402	351	G165-0107	352	G195-0100	353
G13248	67	G144-0531	351	G165-0108	352	G195-0150	353
G13312	67	G144-0532	351	G165-0109	352	G195-0215	353
G13316	67	G144-0533	351	G165-0150	351	G195-0295	353
G13318	67	G144-0534	351	G165-0159	352	G195-0390	353
G13324	67	G144-0535	351	G165-0160	352	G20002	154
G13330	67	G144-0662	351	G165-0161	352	G20003	154
G13332	67	G144-0663	351	G165-0162	352	G20004	154
G13336	67	G144-0664	351	G165-0215	351	G20005	154
G13342	67	G144-0665	351	G165-0222	352	G20006	155
G13348	67	G144-0666	351	G165-0223	352	G20008	154
G13500	48	G144-0790	351	G165-0224	352	G20010	154
G13516	48	G144-0870	351	G165-0295	351	G20011	154
G13534	48	G144-0871	351	G165-0303	352	G20015	154
G13601	48	G144-0872	351	G165-0304	352	G20016	154
G13616	48	G144-0873	351	G165-0305	352	G20017	154
G13634	48	G144-1109	351	G165-0306	352	G20020	154
G13638	48	G15002	169	G165-0307	352	G20021	154
G14006	170	G15003	169	G165-0390	351	G20030	154
G14008	170	G15004	169	G165-0398	352	G20031	154
G14010	170	G15006	169	G165-0399	352	G20032	154
G14012	170	G15008	169	G165-0400	352	G20035	155
G14016	170	G155-0001	351	G165-0401	352	G20036	155
G14020	170	G155-0002	351	G165-0402	352	G20037	155
G14024	170	G155-0025	351	G165-0520	351	G20038	155
G14028	170	G155-0050	351	G165-0531	352	G20040	155

<u>PART NO.</u>	<u>PG #</u>	<u>PART NO.</u>	<u>PG #</u>	<u>PART NO.</u>	<u>PG #</u>	<u>PART NO.</u>	<u>PG #</u>
G20041	155	G235-0860	352	G27086	156	G396-0100	355
G20042	155	G235-1100	352	G27088	156	G396-0150	355
G20043	155	G24004	156	G27106	156	G396-0215	355
G20045	155	G24006	156	G27108	156	G396-0295	355
G20047	155	G25022	156	G28044	156	G396-0390	355
G20050	155	G25032	156	G28066	156	G396-0520	355
G20051	155	G25034	156	G28088	156	G396-0650	355
G20052	155	G25042	156	G290-0001	353	G396-0860	355
G20053	155	G25044	156	G290-0002	353	G460-0001	354
G20054	155	G25046	156	G290-0025	353	G460-0002	354
G20055	155	G25048	156	G290-0050	353	G460-0025	354
G20056	155	G25052	156	G290-0100	353	G460-0050	354
G20057	155	G25054	156	G290-0150	353	G460-0057	354
G20057R	155	G25056	156	G290-0215	353	G460-0058	354
G20060	155	G25062	156	G290-0295	353	G460-0059	354
G20086LF	83	G25064	156	G290-0390	353	G460-0100	354
G20102	154	G25066	156	G290-0520	353	G460-0106	354
G20103	154	G25068	156	G290-0650	353	G460-0107	354
G20108	154	G25084	156	G290-0860	353	G460-0108	354
G20110	154	G25086	156	G29003	156	G460-0109	354
G20111	154	G25088	156	G29004	156	G460-0116	354
G20115	154	G25101	156	G29005	156	G460-0117	354
G20116	154	G25106	156	G29006	156	G460-0118	354
G20120	154	G25108	156	G29008	156	G460-0150	354
G20121	154	G25121	156	G29010	156	G460-0157	354
G20130	154	G25128	156	G295-0002	353	G460-0159	354
G20131	155	G25161	156	G295-0050	353	G460-0160	354
G20132	155	G25169	156	G295-0100	353	G460-0162	354
G20136	155	G254-0001	353	G295-0150	353	G460-0169	354
G20137	155	G254-0002	353	G295-0215	353	G460-0170	354
G20138	155	G254-0025	353	G295-0295	353	G460-0171	354
G20141	155	G254-0050	353	G295-0390	353	G460-0180	354
G20142	155	G254-0100	353	G295-0650	353	G460-0181	354
G20143	155	G254-0150	353	G30000	399	G460-0182	354
G20150	155	G254-0215	353	G30001	399	G460-0215	354
G20155	155	G254-0295	353	G30003	399, 413	G460-0221	354
G235-0001	352	G254-0390	353	G30004	399	G460-0222	354
G235-0002	352	G254-0520	353	G30005	399	G460-0223	354
G235-0025	352	G254-0650	353	G30011	399	G460-0224	354
G235-0050	352	G254-0860	353	G30012	399	G460-0234	354
G235-0058	352	G25612	156	G30013	399	G460-0235	354
G235-0059	352	G25812	156	G30014	399	G460-0236	354
G235-0100	352	G26022	156	G30015	399	G460-0237	354
G235-0107	352	G26032	156	G30016	399, 413	G460-0245	354
G235-0108	352	G26034	156	G30017	399	G460-0246	354
G235-0150	352	G26042	156	G30021	399, 413, 416	G460-0247	354
G235-0159	352	G26044	156	G30030	399, 413	G460-0258	354
G235-0160	352	G26046	156	G335-0050	351	G460-0295	354
G235-0215	352	G26052	156	G335-0100	351	G460-0303	354
G235-0222	352	G26054	156	G335-0150	351	G460-0304	354
G235-0223	352	G26056	156	G335-0215	351	G460-0305	354
G235-0224	352	G26062	156	G355-0025	353	G460-0306	354
G235-0295	352	G26064	156	G355-0050	353	G460-0315	354
G235-0303	352	G26066	156	G355-0100	353	G460-0316	354
G235-0304	352	G26068	156	G355-0150	353	G460-0317	354
G235-0305	352	G26084	156	G355-0215	353	G460-0318	354
G235-0306	352	G26086	156	G355-0295	353	G460-0319	354
G235-0390	352	G26088	156	G355-0390	353	G460-0328	354
G235-0398	352	G26121	156	G375-0002	353	G460-0330	354
G235-0399	352	G26161	156	G375-0050	353	G460-0340	354
G235-0400	352	G27042	156	G375-0150	353	G460-0350	354
G235-0401	352	G27044	156	G375-0215	353	G460-0390	354
G235-0520	352	G27054	156	G375-0295	353	G460-0398	354
G235-0532	352	G27062	156	G375-0390	353	G460-0399	354
G235-0533	352	G27064	156	G396-0001	355	G460-0400	354
G235-0650	352	G27066	156	G396-0002	355	G460-0401	354
G235-0662	352	G27068	156	G396-0025	355	G460-0402	354
G235-0663	352	G27084	156	G396-0050	355	G460-0414	354

PART NO.	PG #
G460-0415	354
G460-0416	354
G460-0429	354
G460-0430	354
G460-0431	354
G460-0444	354
G460-0447	354
G460-0470	354
G460-0520	354
G460-0531	354
G460-0532	354
G460-0534	354
G460-0536	354
G460-0650	354
G460-0662	354
G460-0663	354
G460-0665	354
G460-0666	354
G460-0860	354
G460-0870	354
G460-0872	354
G486-0100	353
G486-0150	353
G50200	413
G50200	303, 398, 424
G50202	303, 397
G50204	303, 398, 413, 424
G50204	420
G50205	303, 398
G50206	303, 398
G50208	304, 398
G50210	303
G50211	302
G50212	303, 397, 413, 416
G50214	303
G50215	303, 398, 413
G50218	304
G50220	303, 398
G50223	303, 398
G50223	420
G50225	303, 398
G50225	420
G50228	303, 398
G50228	420
G50229	303, 398
G50229	420
G50230	303, 397, 413, 416
G50231	303, 397, 413, 416
G50250	304, 397, 416
G50251	304, 397, 413
G50300	303, 398
G50300	420
G50302	304, 397
G50302	420
G51001	171
G51002	171
G51003	171
G51004	171
G51005	171
G51006	171
G51008	171
G51010	171
G51012	171
G51013	171
G51015	171
G51025	171
G51035	171
G51050	171

PART NO.	PG #
G51075	171
G51102	172
G51103	172
G51104	172
G51105	172
G51106	172
G51108	172
G51110	172
G51112	172
G51125	172
G51135	172
G52001	171
G52002	171
G52003	171
G52004	171
G52005	171
G52006	171
G52008	171
G52010	171
G52012	171
G52013	171
G52015	171
G52025	171
G52035	171
G52075	171
G52102	172
G52103	172
G52104	172
G52105	172
G52106	172
G52108	172
G52110	172
G52115	172
G52125	172
G53001	171
G53002	171
G53003	171
G53004	171
G53005	171
G53006	171
G53008	171
G53010	171
G53012	171
G53013	171
G53015	171
G53025	171
G53035	171
G53050	171
G53075	171
G53101	171
G53102	171
G53103	171
G53104	171
G53105	171
G53106	171
G53108	171
G53110	171
G53113	171
G53115	171
G53125	171
G53203	172
G53204	172
G53206	172
G53215	172
G53225	172
G54001	171
G54002	171
G54003	171

PART NO.	PG #
G54004	171
G54005	171
G54006	171
G54008	171
G54010	171
G54012	171
G54013	171
G54015	171
G54025	171
G54035	171
G54075	171
G54102	171
G54103	171
G54104	171
G54105	171
G54106	171
G54108	171
G54110	171
G54112	171
G54115	171
G54125	171
G54202	172
G54203	172
G54204	172
G54205	172
G54206	172
G54208	172
G54210	172
G54212	172
G54215	172
G54225	172
G55001	172
G55002	172
G55003	172
G55004	172
G55005	172
G55014	172
G55016	172
G55018	172
G55116	172
G55118	172
G55150	172
G55200	172
G55250	172
G55300	172
G55350	172
G55400	172
G55450	172
G55500	172
G55550	172
G55600	172
G60000	115
G60001	115
G60005	114
G60015	115
G60030	115
G60055	114
G60060	115
G60100	115
G60160	115
G60200	115
G60300	115
G61005	115
G61015	115
G61030	115
G61060	115
G61100	115
G61160	115

PART NO.	PG #
G61200	115
G61300	115
G62030	115
G62060	115
G62100	115
G62200	115
G62300	115
G63001	116
G64000	116
G64001	116
G64002	116
G64004	116
G64005	115
G64015	115
G64020	116
G64030	116
G64060	116
G64100	116
G64101	115
G64155	115
G64160	116
G64200	116
G64300	116
G64301	116
G64333	116
G65155	115
G657-0001	355
G657-0002	355
G657-0025	355
G657-0050	355
G657-0100	355
G657-0150	355
G657-0215	355
G657-0295	355
G657-0390	355
G657-0520	355
G657-0650	355
G657-0860	355
G66000	115
G66002	115
G66015	115
G66030	115
G66060	115
G66100	115
G67000	115
G67002	115
G67015	115
G67030	115
G67060	115
G67100	115
G70000	87
G70001	87
G70002	87
G70003	87
G70004	87
G70005	87
G70006	87
G70007	87
G70008	87
G70009	87
G70010	87
G70011	87
G70012	87
G70013	87
G70014	87
G70015	87
G70016	87
G70017	87

PART NO.	PG #	PART NO.	PG #	PART NO.	PG #	PART NO.	PG #
G70018	87	G70130	88	G71006	89	G71077	89
G70019	87	G70131	88	G71007	89	G71078	89
G70020	87	G70132	88	G71008	89	G71079	89
G70021	87	G70133	88	G71009	89	G71100	90
G70022	87	G70134	88	G71010	89	G71102	90
G70023	87	G70135	88	G71011	89	G71103	90
G70024	87	G70136	88	G71012	89	G71104	90
G70025	87	G70137	88	G71013	89	G71105	90
G70026	87	G70138	88	G71014	89	G71106	90
G70027	87	G70139	88	G71015	89	G71107	90
G70028	87	G70140	88	G71016	89	G71108	90
G70029	87	G70141	88	G71017	89	G71109	90
G70030	87	G70142	88	G71018	89	G71110	90
G70031	87	G70143	88	G71019	89	G71111	90
G70032	87	G70144	88	G71020	89	G71112	90
G70033	87	G70145	88	G71021	89	G71113	90
G70034	87	G70146	88	G71022	89	G71114	90
G70035	87	G70147	88	G71023	89	G71115	90
G70036	87	G70148	88	G71024	89	G71116	90
G70037	87	G70149	88	G71025	89	G71117	90
G70038	87	G70150	88	G71026	89	G71118	90
G70039	87	G70151	88	G71027	89	G71119	90
G70040	87	G70152	88	G71028	89	G71120	90
G70041	87	G70153	88	G71029	89	G71121	90
G70042	87	G70154	88	G71031	89	G71122	90
G70043	87	G70155	88	G71032	89	G71123	90
G70044	87	G70200	88	G71033	89	G71124	90
G70045	87	G70201	88	G71034	89	G71125	90
G70046	87	G70203	88	G71035	89	G71126	90
G70047	87	G70205	88	G71036	89	G71127	90
G70048	87	G70206	88	G71037	89	G71128	90
G70049	87	G70207	88	G71038	89	G71129	90
G70050	87	G70208	88	G71039	89	G71130	90
G70051	87	G70209	88	G71040	89	G71131	90
G70052	87	G70210	88	G71041	89	G71132	90
G70053	87	G70211	88	G71042	89	G71133	90
G70054	87	G70212	88	G71043	89	G71134	90
G70055	87	G70213	88	G71044	89	G71135	90
G70100	87	G70214	88	G71045	89	G71136	90
G70101	87	G70215	88	G71046	89	G71137	90
G70102	87	G70216	88	G71047	89	G71138	90
G70103	87	G70217	88	G71048	89	G71139	90
G70104	87	G70218	88	G71049	89	G71140	90
G70105	87	G70219	88	G71050	89	G71141	90
G70106	87	G70220	88	G71051	89	G71142	90
G70107	87	G70221	88	G71052	89	G71143	90
G70108	87	G70222	88	G71053	89	G71144	90
G70109	87	G70223	88	G71054	89	G71145	90
G70110	87	G70224	88	G71055	89	G71146	90
G70111	87	G70225	88	G71056	89	G71147	90
G70112	87	G70226	88	G71057	89	G71148	90
G70113	87	G70227	88	G71058	89	G71149	90
G70114	87	G70228	88	G71059	89	G71150	90
G70115	87	G70229	88	G71060	89	G71151	90
G70116	87	G70230	88	G71061	89	G71152	90
G70117	87	G70231	88	G71062	89	G71153	90
G70118	87	G70232	88	G71063	89	G71154	90
G70119	87	G70233	88	G71064	89	G71155	90
G70120	87	G70234	88	G71066	89	G71156	90
G70121	87	G70235	88	G71067	89	G71157	90
G70122	87	G70236	88	G71068	89	G71158	90
G70123	88	G70237	88	G71069	89	G71159	90
G70124	88	G71000	89	G71070	89	G71160	90
G70125	88	G71001	89	G71071	89	G71161	90
G70126	88	G71002	89	G71072	89	G71162	90
G70127	88	G71003	89	G71074	89	G71167	90
G70128	88	G71004	89	G71075	89	G71168	90
G70129	88	G71005	89	G71076	89	G71169	90

PART NO.	PG #	PART NO.	PG #	PART NO.	PG #	PART NO.	PG #
G71170	90	G72312	91	H10156	121	H20007	123
G71172	90	G72314	91	H10158	121	H20010	123
G71173	90	G72316	91	H10208	121	H20011	123
G71174	90	G72318	91	H11054	121	H20012	123
G71176	90	G72320	91	H11056	121	H20100	123
G71177	90	G72322	91	H11058	121	H20150	123
G71179	90	G72324	91	H11074	121	H20500	123
G71401	92	G72326	91	H11076	121	H21010	123
G71402	92	G72328	91	H11078	121	H21025	123
G71403	92	G72330	91	H11080	121	H21050	123
G71404	92	G72332	91	H11106	121	H21100	123
G72100	91	G72333	91	H11108	121	H21101	123
G72101	91	G72334	91	H11126	121	H21200	123
G72102	91	G72335	91	H11156	121	H22050	122
G72103	91	G73101	92	H11208	121	H22075	122
G72104	91	G73108	92	H11210	121	H23050	121
G72105	91	G73115	92	H12054	121	H24038	122
G72107	91	G73122	92	H12056	121	H24050	122
G72108	91	G73129	92	H12074	121	H24075	122
G72109	91	G74103	92	H12076	121	H24100	122
G72110	91	G74105	92	H12106	121	H25050	122
G72111	91	G74111	92	H13038	122	H25075	122
G72112	91	G74113	92	H13050	122	H25100	122
G72113	91	G74119	92	H13075	122	H26050	122
G72114	91	G74121	92	H13100	122	H26075	122
G72115	91	G74127	92	H13125	122	H26100	122
G72116	91	G74129	92	H13150	122	H26125	122
G72117	91	G74135	92	H13200	122	H26150	122
G72118	91	G74137	92	H13250	122	H26200	122
G72119	91	G80001	403	H13300	122	H27050	122
G72120	91	G80002	403	H13400	122	H27075	122
G72121	91	G80003	403	H14050	128	H27100	122
G72122	91	G80004	403	H14075	128	H28050	123
G72123	91	G80005	403	H14100	128	H28075	123
G72124	91	G80006	403	H14125	128	H28100	123
G72126	91	G80007	403	H14150	128	H28125	123
G72127	91	G80010	404	H14200	128	H28150	123
G72128	91	G80011	404	H14250	128	H28200	123
G72129	91	G80012	404	H14300	128	H29000	123
G72130	91	G80013	404	H14400	128	H29010	123
G72131	91	G80015	404	H15001	122	H30001	121
G72132	91	G80016	404	H15050	122	H30002	121
G72133	91	G80018	400	H15075	122	H30003	121
G72134	91	G80020	396	H15100	122	H30004	121
G72135	91	G80023	395	H15125	122	H30011	121
G72136	91	G80024	395	H15150	122	H30022	121
G72137	91	G80025	395	H15200	122	H30033	121
G72140	91	G80027	395	H16038	122	H30044	121
G72141	91	G80030	400	H16050	122	H305	359
G72142	91	GI05	357	H16075	122	H307	359
G72143	91	GI07	357	H16100	122	H310	359
G72144	91	GI10	357	H17050	128	H312	359
G72146	91	GI12	357	H17075	128	H320	359
G72147	91	GI15	357	H17100	128	H40001	399
G72148	91	H10052	121	H17125	128	H40002	399, 413, 416
G72149	91	H10054	121	H17150	128	H40003	399
G72150	91	H10056	121	H17200	128	H40004	399, 413, 416
G72151	91	H10058	121	H17250	128	H500X2	307, 406
G72152	91	H10072	121	H17300	128	H54001	77
G72153	91	H10074	121	H17350	128	H54002	77
G72154	91	H10076	121	H17400	128	H54003	77
G72155	91	H10078	121	H18050	122	H54010	78
G72300	91	H10080	121	H18075	122	H54011	78
G72302	91	H10106	121	H20001	123	H54012	78
G72304	91	H10108	121	H20002	123	H54013	78
G72306	91	H10110	121	H20003	123	H54014	78
G72308	91	H10126	121	H20005	123	H54015	78
G72310	91	H10128	121	H20006	123	H54017	78

<u>PART NO.</u>	<u>PG #</u>	<u>PART NO.</u>	<u>PG #</u>	<u>PART NO.</u>	<u>PG #</u>	<u>PART NO.</u>	<u>PG #</u>
H54018	78	H70350	129	I10023	159	I12014	161
H54025	78	H70400	129	I10024	159	I12015	161
H54026	78	H72050	129	I10025	159	I12016	161
H54027	78	H72075	129	I10026	159	I12017	161
H54028	78	H72100	129	I10027	159	I12018	161
H54029	78	H72125	129	I10028	159	I13001LF	160
H54030	78	H72150	129	I10029	159	I13002LF	160
H54040	78	H72200	129	I10030	159	I13003LF	160
H54041	78	H72250	129	I10031	159	I13004LF	160
H54050	298	H72300	129	I10032	159	I13005LF	160
H54051	298	H72375	129	I10033	159	I13006LF	160
H54060	78	H72400	129	I10034	159	I13007LF	160
H54061	78	H73050	129	I10035	159	I13010LF	160
H54100	299	H73075	129	I10036	159	I13011LF	160
H56050	296	H73100	129	I10037	159	I13012LF	160
H56075	296	H73125	129	I10038	159	I13013LF	160
H60050	127	H73150	129	I10039	159	I13016LF	160
H60375	127	H73200	129	I10040	159	I13017LF	160
H60625	127	H73375	129	I10041	159	I13018LF	160
H65050	128	H80050	129	I10042	159	I13019LF	160
H65075	128	H80375	129	I10043	159	I13020LF	160
H65100	128	H81050	129	I10044	159	I13021LF	160
H65125	128	H81375	129	I10045	159	I13022LF	160
H65150	128	H82050	129	I10046	159	I13023LF	160
H65200	128	H82375	129	I10047	159	I13024LF	160
H65250	128	H83050	128	I10048	159	I13025LF	160
H65300	128	H83075	128	I10049	159	I13026LF	160
H65400	128	H83100	128	I11001	158	I13027LF	160
H65500	128	H84050	128	I11002	158	I13029LF	160
H65600	128	H84075	128	I11003	158	I13031LF	160
H66050	128	H84100	128	I11004	158	I13032LF	160
H66075	128	H85050	128	I11005	158	I13033LF	160
H66100	128	H85075	128	I11006	158	I13036LF	160
H66125	128	H90100	403, 414	I11007	158	I13037LF	160
H66150	128	H90101	403, 414	I11008	158	I50058	111
H66200	128	H90120	403, 413	I11009	158	I50075	111
H66250	128	H90122	403	I11010	158	I50078	111
H66300	128	H90123	403, 413	I11011	158	I50118	111
H66400	128	HDNHC1	314	I11012	158	I50138	111
H68050	128	HDNHC10	314	I11013	158	I50158	111
H68075	128	HDNHC2	314	I11014	158	I50178	111
H68100	128	HDNHC3	314	I11015	158	I50218	111
H68125	128	HDNHC4	314	I11016	158	I50238	111
H68150	128	HDNHC5	314	I11017	158	I50258	111
H68200	128	HDNHC6	314	I11018	158	I51058	111
H68250	128	HDNHC8	314	I11019	158	I51078	111
H68300	128	I10001	159	I11020	158	I51118	111
H68350	128	I10002	159	I11021	158	I51138	111
H68400	128	I10003	159	I11022	158	I51158	111
H68500	128	I10004	159	I11023	158	I51178	111
H68600	128	I10005	159	I11024	158	I51218	111
H68800	128	I10006	159	I11025	158	I51238	111
H69050	128	I10007	159	I11026	158	I51258	111
H69075	128	I10008	159	I11027	158	I52034	111
H69100	128	I10009	159	I11028	158	I52058	111
H69150	128	I10010	159	I12001	161	I52078	111
H69200	128	I10011	159	I12002	161	I52118	111
H69250	128	I10012	159	I12003	161	I52138	111
H69300	128	I10013	159	I12004	161	I52158	111
H69400	128	I10014	159	I12005	161	I52178	111
H70050	129	I10015	159	I12006	161	I52218	111
H70075	129	I10016	159	I12007	161	I52238	111
H70100	129	I10017	159	I12008	161	I52258	111
H70125	129	I10018	159	I12009	161	I52318	111
H70150	129	I10019	159	I12010	161	I52358	111
H70200	129	I10020	159	I12011	161	I53038	111
H70250	129	I10021	159	I12012	161	I53050	111
H70300	129	I10022	159	I12013	161	I53058	111

<u>PART NO.</u>	<u>PG #</u>	<u>PART NO.</u>	<u>PG #</u>	<u>PART NO.</u>	<u>PG #</u>	<u>PART NO.</u>	<u>PG #</u>
153075	111	160250	107	181034	108	J04004	101
153078	111	160258	107	181038	108	J04005	101
153118	111	160300	107	181050	108	J04006	101
153138	111	160318	107	181058	108	J04012	101
153158	111	160350	107	181078	108	J04016	101
153178	111	161038	107	181118	108	J04104	101
153218	111	161050	107	181138	108	J04105	101
153238	111	161058	107	181150	108	J04106	101
153258	111	161075	107	181158	108	J04204	101
153312	111	161078	107	181200	108	J04205	101
153318	111	161118	107	181218	108	J04206	101
153358	111	161138	107	181250	108	J04250	101
153412	111	161158	107	181258	108	J34712	113
153418	111	161200	107	181300	108	J34715	113
154050	111	161218	107	181318	108	J34718	113
154058	111	161250	107	181358	108	J34724	113
154075	111	161258	107	181400	108	J34800	114
154078	111	161300	107	181418	108	J34970	114
154118	111	161318	107	182034	108	J34975	114
154138	111	161350	107	182038	108	J34980	114
154158	111	161358	107	182050	108	J35712	113
154178	111	161418	107	182058	108	J35715	113
154218	111	161450	107	182078	108	J35718	113
154258	111	162038	107	182118	108	J35724	113
155058	111	162050	107	182138	108	J36018	114
155075	111	162058	107	182150	108	J36022	114
155078	111	162075	107	182158	108	J36024	114
155118	111	162078	107	182200	108	J36026	114
155158	111	162118	107	182218	108	J36030	114
155178	111	162138	107	182250	108	J36100	281
155218	111	162158	107	182258	108	J36101	281
155258	111	162200	107	182300	108	J36118	112
156058	111	162218	107	182318	108	J36124	112
156075	111	162250	107	182358	108	J36130	112
156078	111	162258	107	182400	108	J36136	112
156118	111	162300	107	182418	108	J36148	112
156138	111	162318	107	183034	108	J36200	114
156158	111	162350	107	183058	108	J36250	114
156218	111	162358	107	183078	108	J36300	114
157058	111	162418	107	183118	108	J36400	114
157078	111	162450	107	183138	108	J36500	112
157115	111	163058	107	183150	108	J36501	112
157118	111	163075	107	183158	108	J36712	113
157138	111	163078	107	183200	108	J36715	113
157158	111	163118	107	183218	108	J36718	113
157178	111	163138	107	183250	108	J36724	113
157218	111	163158	107	183258	108	J37022	114
157238	111	163200	107	183300	108	J37024	114
157258	111	163218	107	183318	108	J37026	114
159050	112	163250	107	183358	108	J37028	114
159075	112	163258	107	183418	108	J37030	114
159100	112	163300	107	1A1050	112	J37124	69, 319
159125	112	163318	107	1A1100	112	J37150	69, 319
159150	112	163350	107	1A2050	112	J38020	114
159175	112	163358	107	1A2100	112	J38022	114
159200	112	180034	108	INT001	112	J38024	114
159225	112	180038	108	INT002	112	J38026	114
160025	107	180050	108	IPC004	112	J38030	114
160038	107	180058	108	J01001	99	J38712	113
160050	107	180078	108	J01050	121	J38715	113
160058	107	180118	108	J01057	121	J38718	113
160075	107	180138	108	J01075	121	J38724	113
160078	107	180150	108	J01077	121	J39019	114
160118	107	180158	108	J01100	121	J39023	114
160138	107	180200	108	J01150	122	J39027	114
160158	107	180218	108	J01200	122	J39030	114
160200	107	180250	108	J01300	122	J39712	113
160218	107	180258	108	J01400	122	J39715	113

PART NO.	PG #	PART NO.	PG #	PART NO.	PG #	PART NO.	PG #
J39718	113	J40084	293, 404	J40286	298	J40446	304, 404
J39724	113	J40086	294	J40287	299	J40447	304, 404
J40000	281	J40087	294	J40288	297, 405, 416	J40447	420
J40001	281	J40088	294	J40305	283	J40448	304, 404
J40002	281	J40089	294	J40306	283	J40448	420
J40003	281	J40100	306	J40307	284	J40450	305
J40004	281	J40101	294	J40308	284	J40451	305
J40005	281	J40102	306, 404, 414	J40311	284	J40481	305
J40006	281	J40102	419	J40325	284	J40482	305
J40007	282	J40105	284	J40329	295	J40490	282, 422, 425
J40008	281	J40106	284	J40330	299	J40491	282, 422, 425
J40010	283, 423, 425	J40107	304, 404	J40331	299	J40500	116
J40011	283	J40111	304	J40332	299	J40501	116
J40012	283	J40115	304, 404, 414	J40333	299	J40502	116
J40013	283	J40116	304	J40334	299	J40503	116
J40015	281, 423	J40117	304	J40335	299	J40505	116
J40016	67	J40123	285	J40336	299	J40506	116
J40017	67	J40124	294, 401	J40337	299	J40510	116
J40018	283, 423	J40125	123, 294, 401	J40338	299	J40511	116
J40019	284, 422, 425	J40128	284	J40339	299	J40529	295
J40020	306	J40134	304	J40340	299	J40550	116
J40021	283, 422, 423	J40141	290	J40341	299	J40551	116
J40022	283	J40142	290	J40343	299	J40553	114
J40023	283	J40143	290	J40345	294	J40554	114
J40024	283	J40144	290	J40345	419	J40555	114
J40025	281	J40150	72	J40346	294, 405, 414	J40556	114
J40026	282, 423, 425	J40151	72	J40346	419	J40557	114
J40028	283	J40153	72	J40369	291	J40558	116
J40030	281	J40197	297	J40375	291	J40560	116
J40032	168	J40198	285	J40380	299	J40561	117
J40033	168	J40199	297	J40381	299	J40562	117
J40034	282	J40200	297	J40382	299	J40563	117
J40035	282, 422, 425	J40201	297	J40383	299	J40575	116
J40040	282	J40202	298	J40384	299	J40600	294
J40041	282	J40203	298	J40385	299	J40601	294
J40042	282	J40204	298	J40386	299	J40629	295
J40044	294	J40206	298	J40387	299	J40650	286
J40045	294	J40207	298	J40393	304, 401, 415, 416	J40651	286
J40046	294	J40208	416	J40400	290	J40652	286
J40047	294	J40208	297, 405	J40401	296	J40653	286
J40048	294	J40210	296	J40402	296	J40700	117
J40049	294	J40211	296	J40403	296	J40701	117
J40050	292	J40212	296	J40404	296	J40702	116
J40051	292	J40213	287	J40405	296	J40703	116
J40052	292	J40215	287	J40406	297	J40704	116
J40053	292	J40217	287	J40407	297	J40705	116
J40054	292	J40218	287	J40408	297	J40750	291
J40055	292	J40219	287	J40410	296	J40775	291
J40060	294	J40220	292	J40411	296	J40800	291
J40061	294	J40221	292	J40429	295	J40801	296
J40062	294	J40222	292	J40430	295	J40802	296
J40063	294	J40223	284	J40431	295	J40803	296
J40065	284	J40224	284	J40432	295	J40804	296
J40066	284	J40225	284	J40433	304, 404	J40805	296
J40067	284	J40228	287	J40434	304, 404	J40806	296
J40068	284	J40229	295	J40434	420	J40807	296
J40069	284	J40230	284	J40435	304, 404	J40808	296
J40070	284	J40235	283, 425	J40435	420	J40812	295
J40071	284	J40240	286	J40436	304, 404	J40830	286, 423, 425
J40072	284	J40241	286	J40437	304, 404	J40831	286, 425
J40073	284	J40242	286	J40437	420	J40950	292
J40074	284	J40243	286	J40438	304, 404	J40951	292
J40075	284, 425	J40244	286	J40438	420	J40952	292
J40076	284	J40260	287, 422, 425	J40443	304, 404	J40953	292
J40077	284	J40261	287, 422, 425	J40444	304, 404	J40954	292
J40078	284	J40262	287, 425	J40444	420	J40955	292
J40079	284	J40263	287	J40445	304, 404	J40960	292
J40080	292, 423, 425	J40285	298	J40445	420	J40965	292

<u>PART NO.</u>	<u>PG #</u>	<u>PART NO.</u>	<u>PG #</u>	<u>PART NO.</u>	<u>PG #</u>	<u>PART NO.</u>	<u>PG #</u>
J40966	292	K101010390	373	K151010092	363	K151150058	363
J40967	291	K101050100	373	K151010100	363	K151150100	363
J41008	290	K101750100	373	K151010106	363	K151150150	363
J41009	290	K102550050	373	K151010107	363	K151150215	363
J41010	290	K102550058	373	K151010150	363	K151150295	363
J41011	290	K102550100	373	K151010157	363	K151150390	363
J41021	295	K102550150	373	K151010158	363	K151400007	366
J41022	295	K102570050	373	K151010159	363	K151400032	366
J41023	295	K102570058	373	K151010160	363	K151400058	366
J41024	295	K102570100	373	K151010215	363	K151400059	366
J41030	305	K102570107	373	K151010221	363	K151400107	366
J41031	305	K102570150	373	K151010222	363	K151400108	366
J41032	305	K102590050	373	K151010223	363	K151400149	366
J41103	292	K102590058	373	K151010295	363	K151400159	366
J41104	292	K102600050	373	K151010302	363	K151400160	366
J41105	292	K104670050	373	K151010303	363	K151400222	366
J41106	292	K104800050	374	K151010304	363	K151400223	366
J41107	292	K104800057	374	K151010390	363	K151400303	366
J41108	292	K104800058	374	K151010398	363	K151400398	366
J41201	296	K104800100	374	K151010399	363	K151420060	363
J41202	296	K104800107	374	K151010520	363	K151540001	365
J41205	296	K104800159	374	K151010531	363	K151540002	365
J41206	296	K104800160	374	K151010650	363	K151540025	365
J41210	296, 401	K104800222	374	K151010860	363	K151540050	365
J42002	291	K104800223	374	K151050001	363	K151540090	365
J42003	291	K104800224	374	K151050002	363	K151540100	365
J42004	291	K104820050	373	K151050006	363	K151540150	365
J42008	294	K104920050	374	K151050024	363	K151540215	365
J42012	294	K104920100	374	K151050025	363	K151540295	365
J42101	306	K104920143	374	K151050031	363	K151540390	365
J42200	306	K104980118	374	K151050032	363	K151540520	365
J43300	413, 416	K113420215	378	K151050050	363	K151540650	365
J43300	400	K113420520	378	K151050056	363	K151540860	365
J43310	400	K113420650	378	K151050057	363	K151541100	365
J44050	285, 424, 425	K113420860	378	K151050058	363	K151650001	364
J44075	285, 424	K113450390	378	K151050059	363	K151650002	364
J44100	285, 424, 425	K113450650	378	K151050060	363	K151650007	364
J44150	285, 424, 425	K113450860	378	K151050092	363	K151650008	364
J44200	285, 424, 425	K126570215	367	K151050093	363	K151650015	364
J44300	285, 424, 425	K126570295	367	K151050100	363	K151650025	364
J44400	285, 424, 425	K126570390	367	K151050106	363	K151650032	364
J44661	283	K126570520	367	K151050107	363	K151650033	364
J45005	309	K126570650	367	K151050150	363	K151650050	364
J45010	282, 422, 425	K126610050	374	K151050158	363	K151650058	364
J45015	283, 423, 425	K126610100	374	K151050159	363	K151650059	364
J45100	301	K126610150	374	K151050160	363	K151650090	364
J60004	273	K126610215	374	K151050215	363	K151650093	364
J60005	273	K126610295	374	K151050221	363	K151650094	364
J60007	273	K126610390	374	K151050222	363	K151650095	364
J60008	273	K126650050	374	K151050223	363	K151650100	364
J60010	274	K126650100	374	K151050295	363	K151650107	364
J60011	274	K126650150	374	K151050302	363	K151650108	364
J60012	274	K126650215	374	K151050303	363	K151650109	364
J60026	273	K126650295	374	K151050390	363	K151650149	364
J60027	273	K151010001	363	K151050398	363	K151650150	364
J60030	270	K151010002	363	K151050520	363	K151650159	364
J60060	259	K151010005	363	K151050650	363	K151650160	364
J60061	259	K151010006	363	K151140025	363	K151650161	364
J60062	259	K151010007	363	K151140050	363	K151650215	364
J60094	273	K151010024	363	K151140057	363	K151650222	364
J66300	115	K151010025	363	K151140100	363	K151650223	364
J66301	115	K151010031	363	K151140150	363	K151650224	364
J66302	115	K151010032	363	K151140215	363	K151650295	364
K01120	399, 413	K151010050	363	K151140295	363	K151650303	364
K012000	399	K151010056	363	K151140390	363	K151650304	364
K101010050	373	K151010057	363	K151150002	363	K151650305	364
K101010100	373	K151010058	363	K151150050	363	K151650306	364
K101010295	373	K151010059	363	K151150057	363	K151650390	364

<u>PART NO.</u>	<u>PG #</u>	<u>PART NO.</u>	<u>PG #</u>	<u>PART NO.</u>	<u>PG #</u>	<u>PART NO.</u>	<u>PG #</u>
K151650398	364	K152350160	365	K152901100	366	K154600059	368
K151650399	364	K152350215	365	K152950002	366	K154600060	368
K151650400	364	K152350222	365	K152950025	366	K154600066	368
K151650401	364	K152350223	365	K152950050	366	K154600068	368
K151650402	364	K152350295	365	K152950090	366	K154600075	368
K151650520	364	K152350303	365	K152950100	366	K154600090	368
K151650531	364	K152350390	365	K152950150	366	K154600092	368
K151650532	364	K152350398	365	K152950215	366	K154600095	368
K151650533	364	K152350520	365	K152950295	366	K154600100	368
K151650534	364	K152350650	365	K152950390	366	K154600106	368
K151650650	364	K152350780	365	K152950520	366	K154600107	368
K151650662	364	K152350860	365	K152950650	366	K154600108	368
K151650663	364	K152350975	365	K152950860	366	K154600109	368
K151650664	364	K152351100	365	K153960050	366	K154600117	368
K151650780	364	K152351225	365	K153960150	366	K154600118	368
K151650860	364	K152420001	365	K154100007	367	K154600127	368
K151650870	364	K152420002	365	K154100032	367	K154600150	368
K151650871	364	K152420015	365	K154100058	367	K154600157	368
K151650872	364	K152420025	365	K154100059	367	K154600158	368
K151650873	364	K152420050	365	K154100093	367	K154600159	368
K151650874	364	K152420090	365	K154100094	367	K154600160	368
K151651100	364	K152420100	365	K154100107	367	K154600161	368
K151651109	364	K152420150	365	K154100108	367	K154600169	368
K151651111	364	K152420215	365	K154100109	367	K154600170	368
K151651225	364	K152420295	365	K154100149	367	K154600171	368
K151651498	364	K152420390	365	K154100159	367	K154600180	368
K151670050	364	K152420520	365	K154100160	367	K154600181	368
K151700001	364	K152420650	365	K154100222	367	K154600182	368
K151700002	364	K152420860	365	K154100223	367	K154600215	368
K151700025	364	K152540002	365	K154100224	367	K154600220	368
K151700050	364	K152540025	365	K154100303	367	K154600221	368
K151700090	364	K152540050	365	K154100304	367	K154600222	368
K151700100	364	K152540090	365	K154100305	367	K154600223	368
K151700150	364	K152540100	365	K154100306	367	K154600224	368
K151700215	364	K152540150	365	K154100398	367	K154600234	368
K151700295	364	K152540215	365	K154100399	367	K154600235	368
K151700390	364	K152540295	365	K154100400	367	K154600236	368
K151700520	364	K152540390	365	K154100401	367	K154600237	368
K151700650	364	K152540520	365	K154100402	367	K154600245	368
K151700780	364	K152540650	365	K154100531	367	K154600246	368
K151700860	364	K152540860	365	K154100532	367	K154600247	368
K151700975	364	K152670050	365	K154100533	367	K154600248	368
K151701100	364	K152670100	365	K154100534	367	K154600256	368
K151720001	364	K152720002	366	K154100662	367	K154600295	368
K151720002	364	K152720025	366	K154100663	367	K154600302	368
K151720025	364	K152720050	366	K154100664	367	K154600303	368
K151720050	364	K152720090	366	K154100665	367	K154600304	368
K151720090	364	K152720100	366	K154100869	367	K154600305	368
K151720100	364	K152720150	366	K154100870	367	K154600306	368
K151720150	364	K152720215	366	K154100871	367	K154600315	368
K151720215	364	K152720295	366	K154100872	367	K154600316	368
K151720295	364	K152720390	366	K154100983	367	K154600317	368
K151720390	364	K152720520	366	K154101498	367	K154600318	368
K151720520	364	K152720860	366	K154600001	368	K154600319	368
K151720650	364	K152900001	366	K154600002	368	K154600328	368
K151720860	364	K152900002	366	K154600006	368	K154600329	368
K151720975	364	K152900025	366	K154600007	368	K154600330	368
K152350001	365	K152900050	366	K154600012	368	K154600331	368
K152350002	365	K152900090	366	K154600013	368	K154600332	368
K152350025	365	K152900100	366	K154600025	368	K154600339	368
K152350032	365	K152900150	366	K154600031	368	K154600340	368
K152350050	365	K152900215	366	K154600032	368	K154600341	368
K152350059	365	K152900295	366	K154600033	368	K154600342	368
K152350090	365	K152900390	366	K154600041	368	K154600343	368
K152350100	365	K152900520	366	K154600050	368	K154600350	368
K152350107	365	K152900650	366	K154600056	368	K154600352	368
K152350150	365	K152900860	366	K154600057	368	K154600390	368
K152350159	365	K152900975	366	K154600058	368	K154600397	368

<u>PART NO.</u>	<u>PG #</u>	<u>PART NO.</u>	<u>PG #</u>	<u>PART NO.</u>	<u>PG #</u>	<u>PART NO.</u>	<u>PG #</u>
K154600398	368	K154600893	369	K208400664	377	L26008	408, 415
K154600399	368	K154600895	369	K208450295	377	L26008	419
K154600400	368	K154600896	369	K208450650	377	L26009	415
K154600401	368	K154600914	369	K245500295	377	L26010	419
K154600402	368	K154600975	369	K245500390	377	L26015	408, 415
K154600413	368	K154601100	369	K245510215	377	L26015	419
K154600414	368	K154601109	369	K245510295	377	L26016	419
K154600415	368	K154601111	369	K245510390	377	L26017	419
K154600416	368	K154601113	369	K245540295	377	L26018	415
K154600417	368	K154601225	369	K50001	288	L26018	419
K154600418	368	K154601498	368	K50002	288	L40001	124
K154600429	368	K155330050	366	K50003	288	L40002	124
K154600430	368	K155330090	366	K50005	288	L42006	124
K154600431	368	K155330100	366	K50011	300, 402	L42008	124
K154600432	368	K155330150	366	K50011	421	L42011	306
K154600433	368	K155330215	366	K50012	300	L42012	306
K154600444	368	K155330295	366	K50012	421	L42013	306
K154600447	368	K155330390	366	K50015	300, 402	L42014	306
K154600457	368	K156570050	367	K50016	300, 402	L42015	306
K154600470	368	K156570100	367	K50017	300, 402	L42016	306
K154600520	368	K156570150	367	K50018	300, 402	L42017	306
K154600531	369	K159470001	367	K50018	421	L42018	306
K154600532	369	K159470002	367	K50020	300, 402	L42019	306
K154600533	369	K159470025	367	K50020	421	L42023	306
K154600534	369	K159470050	367	K50041	288	L42052	124
K154600535	369	K159470090	367	K50042	288	L42102	124
K154600536	369	K159470100	367	K50043	288, 402	L42103	124
K154600548	369	K159470150	367	K50043	419	L42104	124
K154600549	369	K159470215	367	K50045	300, 402	L47001	85
K154600550	369	K159470295	367	K50046	288, 402	L47004	85
K154600551	369	K159470390	367	K50046	419	L56020	74
K154600552	369	K201010215	376	K52001	73	L56023	74
K154600553	369	K201010295	376	K52002	73	L56024	74
K154600554	369	K201010390	376	K52003	73	L56026	74
K154600564	369	K201010650	376	K52004	73	L56027	74
K154600565	369	K201050295	376	K52005	73	L65001	73
K154600566	369	K201050650	376	K52010	4, 73	L75001	276
K154600580	369	K201100390	376	K52011	4	L75002	276
K154600583	369	K201610215	376	K52013	4	L75006	276
K154600595	369	K201610295	376	K52014	4	L75007	276
K154600608	368	K201610390	376	K52016	4	L75009	277
K154600650	369	K201620215	376	K52017	4	L75010	277
K154600662	369	K201620650	376	K53001	73	L75015	277
K154600663	369	K202350398	376	K53002	73	L75016	277
K154600664	369	K202350650	376	K53003	73	L75017	277
K154600665	369	K202950650	376	K53004	73	L75018	277
K154600666	369	K203100295	376	K53005	73	L75019	277
K154600667	369	K204600215	376	K53006	73	L75020	277
K154600668	369	K204600295	376	K53007	73	L75021	277
K154600677	369	K204600390	376	K53008	73	L75022	277
K154600678	369	K204600398	376	K53055	73	L75023	277
K154600679	369	K204600414	376	K53056	73	L75024	277
K154600680	369	K204650295	377	K53057	73	L75040	276
K154600682	369	K204650390	377	K53058	73	L75041	276
K154600693	369	K204650398	377	K53060	73	L75042	276
K154600694	369	K204650695	377	K53077	73	L75043	276
K154600695	369	K204800295	376	K55006	73	L75080	276
K154600696	369	K204850295	377	K55007	73	L75081	276
K154600708	369	K204850390	377	L26001	419	L75085	276
K154600860	369	K205220390	377	L26002	415	L75086	276
K154600870	369	K208400215	377	L26003	408	L75091	276
K154600871	369	K208400295	377	L26003	419	L75092	276
K154600872	369	K208400303	377	L26004	419	L75095	276
K154600873	369	K208400390	377	L26005	408, 415	L75096	276
K154600874	369	K208400398	377	L26005	419	L75180	276
K154600875	369	K208400399	377	L26006	408, 415	L75181	276
K154600876	369	K208400413	377	L26007	415	L75185	276
K154600877	369	K208400650	377	L26007	419	L75186	276

PART NO.	PG #	PART NO.	PG #	PART NO.	PG #	PART NO.	PG #
L75400	277	M25536	291	N14002	157	N20006	148
L75401	277	M25560	291	N14003	157	N20007	148
L75402	277	M25736	291	N14004	157	N20008	148
L75403	277	M25760	291	N14005	157	N20009	148
L75406	277	M25772	291	N14006	157	N20010	148
L75407	277	M25784	291	N14007	157	N20012	148
L75408	277	M25900	130, 284	N14008	157	N20014	148
L75409	277	M301	359	N14009	157	N21000	148
L75908	276	M302	359	N14010	157	N21001	148
L75909	276	M303	359	N14011	157	N21002	148
L95200	313	M305	359	N14012	157	N21003	148
L95201	313	M307	359	N14013	157	N21004	148
L95202	313	M310	359	N14014	157	N21005	148
L95400	309	M312	359	N14015	157	N21006	148
L95500	398, 414	M315	359	N14016	157	N21007	148
LLPRODISP	426	M320	359	N14017	157	N21008	148
M05001	86, 126, 271	M325	359	N14018	157	N21009	148
M05003	86, 271	M330	359	N14019	157	N21010	148
M05003	126	M340	359	N15001	157	N21014	148
M05005	86, 126	M60001	85	N15100	152	N21022	148
M05034	241	M60002	85	N15150	152	N22000	148
M05134	241	M60003	85	N15200	152	N22001	148
M06001	130	N01001	164	N15250	152	N22002	148
M06002	130	N01002	164	N15300	152	N22003	148
M06006	131	N01010	163	N15350	152	N22004	148
M06007	131	N01011	163	N15400	152	N22005	148
M06010	131	N01014	163	N15450	152	N22006	148
M07001	130	N01027	163	N15500	152	N22007	148
M07002	130	N01028	163	N15550	152	N22008	148
M101	359	N01029	163	N15600	152	N22009	148
M102	359	N01032	164	N15900	152	N22010	148
M103	359	N01033	164	N16100	152	N22014	148
M105	359	N01034	164	N16150	152	N22018	148
M107	359	N01038	162	N16200	152	N22022	148
M110	359	N01039	162	N16250	152	N2206BN	23
M112	359	N06001	157	N16300	152	N2206RB	23
M115	359	N07001	157	N16350	152	N2206WB	23
M120	359	N09001	157	N16400	152	N2210BN	23
M12001	130	N09002	157	N16450	152	N2210PB	23
M12002	130	N10001	157	N16500	152	N2210RB	23
M12003	130	N10002	157	N16550	152	N23000	148
M12004	130	N10003	157	N16600	152	N23001	148
M12005	130, 131	N10004	157	N16900	152	N23002	148
M12006	130, 131	N10005	157	N16918	152	N23003	148
M12007	131	N10006	157	N16924	152	N23004	148
M12009	130	N10007	157	N16936	152	N23005	148
M12022	130	N10008	157	N17050	23	N23006	148
M12085	130	N10442LF	162	N17100	152	N23007	148
M12100	130	N10444LF	162	N17150	152	N23008	148
M125	359	N10544LF	162	N17300	152	N23009	148
M130	359	N10566LF	162	N17375	23	N23010	148
M140	359	N10664LF	162	N17400	152	N23012	148
M15001	131	N10944LF	162	N17600	152	N23014	148
M15002	131	N11001	157	N18001	157	N23016	148
M15005	131	N11002	157	N18002	157	N23018	148
M15009	131	N11003	157	N18100	152	N23020	148
M20058	130	N11004	157	N18200	152	N23022	148
M20075	130	N11005	157	N18250	152	N2306BN	23
M20100	130	N11006	157	N18300	152	N2306RB	23
M20101	130	N11007	157	N18400	152	N2306WB	23
M20581	130	N11008	157	N18500	152	N2310BN	23
M20751	130	N12001	157	N18600	152	N2310PB	23
M25100	291	N12002	157	N20000	148	N2310RB	23
M25127	291	N12003	157	N20001	148	N2310WB	23
M25130	291	N12004	157	N20002	148	N24000	148
M25136	291	N12005	157	N20003	148	N24001	148
M25148	291	N12006	157	N20004	148	N24002	148
M25527	291	N14001	157	N20005	148	N24003	148

PART NO.	PG #	PART NO.	PG #	PART NO.	PG #	PART NO.	PG #
N24004	148	N29020	149	O25310	48	P13624	141
N24005	148	N29022	149	P10001	285	P13632	141
N24006	148	N30000	149	P10002	285	P13986	140
N24007	148	N30004	149	P10012	140	P15050	240
N24008	148	N30005	149	P10014	140	P15075	240
N24009	148	N30006	149	P10016	140	P15175	240
N24010	148	N30007	149	P10018	140	P16002	140
N24012	148	N30008	149	P10032	140	P16004	140
N24014	148	N30010	149	P10034	140	P16006	140
N24016	148	N31000	149	P10036	140	P16008	140
N24018	148	N31004	149	P10038	140	P19062	140
N24022	148	N31005	149	P10082	140	P19082	140
N25000	148	N31006	149	P10084	140	P19084	140
N25002	148	N31008	149	P10086	140	P19086	140
N25003	148	N31010	149	P10088	140	P19128	140
N25004	148	N62006LF	136	P10092	140	P20002	140
N25005	148	N62086LF	136	P10094	140	P20004	140
N25006	148	N62106LF	136	P10096	140	P20006	140
N25007	148	N65106LF	136	P10098	140	P20008	140
N25008	148	N66066LF	136	P10312	140	P20092	141
N25009	148	N66068LF	136	P10452	140	P20094	141
N25010	148	N66088LF	136	P10454	140	P20096	141
N25012	148	N66610LF	136	P10812	140	P20098	141
N25014	148	N68066LF	136	P10912	140	P21100	69
N25016	148	N68068LF	136	P11042	141	P21101	69
N25018	148	N68088LF	136	P11062	141	P21102	69
N25022	148	N69066LF	136	P11064	141	P21103	69
N27000	148	N69068LF	136	P11082	141	P21104	69
N27002	148	N70016	302	P11084	141	P21107	69
N27003	148	N70020	302	P11086	141	P21150	69
N27004	148	N70024	302	P11102	141	P22100	241
N27005	148	N70032	302	P11104	141	P22101	241
N27006	148	N70050	302	P11106	141	P22200	241
N27007	148	N70066LF	136	P11108	141	P22201	241
N27008	148	N70068LF	136	P11122	141	P22300	241
N27009	148	N70075	302	P11124	141	P24001	222, 257, 395, 414, 416
N27010	148	N70086LF	136	P11126	141	P24002	222, 257, 395, 414, 416
N27014	148	N70150	302	P11128	141	P24003	222, 257, 395
N27016	148	N70175	302	P11202	141	P24004	222, 257, 395, 414, 416
N27018	149	N70200	302	P11204	141	P27001	291
N27022	149	N70250	302	P11206	141	P27003	291
N28000	149	N70300	302	P11208	141	P27004	291
N28002	149	N70500	302	P11928	141	P27005	291
N28003	149	N70575	302	P11964	141	P27040	291
N28004	149	O15001	124	P11986	141	P27048	291
N28005	149	O15002	124	P12102	140	P3450BN	6
N28006	149	O15003	124	P12104	140	P3450CP	6
N28007	149	O15006	124	P12106	140	P3450RB	6
N28008	149	O15007	124	P12108	140	P35000	68
N28009	149	O25199	72	P12112	140	P35001	6, 333
N28010	149	O25200	72	P12202	141	P35001	68
N28014	149	O25202	48	P12204	141	P35002	6, 333
N28016	149	O25203	48	P12206	141	P35003	6, 68
N28018	149	O25204	48	P12208	141	P35004	68, 333
N28022	149	O25205	48	P12212	141	P35005	68, 333
N29000	149	O25206	48	P12328	141	P3500BN	6
N29003	149	O25207	48	P12342	141	P3500PB	6
N29004	149	O25208	48	P12362	141	P3500RB	6
N29005	149	O25209	48	P12364	141	P3500WB	6
N29006	149	O25210	48	P12386	141	P35033	6
N29007	149	O25302	48	P12402	140	P3503BN	6
N29008	149	O25303	48	P12404	140	P3503RB	6
N29009	149	O25304	48	P12408	140	P3503WB	6
N29010	149	O25305	48	P13224	141	P35041	68
N29012	149	O25306	48	P13232	141	P35044	6
N29014	149	O25307	48	P13424	141		
N29016	149	O25308	48	P13432	141		
N29018	149	O25309	48	P13600	285		

PART NO.	PG #	PART NO.	PG #	PART NO.	PG #	PART NO.	PG #
P3504BN	6	P3561PS	15	P36002	62	P3750BS	18
P3504RB	6	P3561PW	15	P36003	62	P3750PN	18
P3504WB	6	P3561RB	15	P36004	62	P3750PS	18
P35050	14, 15	P3561WB	15	P36102	69, 329	P3750PW	18
P35051	14	P3562AB	14	P36103	69, 329	P3750RB	18
P35052	14	P3562AL	14	P36104	331	P3750WB	18
P35055	14	P3562AN	14	P36105	331	P37511	18, 332
P35056	14, 62	P3562BI	14	P36125	6	P37512	332
P35057	62	P3562BL	14	P36150	6	P37514	332
P35058	14	P3562BN	14	P37000	335	P37515	332
P35060	14, 62	P3562BS	14	P37001	326	P37517	332
P35061	14, 62	P3562PN	14	P37002	326	P37518	332
P35062	14, 62	P3562PS	14	P37003	326	P3751AB	18
P35063	14, 62	P3562PW	14	P37004	326	P3751AL	18
P35064	14, 62	P3562RB	14	P37005	326	P3751AN	18
P35065	14	P3562WB	14	P37006	326	P3751BI	18
P35066	15, 62	P3563AB	14	P37007	326	P3751BL	18
P35067	15, 62	P3563AL	14	P37008	326	P3751BN	18
P35068	14, 15	P3563AN	14	P37009	326	P3751BS	18
P35070	14, 62	P3563BI	14	P37010	327	P3751PN	18
P35071	14	P3563BL	14	P37011	327	P3751PS	18
P35072	14	P3563BN	14	P37012	327	P3751PW	18
P35073	14	P3563BS	14	P37013	327	P3751RB	18
P35077	62	P3563PN	14	P37014	327	P3751WB	18
P35125	62	P3563PS	14	P37015	327	P37520	332
P35150	62	P3563PW	14	P37016	327	P3752AB	18
P35158	62	P3563RB	14	P37017	327	P3752AL	18
P35159	75	P3563WB	14	P37018	327	P3752AN	18
P35160	62	P3565AB	13	P37019	328	P3752BI	18
P35161	62	P3565AL	13	P37020	328	P3752BL	18
P35162	75	P3565AN	13	P37021	328	P3752BN	18
P35163	76	P3565BI	13	P37022	328	P3752PN	18
P35165	76	P3565BL	13	P37023	328	P3752PS	18
P35166	76	P3565BN	13	P37024	328	P3752PW	18
P35167	76	P3565BS	13	P37025	328	P3752RB	18
P35170	14, 62	P3565PN	13	P37026	328	P3752WB	18
P35171	14	P3565PS	13	P37027	328	P37550	19
P35172	14	P3565PW	13	P37028	328	P3755BN	19
P35175	62	P3565RB	13	P37029	328	P3755PB	19
P35180	75	P3565WB	13	P37030	327	P3755RB	19
P35260	62	P3566AB	13	P37031	327	P3755WB	19
P3560AB	15	P3566AL	13	P37032	326	P3755WH	19
P3560AL	15	P3566AN	13	P37033	328	P3761AB	18
P3560AN	15	P3566BI	13	P37034	326	P3761AL	18
P3560BI	15	P3566BL	13	P37035	328	P3761AN	18
P3560BL	15	P3566BN	13	P37036	326	P3761BI	18
P3560BN	15	P3566BS	13	P37040	327	P3761BL	18
P3560BS	15	P3566PN	13	P37041	327	P3761BN	18
P3560PN	15	P3566PS	13	P37042	326	P3761BS	18
P3560PS	15	P3566PW	13	P37118	327	P3761PN	18
P3560PW	15	P3566RB	13	P37150	328	P3761PS	18
P3560RB	15	P3566WB	13	P37200	328	P3761PW	18
P3560WB	15	P35900	68	P37400	328	P3761RB	18
P35610	14, 15	P35901	68	P37445	328	P3761WB	18
P35611	14, 15	P35902	68	P37490	328	P38001	319
P35612	14	P35904	68	P37500	18, 332	P38002	319
P35613	14	P35905	68	P37502	18, 332	P38002B	319
P35614	14	P35906	68	P37503	18, 332	P38003	319
P35615	13	P35907	68	P37505	18, 332	P38003B	319
P35616	12	P35908	68	P37506	18, 332	P38004	319
P3561AB	15	P35909	68	P37508	18, 332	P38005	319
P3561AL	15	P35910	68	P37509	18, 332	P38005B	319
P3561AN	15	P35911	68	P3750AB	18	P38006	319
P3561BI	15	P35912	68	P3750AL	18	P38006B	319
P3561BL	15	P35913	68	P3750AN	18	P38007	319
P3561BN	15	P35920	6	P3750BI	18	P38008	319
P3561BS	15	P35921	6	P3750BL	18	P38009	319
P3561PN	15	P35922	6	P3750BN	18	P38009B	319

PART NO.	PG #	PART NO.	PG #	PART NO.	PG #	PART NO.	PG #
P38010	319	P38076	323	P38162	323	P39506	18, 332
P38010B	319	P38077	323	P38163	324	P39508	18, 332
P38011	319	P38078	323	P38164	324	P39509	18, 332
P38012	319	P38079	323	P38165	324	P3950AB	18
P38012B	319	P38080	323	P38166	324	P3950AL	18
P38013	320	P38081	323	P3819BN	7	P3950AN	18
P38014	320	P38082	323	P3819RB	7	P3950BI	18
P38015	320	P38083	323	P38217	322	P3950BL	18
P38016	320	P38084	323	P38238	322	P3950BN	18
P38017	320	P38085	323	P38257	324	P3950BS	18
P38018	320	P38086	323	P38406	325	P3950PN	18
P38019	320	P38087	323	P38420	325	P3950PS	18
P38020	320	P38088	323	P38428	325	P3950PW	18
P38021	321	P38089	323	P38443	325	P3950RB	18
P38022	321	P38091	319	P38444	325	P3950WB	18
P38023	321	P38092	319	P38447	325	P39511	18, 332
P38024	321	P38093	319	P38454	325	P39512	332
P38025	321	P38094	319	P38458	325	P39514	332
P38026	321	P38095	320	P38459	325	P39515	332
P38027	321	P38096	320	P38460	325	P39517	332
P38028	321	P38097	320	P38486	325	P39518	332
P38029	321	P38098	321	P38489	325	P3951AB	18
P38030	322	P38099	321	P3892BN	6	P3951AL	18
P38031	322	P38100	321	P3892PB	6	P3951AN	18
P38032	322	P38101	321	P3892RB	6	P3951BI	18
P38033	322	P38102	321	P3892WB	6	P3951BL	18
P38034	322	P38103	321	P39000	335	P3951BN	18
P38035	322	P38104	321	P39001	329	P3951BS	18
P38036	322	P38105	321	P39002	329	P3951PN	18
P38037	322	P38106	321	P39003	329	P3951PS	18
P38038	322	P38107	320	P39004	329	P3951PW	18
P38039	322	P38108	320	P39005	329	P3951RB	18
P38040	322	P38109	320	P39006	329	P3951WB	18
P38041	322	P38110	320	P39007	329	P3952AB	18
P38042	322	P38111	320	P39008	329	P3952AL	18
P38043	322	P38112	320	P39009	329	P3952AN	18
P38044	322	P38113	321	P39010	329	P3952BI	18
P38045	322	P38114	321	P39011	329	P3952BL	18
P38046	322	P38115	322	P39012	330	P3952BN	18
P38047	322	P38116	322	P39013	330	P3952PN	18
P38048	322	P38117	322	P39014	330	P3952PS	18
P38049	322	P38118	323	P39015	330	P3952PW	18
P38050	322	P38119	323	P39016	330	P3952RB	18
P38051	322	P38120	323	P39017	330	P3952WB	18
P38052	322	P38121	323	P39018	330	P3961AB	18
P38053	322	P38122	323	P39019	330	P3961AL	18
P38054	322	P38123	323	P39020	330	P3961AN	18
P38055	322	P38124	323	P39021	330	P3961BI	18
P38056	322	P38125	323	P39022	330	P3961BL	18
P38057	322	P38126	323	P39023	331	P3961BN	18
P38058	322	P38127	323	P39024	331	P3961PN	18
P38059	322	P38128	323	P39025	331	P3961PS	18
P38060	322	P38129	320	P39026	331	P3961PW	18
P38061	322	P38130	320	P39027	331	P3961RB	18
P38062	323	P38131	323	P39028	331	P3961WB	18
P38063	324	P38132	323	P39029	331	P40004	301
P38064	324	P38133	323	P39030	330	P40014	301
P38065	323	P38134	323	P39031	330	P40080	301
P38066	323	P38135	323	P39032	329	P48002	226
P38067	323	P38136	323	P39033	330	P48003	226
P38068	323	P38137	320	P39034	329	P48004	226
P38069	323	P38138	319	P39035	331	P48102	226
P38070	323	P38140	320	P39040	331	P48103	226
P38071	323	P38141	320	P39041	331	P48104	226
P38072	323	P38142	320	P39500	18, 332	P48400	230
P38073	323	P38143	324	P39502	18, 332	P49002	230
P38074	323	P38148	324	P39503	18, 332	P49003	230
P38075	323	P38150	319	P39505	18, 332	P49004	230

<u>PART NO.</u>	<u>PG #</u>	<u>PART NO.</u>	<u>PG #</u>	<u>PART NO.</u>	<u>PG #</u>	<u>PART NO.</u>	<u>PG #</u>
P49015	230	P56600	266	PDT542	345	PFL730	342
P49025	230	P58150	267	PDT543	345	PFL814	342
P49035	230	P58200	267	PDT621	344	PFL815	342
P49250	230	P58250	267	PDT715	346	PFL815L	342
P49350	230	P58300	267	PDY415	344	PFL820	342
P49915	230	P58350	267	PDY420	344	PFL820L	342
P49920	230	P58400	267	PDY430	344	PFL821	342
P49925	230	P59300	267	PDY440	344	PFL830	342
P49930	230	P59333	267	PDY442	344	PFL830L	342
P49935	230	P59350	267	PDY443	344	PFL834	342
P49940	230	P59355	267	PEJ530	347	PFL840	342
P50100	266	P59400	267	PEJ540	347	PFL840L	342
P50125	266	P59444	267	PFA311	341	PFL860	342
P50150	266	P60001	296, 422	PFA314	341	PFL915	342
P50200	266	P60002	296	PFA315	341	PFL930	342
P50250	266	P60003	296	PFA320	341	PFY015	343
P50300	266	P70001	286	PFA330	341	PFY020	343
P50350	266	P70002	286	PFA340	341	PFY021	343
P50400	266	P70005	286	PFA360	341	PFY023	343
P50500	266	P70006	286	PFA614	342	PFY030	343
P50600	266	P70010	286	PFA615	341	PFY031	343
P50800	266	P70011	286	PFA619	342	PFY032	343
P50999	266	P70012	286	PFA620	341	PFY040	343
P51150	266	P70015	286	PFA629	342	PFY041	343
P51200	266	P70016	286	PFA630	341	PFY042	343
P51250	266	P70018	286, 422, 425	PFA639	342	PFY043	343
P51300	266	P70019	286, 422, 425	PFA640	341	PFY060	343
P51350	266	P70020	286	PFA659	342	PFY064	343
P51400	266	P70023	286	PFB211	341	PFY515L	344
P51500	266	P70029	286	PFB221	341	PFY520L	344
P51600	266	P70030	286	PFB231	341	PFY521	344
P51800	266	P70031	286	PFB232	341	PFY530L	344
P52150	266	P70035	286, 422, 425	PFB242	341	PFY531	344
P52200	266	P70036	286	PFB243	341	PFY532	344
P52250	266	P70050	286	PFB264	341	PFY540L	344
P52300	266	P70051	287	PFC114	341	PFY542	344
P52350	266	P70052	287, 422, 425	PFC115	341	PFY543	344
P52400	266	P70053	287	PFC116	341	PHA520	347
P52500	266	P70055	286	PFC120	341	PHA521	347
P53150	266	P70056	286, 287, 422	PFC121	341	PHA530	347
P53200	266	P70060	287	PFC122	341	PHA540	347
P53250	266	P70064	287, 422, 425	PFC130	341	PHA543	347
P53300	266	P70065	287	PFC131	341	PHC151	343
P53350	266	P70066	287	PFC132	341	PHC152	343
P53400	266	P70067	287, 422	PFC133	341	PHC153	343
P53500	266	P70069	287	PFC140	341	PHC154	343
P54150	267	PAB243	347	PFC142	341	PMA414	341
P54200	267	PAB75340	347	PFC143	341	PMA415	341
P54250	267	PAC543	347	PFC144	341	PMA420	341
P54300	267	PCB934	346	PFC160	341	PMA430	341
P54350	267	PCT315	344	PFL031	342	PMA440	341
P54400	267	PCT320	344	PFL032	342	PNH120	347
P54500	267	PCT330	344	PFL131	342	PNH130	347
P54600	267	PCT340	344	PFL151	343	PNH140	347
P54800	267	PCT416	344	PFL520	343	PPT015	346
P55150	266	PCT421	344	PFL530	343	PPT020	346
P55250	266	PCT431	344	PFL540	343	PPT030	346
P55300	124, 266	PCT441	344	PFL560	343	PPT040	346
P55350	266	PDL716	343	PFL614	343	PPT315	345
P55500	266	PDL722	343	PFL615	343	PPT320	345
P56200	266	PDL736	343	PFL615S	343	PPT415	346
P56250	266	PDT515	345	PFL620	343	PPT420	346
P56300	266	PDT520	345	PFL620S	343	PPT515	346
P56350	266	PDT521	345	PFL630	343	PPT520	346
P56400	266	PDT530	345	PFL640	343	PPT530	346
P56450	266	PDT531	345	PFL660	343	PPT540	346
P56500	266	PDT532	345	PFL715	342	PPT715	345
P56550	266	PDT540	345	PFL720	342	PPT915S	346

<u>PART NO.</u>	<u>PG #</u>	<u>PART NO.</u>	<u>PG #</u>	<u>PART NO.</u>	<u>PG #</u>	<u>PART NO.</u>	<u>PG #</u>
PPT920S	346	R18011	242	R30375	95	S01050	59
PSA740	347	R18012	242	R30400	95	S01051	9
PSL031	345	R18013	242	R30600	95	S01052	9
PSL042	345	R18014	242	R40150	125	S01053	9
PSL132	345	R18015	242	R40200	125	S01055	8
PSL715S	341	R18016	242	R40300	125	S01056	9
PSL716S	341	R18017	242	R40400	125	S01057	9
PSL720	341	R18018	242	R45150	125	S01058	9
PSL730	341	R18019	242	R45200	125	S01060	58
PSL740	341	R18020	242, 272	R45300	125	S01061	58
PSL760	341	R18026	242	R45400	125	S01070	7.59
PSL815	343	R18027	242	R50150	125	S01071	7
PSL820	343	R18028	242	R50200	125	S01072	7
PSL830	343	R19003	272	R50300	125	S01073	7
PSL840	343	R19004	272	R50400	125	S01080	58
PSL916	342	R19005	272	R57150	125	S01084	7
PSL926	342	R19006	272	R57200	125	S01085	7
PSL936	342	R19099	272	R57300	125	S01086	7
PSL946	342	R19100	272	R57400	125	S01087	7
PSS140	345	R19102	272	R60001	129	S01088	8
PST114	344	R19103	272	R60002	129	S01089	8
PST115	344	R19104	272	R60003	129	S01090	8
PST120	344	R19202	272	R60004	129	S01091	8
PST121	344	R19203	272	R60050	95	S01092	8
PST122	344	R19204	272	R60075	95	S01093	8
PST123	344	R19206	272	R60100	95	S01094	8
PST130	344	R19302	272	R60125	95	S01095	8
PST131	344	R19303	272	R60150	95	S01096	8
PST132	344	R19304	272	R60200	95	S01151	9
PST140	344	R19305	272	R60250	95	S01152	9
PST141	344	R19306	272	R60300	95	S01153	9
PST142	344	R19307	272	R60375	95	S01155	8
PST143	344	R19402	272	R60400	95	S01156	9
PST160	344	R19403	272	R60600	95	S01157	9
PST164	344	R19404	272	R70150	125	S01158	9
PST232	345	R20001	167	R70200	125	S01184	7
PTA215	346	R20002	167	R70300	125	S01185	7
PTA221	346	R20003	167	R70400	125	S01186	7
PTA311	346	R20005	167	S01001	56	S01187	7
PTA315	346	R20006	167	S01002	56	S0130BN	9
PTA415	346	R20007	167	S01003	56	S0130RB	9
PTA420	346	R20008	167	S01004	56	S0130WB	9
PTC633	345	R20009	167	S01005	56	S0132BN	9
PTC644	345	R20100	168	S01008	56	S0132RB	9
PVT415	344	R20101	168	S01009	56	S0132WB	9
PVT420	344	R20102	168	S01010	7, 56	S0151BN	9
PVT430	344	R20104	167	S01013	57	S0151RB	9
PVT440	344	R20105	167	S01014	57	S0151WB	9
Q00200	426	R20107	167	S01015	57	S0152BN	9
R15050	240	R20108	167	S01016	57	S0152RB	9
R15075	240	R20109	167	S0101BN	7	S0152WB	9
R15100	125	R20110	167	S0101RB	7	S0153BN	9
R15101	125	R20111	167	S0101WB	7	S0153RB	9
R15107	125	R20112	167	S01020	57	S0153WB	9
R15108	125	R20113	167	S01025	57	S0155BN	8
R15109	125	R20150	168	S01030	9, 57	S0155RB	8
R15202	112	R20151	168	S01032	9, 57	S0155WB	8
R15204	112	R20152	168	S01035	9, 57	S0156BN	9
R16100	125	R20153	168	S01036	9	S0156RB	9
R16101	125	R20154	168	S01037	9	S0156WB	9
R16107	125	R30050	95	S01038	9, 57	S0157BN	9
R16108	125	R30075	95	S01039	57	S0157RB	9
R18001	242	R30100	95	S01040	57	S0157WB	9
R18005	242	R30125	95	S01041	57	S0158BN	9
R18006	242	R30150	95	S01042	57	S0158RB	9
R18007	242	R30200	95	S01044	57	S0158WB	9
R18008	242	R30250	95	S01045	57	S0184BN	7
R18009	242	R30300	95	S01049	57	S0184RB	7

<u>PART NO.</u>	<u>PG #</u>	<u>PART NO.</u>	<u>PG #</u>	<u>PART NO.</u>	<u>PG #</u>	<u>PART NO.</u>	<u>PG #</u>
S0184WB	7	S04024	84	S04242	83	S06018	297
S0185BN	7	S04025	84	S04243	83	S06019	297
S0185RB	7	S04026	84	S04244	83	S06021	419
S0185WB	7	S04027	26, 84	S04245	83	S08003	85
S0186BN	7	S04028	84	S04246	83	S08008	85
S0186RB	7	S04029	26, 84	S04247	83	S08012	85
S0186WB	7	S04030	84	S04248	83	S08020	4, 73
S0187BN	7	S04031	84	S04249	83	S08030	85
S0187RB	7	S04032	84	S04250	83	S08031	85
S0187WB	7	S04101	84	S04255	82	S08032	85
S0188BN	8	S04102	84	S04260	83	S08100	309
S0188RB	8	S04103	84	S04267	83	S10020	4
S0188WB	8	S04104	84	S04268	83	S10021	4
S0189BN	8	S04105	84	S04269	83	S10022	4
S0189RB	8	S04106	84	S04270	83	S10023	4
S0189WB	8	S04107	84	S04275	83	S10024	4
S0192BN	8	S04108	84	S04276	83	S10025	4
S0192RB	8	S04121	84	S04280	82	S10068	58
S0192WB	8	S04123	84	S04285	82	S10069	58
S0193BN	8	S04124	84	S04288	82	S10070	58
S0193RB	8	S04125	84	S04350	113	S10071	58
S0193WB	8	S04127	84	S04351	113	S10072	58
S0194BN	8	S04128	84	S04352	113	S10073	58
S0194RB	8	S04200	82	S04353	113	S10074	58
S0194WB	8	S04201	82	S04354	113	S10075	58
S0195BN	8	S04202	82	S04355	113	S10076	58
S0195RB	8	S04203	82	S04356	113	S10077	58
S0195WB	8	S04204	82	S04357	113	S10078	58
S0196BN	8	S04205	82	S04358	113	S10079	59
S0196RB	8	S04206	82	S04359	113	S10080	58
S0196WB	8	S04207	82	S04360	113	S10081	58
S02015	56	S04208	82	S04400	83	S10082	58
S02016	56	S04209	82	S04401	83	S10083	58
S02055	56	S04210	82	S04402	83	S10100	309
S02056	56	S04211	82	S04403	83	S10300	84
S02057	56	S04212	82	S04404	83	S10301	84
S02058	56	S04213	82	S04405	83	S10302	84
S02059	56	S04214	82	S04406	83	S10303	84
S02066	56	S04215	82	S04407	83	S10310	84
S02069	56	S04216	82, 418	S04408	83	S10311	84
S02070	56	S04217	82	S04409	83	S10312	84
S02071	56	S04217	418	S04410	83	S10313	84
S02072	56	S04218	82	S04411	83	S10314	84
S02073	56	S04219	82	S04412	83	S10315	84
S02074	56	S04219	418	S04413	83	S10316	84
S02100	57	S04220	82	S04414	83	S10317	84
S02150	56	S04221	82	S04415	83, 418	S10318	84
S02151	56	S04222	82	S04416	83	S10319	84
S02152	56	S04222	418	S04417	83	S10320	84
S02190	10, 56	S04223	82	S04418	83	S10321	84
S02193	10, 56	S04224	82	S04419	83	S10323	84
S02197	10, 56	S04225	82	S04420	83	S10324	84
S02198	10, 56	S04226	82	S04421	83	S10325	84
S02290	10, 56	S04227	82	S04422	83	S10326	84
S02293	10, 56	S04228	82	S04423	83	S10327	84
S02300	56	S04229	82	S04424	83	S10328	84
S03009	7	S04230	82	S04430	83	S10330	84
S03030	9	S04231	82	S04440	83	S10331	84
S03032	9	S04232	82	S04450	83	S10332	84
S03040	10	S04233	83	S04455	83	S10333	84
S03051	7	S04234	83	S05100	86	S10334	84
S03152	7	S04235	83	S05101	86	S10335	84
S03220	61	S04236	83	S05102	86	S10336	84
S03222	61	S04237	83	S05105	85	S10337	84
S04020	26, 84	S04238	83	S06014	297	S10338	84
S04021	84	S04239	83	S06015	297	S10339	84
S04022	26, 84	S04240	83	S06016	297	S10340	84
S04023	84	S04241	83	S06017	297	S10341	84

PART NO.	PG #	PART NO.	PG #	PART NO.	PG #	PART NO.	PG #
S1034BN	25	S14606	75, 336	S33002	118	S4211BN	24
S1034RB	25	S16003	118	S33003	118	S4211RB	24
S10351	25	S16005	118	S33004	118	S4211WB	24
S10355	84	S16006	118	S33005	118	S4212BN	24
S1035AP	25	S16009	118	S33006	118	S4212RB	24
S1035BB	25	S16012	118	S33007	118	S4212WB	24
S1035BN	25	S16018	118	S33010	118	S4213BN	24
S1035PS	25	S16024	118	S33011	118	S4213RB	24
S1035RB	25	S163566	118	S33012	118	S4213WB	24
S1035WB	25	S180032	118	S33013	118	S42220	23
S10361	25	S20009	118	S33016	118	S4222BN	23
S1036AP	25	S20012	118	S33021	118	S4222RB	23
S1036BN	25	S20015	305	S33022	118	S4222WB	23
S1036RB	25	S20021	305	S33023	118	S43021	24
S1036WB	25	S20031	305	S33318	118	S4302BN	24
S10371	25	S20041	305	S33518	118	S4302PB	24
S1037AP	25	S20100	305, 424	S36006	273	S4302RB	24
S1037BB	25	S20101	305, 424	S36007	273	S4302WB	24
S1037BN	25	S20102	305, 424	S36008	273	S43031	24
S1037CP	25	S20103	305, 424	S36009	273	S4303BN	24
S1037PS	25	S20104	305, 424	S36010	273	S4303PB	24
S1037RB	25	S20105	305, 424	S36011	273	S4303RB	24
S1037WB	25	S20106	305	S36090	273	S4303WB	24
S10381	25	S20200	305	S36091	273	S4311BN	24
S1038AP	25	S20201	305	S36095	273	S4311RB	24
S1038BB	25	S20202	305	S36096	273	S4311WB	24
S1038BN	25	S20203	305	S41001	297	S4312BN	24
S1038CP	25	S20204	305	S41002	297	S4312RB	24
S1038PS	25	S20300	305	S41003	297	S4312WB	24
S1038RB	25	S20301	305	S41006	297	S4314BN	24
S1038WB	25	S20302	305	S41007	297	S4314RB	24
S1039BN	25	S22001	104	S41300	297	S4314WB	24
S1039CP	25	S22002	104	S41301	297	S44000	401
S1039RB	25	S22003	104	S41302	297	S44002	25
S1135BN	25	S22004	104	S41303	297	S44003	25
S1135RB	25	S22005	104	S41306	297	S44005	25
S1136BN	25	S22006	104	S41307	297	S4401BN	26
S1136RB	25	S25150	231	S41308	297	S4401RB	26
S1137BN	25	S25200	231	S41348	292, 404	S4401WB	26
S1137RB	25	S25250	231	S41348	419	S4402BN	26
S1138BN	25	S25300	231	S41349	292	S4402RB	26
S1138RB	25	S25350	231	S41350	292	S4402WB	26
S12005	55	S25400	231	S41351	292	S4403BN	26
S13130	55	S26001	99	S41352	292	S4403RB	26
S13140	55	S26002	99	S41353	292	S4403WB	26
S13240	55	S26004	231	S41355	292	S4405BN	26
S14001	74, 336	S26005	231	S41356	292	S4405RB	26
S14002	74, 336	S26006	231	S41357	292	S4405WB	26
S14003	336	S26007	231	S41364	292, 404	S45001	3
S14003	74	S26008	231, 275	S41364	419	S49001	287, 425
S14004	336	S26009	231	S41450	292, 404	S49002	287
S14004	74	S26010	231	S41450	419	S49003	288
S14005	74, 336	S26011	231	S41452	292, 404	S49005	423
S14006	74, 336	S26012	231	S41452	419	s49005	288
S14007	3, 74, 336	S26014	231	S41453	292, 404	S49005	425
S14008	74, 337	S26015	231	S41453	419	S49006	423
S14009	3, 74, 337	S26016	231	S41455	292, 404	s49006	288, 425
S14010	74, 337	S26017	231	S41455	419	S49007	423
S14011	74	S26100	99	S42021	24	s49007	288, 425
S14014	75, 337	S27001	99	S4202BN	24	S49008	423
S14030	75	S27002	99	S4202PB	24	s49008	288
S1407BN	3	S30012	126	S4202RB	24	S49008	425
S1407RB	3	S30024	126	S4202WB	24	S49010	287
S1407WB	3	S30800	300	S42031	24	S49012	287
S1409BN	3	S30801	300	S4203BN	24	S49013	287
S14103	74, 336	S30802	300	S4203PB	24	S49036	423
S14250	75, 336	S30803	300	S4203RB	24	S49036	288
S14251	75, 336	S33001	118	S4203WB	24	S49042	238

<u>PART NO.</u>	<u>PG #</u>	<u>PART NO.</u>	<u>PG #</u>	<u>PART NO.</u>	<u>PG #</u>	<u>PART NO.</u>	<u>PG #</u>
S49043	238	S55112	271	S62001	282	T0100BN	28
S49044	238	S55113	271	S62002	282	T0100PB	28
S49048	288	S55114	271	S62003	282	T0100RB	28
S49052	238	S55115	271	S62004	282	T0100WB	28
S49053	238	S55122	271	S62005	282	T01010	45
S49054	238	S55123	271	S62100	81	T01012	45
S49062	238	S55124	271	S62101	81	T01015	27
S49063	238	S55192	271	S62304	81	T01016	45
S49064	238	S55193	271	S63200	81	T01017	27
S49072	238	S55194	271	S63300	81	T01020	44
S49073	238	S55240	271	S63400	81	T01021	27
S49074	238	S55349	86, 271	S80200	290, 400	T0102BN	27
S49082	238	S55350	86, 271	S80201	289, 400	T0102RB	27
S49083	238	S55352	86, 271	S92001	162	T0102WB	27
S49084	238	S55353	86, 271	S92025	162	T01030	44
S49092	238	S55354	86, 271	S92030	162	T01031	27
S49093	238	S55902	51, 184	S92031	162	T01032	27
S49094	238	S55903	51, 184	S95010	301	T01033	27
S49136	288	S55950	51, 184	S95011	301	T01034	44
S49148	288	S55951	51, 184	S95012	300	T01035	27
S49200	423	S55952	51, 184	S95014	300	T01036	27
S49200	287	S55953	51, 184	S95015	302	T01037	27
S49201	287	S57034	270	S95016	300	T01040	45
S49236	423	S57035	270	S95100	301	T01042	44
S49236	288	S58050	73	S95101	301	T01043	27
S49400	289	S58051	73	S95102	295	T01044	27
S49401	289, 401	S58052	73	S95103	295	T01045	27
S49402	289, 401	S58053	73	S95104	295	T01048	44
S49412	289, 401	S58101	73	S95105	295	T01049	27
S49413	289	S59002	238	S95106	295	T01050	44
S49416	289	S59003	238	S95200	301	T01051	27
S49417	289	S59004	238	S95250	396, 416	T01052	27
S49421	289	S59010	239	S95251	396, 416	T01053	27
S49422	289	S59011	239	S95700	416	T0105BN	28
S49423	289	S59012	239	S95701	301, 426	T0105RB	28
S49425	289	S59042	239	S95709	301	T0105WB	28
S49427	289	S59043	239	S95710	300	T01060	44
S49429	289	S59044	239	S95711	300	T01061	26
S49430	289, 401	S59052	239	S95712	301	T01062	44
S49431	289	S59053	239	S95713	301	T01064	44
S49432	289	S59054	239	S95793	301, 426	T01065	27
S49433	289, 401	S59062	239	S95794	301	T01066	45
S49434	289, 401	S59063	239	S95795	301	T01067	28
S49489	290	S59064	239	S95800	305, 405, 414	T01068	44
S49490	290	S59072	239	S96012	300	T01070	44
S49500	290	S59073	239	S96014	300	T01071	26
S49501	290	S59074	239	S96016	300	T01072	45
S50001	396	S59082	239	S99100	57	T01073	27
S50002	396, 415	S59083	239	S994050	57	T01074	44
S50060	423	S59084	239	S995040	57	T01075	26
S50060	288	S59092	239	S996050	57	T01080	45
S50061	423	S59093	239	S996080	57	T01081	45
S50061	288	S59094	239	STACKOUT	426	T0108BN	27
S50062	288	S59102	238	T00002	271	T0108RB	27
S50063	288	S59103	238	T00003	271	T0108WB	27
S51001	104	S59104	238	T00005	271	T01099	44
S51002	104	S59302	238	T00006	271	T01100	26, 45
S51080	104	S59303	238	T00009	271	T01101	26
S51120	104	S59304	238	T01000	28	T01102	26
S55001	238	S59310	239	T01001	418	T01103	26
S55002	238	S59311	239	T01001	44	T01181	27
S55004	271	S59312	239	T01002	44	T01200	44
S55010	271	S59402	238	T01003	26	T01201	44
S55050	271	S59403	238	T01004	26	T01330	28
S55075	271	S60002	239, 271	T01005	44	T0133BN	28
S55100	270	S60003	239, 271	T01006	26	T0133RB	28
S55101	270	S60004	239, 271	T01007	26	T0133WB	28
S55104	271	S60005	239	T01008	26	T018BN	28

PART NO.	PG #	PART NO.	PG #	PART NO.	PG #	PART NO.	PG #
T018RB	28	T06800	99	T26252	117	T35003	97
T018WB	28	T07150	98	T26312	117	T35004	97
T02005	51	T07200	98	T26313	117	T35201	97
T02020	50	T07300	98	T26375	117	T35202	97
T02021	50	T07400	98	T26376	117	T35203	97
T02022	50	T08003	12	T26377	117	T35204	97
T02023	50	T08004	12	T26498	117	T35206	97
T02024	50	T08012	12	T26500	117	T36150	97
T02025	46	T08013	12	T26625	117	T36200	97
T02026	50	T08021	13	T26626	117	T36300	97
T02027	50	T08113	12	T26750	117	T36400	97
T02028	48	T0812BN	12	T26875	117	T36600	97
T02035	50	T0812RB	12	T27125	117	T37001	96
T02036	50	T0812WB	12	T27188	117	T37002	96
T02037	50	T0813BN	13	T27250	117	T37003	96
T02038	50	T0813PW	13	T27313	117	T37004	96
T02039	50	T0813RB	13	T27375	117	T37006	96
T02050	50	T0813WB	13	T27438	117	T37008	96
T02051	50	T10014	61	T27500	117	T38006	129
T02052	50	T10016	61	T27625	117	T38010	129
T02053	50	T10216	61	T30002	98	T38038	129
T02062	50	T12001	123	T30034	98	T38106	129
T02064	50	T12006	129	T30046	98	T38110	129
T02065	50	T12010	129	T30068	98	T39002	97
T02066	49	T12050	129	T30102	98	T39003	97
T02067	50	T12106	129	T30203	98	T39004	97
T02070	49, 395, 418	T12110	129	T30304	98	T39006	97
T02075	49	T16002	103	T31000	96	T39008	97
T03008	49	T16004	103	T31001	96	T39010	97
T04001	26	T16100	103	T31002	96	T39012	97
T05002	13, 61	T17002	103	T31003	96	T40001	131
T05003	12, 61	T17004	103	T31004	96	T40002	131
T05010	61	T17101	103	T31006	96	T40003	131
T05011	13, 61	T17102	103	T32001	97	T40004	131
T05012	12, 61	T17104	103	T32002	97	T40005	131
T05013	13, 61	T18201	103	T32003	97	T40007	131
T05021	13, 61	T18202	103	T32004	97	T40008	131
T05023	61, 62	T19118	103	T32006	97	T41001	293
T05025	61	T19119	103	T32008	97	T41002	293
T05026	61	T19122	103	T32011	97	T41003	293
T05029	61	T19125	103	T32022	97	T41004	293
T0521AB	13	T19222	103	T32033	97	T41005	293
T0521AL	13	T19342	103	T32044	97	T41006	293
T0521AN	13	T19345	103	T33001	97	T41007	293
T0521BI	13	T20020	103, 405, 416	T33002	97	T41008	293
T0521BL	13	T20023	103, 405, 414, 416	T33003	97	T41009	293
T0521BN	13	T20030	103	T33004	97	T45002	98
T0521BS	13	T20040	103, 405	T33152	97	T45003	98
T0521PN	13	T20041	103, 405	T33200	98	T45010	97
T0521PS	13	T20050	103, 405	T33300	98	T45012	97
T0521PW	13	T21001	275	T33304	97	T45150	97
T0521RB	13	T21002	275	T33400	98	T45200	97
T0521WB	13	T21003	275	T34001	96	T45300	97
T06001	99, 335	T21004	275	T34002	96	T45400	97
T06002	99, 335	T21062	275	T34003	96	T45600	97
T06003	99, 335	T21063	275	T34004	96	T45800	97
T06004	99, 335	T21064	275	T34006	96	T46200	97
T06024	99	T25250	117	T34008	96	T46300	97
T06025	99	T25312	117	T34012	96	T46400	97
T06050	99	T25375	117	T34013	96	T50001	305, 425
T06200	99	T25500	117	T34014	96	T55002	275
T06250	99	T25625	117	T34150	96	T55003	275
T06300	99	T26000	117	T34200	96	T55004	275
T06320	99	T26124	117	T34300	96	T55012	275
T06400	99	T26125	117	T34350	96	T55013	275
T06430	99	T26186	117	T34400	96	T55014	275
T06600	99	T26187	117	T35001	97	T55022	275
T06640	99	T26250	117	T35002	97	T55033	275

<u>PART NO.</u>	<u>PG #</u>	<u>PART NO.</u>	<u>PG #</u>	<u>PART NO.</u>	<u>PG #</u>	<u>PART NO.</u>	<u>PG #</u>
T55044	275	T74005	71, 324	T86054	71	V95008	313
T56002	275	T74006	71, 324	T86055	71	V95010	313
T56003	275	T74010	68, 334	TB4000	422	V95012	313
T56004	275	T74011	68, 334	TB4100	422	V95015	313
T56012	275	T75000	71	TB4200	423	V96002	313
T56013	275	T75001	71	TB4300	423	V96003	313
T56014	275	T75125	71, 335	TB4400	424	V96004	313
T56022	275	T75150	71, 335	TB4500	424	V96005	313
T56033	275	T75151	71, 335	TB5000	418	V96006	313
T56044	275	T75250	71	TB5100	419	V96008	313
T60000	123	T76125	71, 335	TB5200	419	V96010	313
T60001	123	T76150	335	TB5300	420	V96012	313
T60003	123	T76150	71	TB5400	420	V96015	313
T60004	123, 401, 414	T76151	71, 335	TB5500	421	V97002	313
T60005	124	T76250	71	TB5600	421	V97003	313
T60006	124	T77012	71, 334	TOOLSPIN	425	V97004	313
T60007	304	T77013	71, 334	U003WD00	383	V97005	313
T60060	314	T77014	71, 334	U004WD00	383	V97006	313
T60060	281, 422, 425	T77020	71, 334	U100500	386	V97008	313
T60065	281, 314	T77125	70, 334	U100600	386	V97010	313
T60066	281, 314	T77138	70, 334	U100700	386	V97012	313
T60080	281, 314	T77150	70, 334	U100800	386	V97015	313
T60081	281, 314	T77151	70, 334	U1008TK00	386	V98002	313
T60100	302	T77152	70, 334	U300V00	381	V98003	313
T60101	302	T77200	70, 334	U95001	314	V98004	313
T60102	302	T78012	71, 334	U95002	314	V98005	313
T60103	302	T78013	71, 334	U95003	314	V98006	313
T60104	302	T78014	71, 334	U95004	314	V98008	313
T60105	302	T78020	71, 334	U95005	314	V98010	313
T60106	302	T78125	70, 334	U95006	314	V98012	313
T60107	302	T78150	70, 334	U95008	314	V98015	313
T60108	302	T78151	70, 334	U95010	314		
T60110	302	T78152	70, 334	U95012	314		
T60111	302	T78200	70, 334	U95015	314		
T60121	302	T79000	70	U95211	314		
T60122	302	T79125	71, 335	U95320	314		
T60123	302	T79150	71, 335	U95430	314		
T60124	302	T79151	71, 335	U97001	314		
T60125	302	T79152	71, 335	U97002	314		
T60126	302	T79200	71, 335	U97003	314		
T60127	302	T79201	71, 335	U97004	314		
T60130	302, 402	T80125	71, 335	U97005	314		
T63106	275	T80135	71, 335	U97006	314		
T64540	275	T80150	71, 335	U97008	314		
T73001	10, 81	T80151	71, 335	U97010	314		
T73002	10, 81	T80160	71, 335	U99001	315		
T73003	10, 81	T80200	71, 335	U99002	315		
T73004	10, 81	T81150	71, 335	U99003	315		
T73125	136	T82125	70, 334	U99004	315		
T73138	136	T82150	70, 334	U99005	315		
T73150	136	T83150	70, 334	U99006	315		
T73175	136	T84125	70, 334	U99008	315		
T73200	136	T84150	70, 334	U99010	315		
T73300	23	T84151	70, 334	U99110	315		
T7330BN	23	T84200	70, 334	U99211	315		
T7330PB	23	T85050	71	U99220	315		
T7330RB	23	T85051	71	U99320	315		
T7330WB	23	T85052	71	U99330	315		
T73815	10	T85053	71	U99440	315		
T73815	81	T85054	71	U99550	315		
T73816	10, 81	T85055	71	U99660	315		
T73817	10, 81	T85056	48	U99880	315		
T73818	10, 81	T85057	48	V94004	313		
T74001	71, 324	T85125	70, 334	V95002	313		
T74002	71, 324	T85150	70, 334	V95003	313		
T74003	71, 324	T86050	71	V95004	313		
T74004	71	T86052	71	V95005	313		
T74004	324	T86053	71	V95006	313		



JONES STEPHENS KITTING

PICK IT • KIT IT • SHIP IT

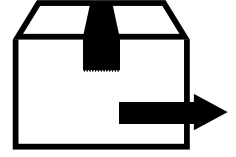
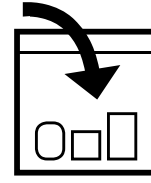

SAVE TIME AND LABOR COST ON THE JOB!

Build your own kit by selecting products in each section.
Have exactly what you need on-hand for each project!

Contractor Name: _____ Contact Info: _____

Select One: Project Kit Project Name: _____
 Everyday Kit

Number of Kits Needed: _____ Lavatory Kits _____ Water Closet Kits _____ Water Heater Kits _____ Kitchen Kits

LAVATORY KIT			SIZE	CONNECTION TYPE	MATERIAL OR FINISH	QTY (per kit)
Supply Stops	<input type="checkbox"/> Straight <input type="checkbox"/> Angle	<input type="checkbox"/> Quarter-Turn <input type="checkbox"/> Multi-Turn				
Supply Tubes	<input type="checkbox"/> With Ferrule <input type="checkbox"/> NO Ferrule	<input type="checkbox"/> Flexible <input type="checkbox"/> Rigid				
Escutcheons	<input type="checkbox"/> Low Pattern <input type="checkbox"/> Box Pattern <input type="checkbox"/> Bell Pattern	<input type="checkbox"/> White Plastic <input type="checkbox"/> Chrome Plated Plastic				
Tubular Traps	<input type="checkbox"/> P-Trap <input type="checkbox"/> S-Trap	<input type="checkbox"/> With Cleanout <input type="checkbox"/> NO Cleanout				
Faucets	<input type="checkbox"/> Single Handle <input type="checkbox"/> Double Handle					
Tubular Extensions	<input type="checkbox"/> Slip Joint <input type="checkbox"/> Threaded <input type="checkbox"/> Solder End	<input type="checkbox"/> 17 GA <input type="checkbox"/> 20 GA <input type="checkbox"/> 22 GA				
OTHER PRODUCTS						

WATER CLOSET KIT			SIZE	CONNECTION TYPE	MATERIAL OR FINISH	QTY (per kit)
Supply Stops	<input type="checkbox"/> Straight <input type="checkbox"/> Angle	<input type="checkbox"/> Quarter-Turn <input type="checkbox"/> Multi-Turn				
Supply Tubes	<input type="checkbox"/> With Ferrule <input type="checkbox"/> NO Ferrule	<input type="checkbox"/> Flexible <input type="checkbox"/> Rigid				
Escutcheons	<input type="checkbox"/> Low Pattern <input type="checkbox"/> Box Pattern <input type="checkbox"/> Bell Pattern	<input type="checkbox"/> White Plastic <input type="checkbox"/> Chrome Plated Plastic				
Wax Rings	<input type="checkbox"/> With Flange <input type="checkbox"/> NO Flange					
Closet Bolts	<input type="checkbox"/> Brass <input type="checkbox"/> Brass Plated	<input type="checkbox"/> Oval Washer <input type="checkbox"/> Round Washer				
Shims	<input type="checkbox"/> Flexible <input type="checkbox"/> Rigid					
Repair Rings	<input type="checkbox"/> Metal Only					
OTHER PRODUCTS						



WATER HEATER KIT			SIZE	CONNECTION TYPE	MATERIAL OR FINISH	QTY (per kit)
Water Heater Connectors	<input type="checkbox"/> Braided <input type="checkbox"/> Corrugated	<input type="checkbox"/> Copper <input type="checkbox"/> Stainless Steel				
Gas Connectors	<input type="checkbox"/> Coated <input type="checkbox"/> Uncoated	<input type="checkbox"/> With Ball Valve <input type="checkbox"/> NO Ball Valve				
Dielectric Unions	<input type="checkbox"/> FIP x SWT <input type="checkbox"/> MIP x SWT					
Dielectric Nipples	<input type="checkbox"/> 3" Length <input type="checkbox"/> 4" Length <input type="checkbox"/> 6" Length					
Water Heater Pans	<input type="checkbox"/> Aluminum <input type="checkbox"/> Galvanized <input type="checkbox"/> Plastic					
Grounding Kits	<input type="checkbox"/> 12" Copper Wire <input type="checkbox"/> 24" Copper Wire					
OTHER PRODUCTS						

KITCHEN KIT			SIZE	CONNECTION TYPE	MATERIAL OR FINISH	QTY (per kit)
Supply Stops	<input type="checkbox"/> Straight <input type="checkbox"/> Angle	<input type="checkbox"/> Quarter-Turn <input type="checkbox"/> Multi-Turn				
Supply Tubes	<input type="checkbox"/> With Ferrule <input type="checkbox"/> NO Ferrule	<input type="checkbox"/> Flexible <input type="checkbox"/> Rigid				
Escutcheons	<input type="checkbox"/> Low Pattern <input type="checkbox"/> Box Pattern <input type="checkbox"/> Bell Pattern	<input type="checkbox"/> White Plastic <input type="checkbox"/> Chrome Plated Plastic				
Tubular Traps	<input type="checkbox"/> P-Trap <input type="checkbox"/> S-Trap	<input type="checkbox"/> With Cleanout <input type="checkbox"/> NO Cleanout				
Faucets	<input type="checkbox"/> Single Handle <input type="checkbox"/> Double Handle					
Tubular Extensions	<input type="checkbox"/> Slip Joint <input type="checkbox"/> Threaded <input type="checkbox"/> Solder End	<input type="checkbox"/> 17 GA <input type="checkbox"/> 20 GA <input type="checkbox"/> 22 GA				
Dishwasher Connectors	<input type="checkbox"/> Stainless Steel <input type="checkbox"/> Nylon	<input type="checkbox"/> With 90° Elbow <input type="checkbox"/> NO Elbow				
Outlet Wastes	<input type="checkbox"/> Slip Joint <input type="checkbox"/> Direct Connection	<input type="checkbox"/> Center <input type="checkbox"/> End				
Sink Strainers	<input type="checkbox"/> Deep <input type="checkbox"/> Shallow <input type="checkbox"/> Junior					
Easy Connect Tees	<input type="checkbox"/> 3/8" F Comp x 3/8" M Comp x 3/8" M Comp <input type="checkbox"/> 3/8" F Comp x 3/8" M Comp x 1/4" M Comp					
OTHER PRODUCTS						

Thank you for your order!

Jones Stephens Sales Support will contact you to review within 24 hours of receipt of this form. You will have pricing and delivery within 24 hours. Product will be picked to ship within 48 hours, depending on quantity and availability.

